

County of Los Angeles Department of Public Works

HYDROLOGIC REPORT

2014 – 2015



Water Resources Division

TABLE OF CONTENTS

Appendices.....	(ii)
Acknowledgments.....	4
Introduction.....	5
Los Angeles County.....	6
Flood Control District	9
PRECIPITATION	
Rainfall Indices.....	11
Standard Rain Gage Stations During Water Year 2014-2015.....	12
Daily Rainfall Summary.....	15
Location Map.....	16
EVAPORATION	
Active Stations	17
Monthly Summary.....	18
Location Map.....	19
RUNOFF	
Index of Stream Gaging Stations	21
Stream Gaging Station Information	23
Daily Discharge	23
Stream Gaging Station Peak Flow	23
Location Map	24
RESERVOIRS	
Yearly Reservoir Operation Summary	26
Reservoir Information	27
Location Map	42
EROSION CONTROL	
Location Map	44
Debris Basin – Design Data	45
Yearly Debris Production Summary	49
WATER CONSERVATION	
Conserving The Waters	52
Imported Water	52
Recycled Water	53
Seawater Barrier Projects	53
Seasonal Data and Maps	53
Groundwater Basins and Groundwater Recharge	54
<u>SUMMARY</u>	
Public Works Facilities	58
Other Facilities	58
Total Monthly Water Conserved	58
Imported Water Outlet Releases	58
Reclaimed Water	58
Ground Water Fluctuation	58
Keywell Location Map	59

Appendices

DAILY RAINFALL SUMMARY	A
STREAM GAGING STATION INFORMATION	B
DAILY DISCHARGE	C
STREAM GAGING STATION PEAK FLOW	D
YEARLY RESERVOIR OPERATION SUMMARY	E
EROSION CONTROL - LOCATION MAP	F
SUMMARY OF WATER CONSERVATION	
Public Works Facilities	G
Other Facilities	H
Total Monthly Water Conserved	I
Imported Water Outlet Releases	J
Reclaimed Water	K
Ground Water Fluctuation	L

ACKNOWLEDGMENT

This report was prepared by the County of Los Angeles Department of Public Works, Water Resources Division under the direction of Christopher Stone, Assistant Deputy Director. The following staff contributed to the completion of this report:

General Supervision and Coordination

Iraj Nasser, Hydrology Section Head
Eric Batman, Operations Section Head

Data Collection and Processing

Operations Section

William Saunders

Keith Hala
Irene Wong

Haris Harouny
Fred Lai

Don Wilson
Sarkis Zargaryan
Anthony Ward
Tony Trujillo

Janet Lozano
Liang Weng
Thien Nguyen
Garry Allen

Hydrologic Development / Hydraulic Studies Unit

Martin Araiza

Rodney Brown
Miguel Osorio
Steven Chang

Arthur Gotingco
Andrew Lee

Instrumentation and Capital Projects Unit

Ramil Parial

Thompson Nguyen

Steve Carrillo

Luong Quang
Robert Fuentes

Roberto Banuelos
Nabor Arce

** DISCLAIMER **

The information contained on this report was valid at the time of publication. The Department of Public Works reserves the right to make changes at any time and without notice, and assumes no liability for any damages incurred directly or indirectly as a result of changes errors, omissions or discrepancies.

INTRODUCTION

This report discusses hydrologic data relative to the County of Los Angeles for the period beginning October 1, 2014, and ending September 30, 2015. Public Works has revised the format of this report to provide users with more useful data and a more efficient means of utilizing the data. This report is organized into 8 sections.

LOS ANGELES COUNTY

This section provides a brief discussion on the topography, geology, land use, climate, hydrometeorological, and runoff characteristics of the [County of Los Angeles](#).

RUNOFF

The [Runoff](#) Section provides mean daily and peak annual flow rate data for 62 active [stream gaging stations](#) operated by Public Works. Annual summaries for each of these stations are also contained in this section. Unpublished stream flow data are on file at Public Works.

FLOOD CONTROL DISTRICT

This section provides a brief discussion on floods in the County, the subsequent formation of the Los Angeles County [Flood Control District](#), and its two main tasks under the Flood Control Act - flood control and water conservation. The responsibilities and authority vested in the District were transferred to Public Works in 1985.

RESERVOIRS

The [Reservoir](#) Section provides a summary of annual inflow, outflow, and storage data for 14 [dams and reservoirs](#). Daily inflow values are on file at Public Works.

PRECIPITATION

The [Precipitation](#) Section provides daily and annual rainfall data collected by Public Works' active standard [rain gage stations](#). Unpublished rainfall data are on file at Public Works.

EROSION CONTROL

The [Erosion Control](#) Section provides debris basin design data, debris basin production summary, and debris production history for 118 debris basins owned and operated by Public Works.

EVAPORATION

The Evaporation Section contains data for 15 [active evaporation stations](#). Unpublished evaporation data from previous years are on file at Public Works. Unpublished information may be obtained by contacting:

WATER CONSERVATION

The [Water Conservation Section](#) provides data for 27 groundwater recharge facilities. This section contains data on the water conserved at various facilities and the water injected at the seawater barrier projects. Historical well level data for key wells are also contained in this section. Unpublished water conservation data from previous years are on file at Public Works.

County of Los Angeles Department of Public Works
Water Resources Division
P.O. Box 1460
Alhambra, CA 91802-1460
(626) 458-6120

LOS ANGELES COUNTY

TOPOGRAPHY

The County of Los Angeles covers an area of 4,083 square miles and measures approximately 66 miles in the east - west and 73 miles in the north - south directions.

The terrain within the County can be classified in broad terms as being 25 percent mountainous; 14 percent coastal plain; and 61 percent hills, valleys, or deserts. Relief of the terrain ranges from sea level to a maximum elevation of 10,000 feet. The coastal plain is generally of mild slope and contains relatively few depressions or natural ponding areas. The slopes of main river systems crossing the coastal plain, such as the San Gabriel River, Los Angeles River, and Ballona Creek, range from 4 to 14 feet per mile.

Topography in the mountainous area is generally rugged with deep, V-shaped canyons separated by sharp dividing ridges. Steep walled canyons with side slopes of 70 percent or more are common. The gradient of principal canyons in the San Gabriel Mountains ranges from 150 to 850 feet per mile. Mountain ranges are aligned in a general east-west direction with the dominant range being the San Gabriel Mountains. The majority of mountain ridges lie below Elevation 5,000 feet. The total area above this level is approximately 210 square miles.

GEOLOGY - SOILS

Igneous, metamorphic, and sedimentary rock groups are all present within the County. The San Gabriel Mountains and Verdugo Hills are composed primarily of highly fractured igneous rock, with large areas of granitic rock formation being exposed. Faulting and deep weathering have produced porous zones in the rock formation; however, rock masses have produced a comparatively shallow soil mantle due to the steepness of slopes which accelerates erosion of the fine material.

Other mountains and hilly reaches are composed primarily of folded and faulted sedimentary rocks, including shale, sandstone, and conglomerate. Residual soils in these areas are shallow and generally less pervious than those of the San Gabriel Mountain range.

Valley and desert soils are alluvial and vary from coarse sand and gravel near canyon mouths to silty clay, clay and sand and gravel in lower valleys and the coastal plain. The alluvial fill has accumulated by repeated deposition of sediments to depths as great as several thousand feet. This fill is quite porous in areas of relatively low clay content. Geologic structures and irregularities in the underlying bedrock divide the alluvium into several groundwater basins. Valley soils are generally well drained but there are a few areas containing perched water.

LAND USE

The principal vegetative cover of upper mountain areas consists of various species of brush and shrubs known as chaparral. Most trees found on mountain slopes are oak, with alder, willow, and sycamore found along streambeds at lower elevations. Pine, cedar, and juniper are found in ravines at higher elevations and along high mountain summits.

The chaparral is extremely flammable, and extensive burns of the mountain vegetation frequently occur during dry, low-humidity weather accompanied by high winds. Chaparral has the ability to sprout following fire and grows rapidly to re-establish the watershed cover within a period of 5 to 10 years.

Grasses are the principal natural vegetation on the hills. Much of the hill land and nearly all of the valley land in the densely populated portion of the County south of the San Gabriel Mountains has been converted to urban and suburban use. Development of the Santa Clarita Valley and desert areas to the north of the San Gabriel Mountains is sparse at present but is proceeding rapidly.

CLIMATE

The climate within the County varies between subtropical on the Pacific Ocean side of the San Gabriel Mountain range to arid in the Mojave Desert. Nearly all precipitation occurs during the months of December through March. Precipitation during summer months is infrequent, and rainless periods of several months are common. Snowfall at elevations above 5,000 feet is frequently experienced during the winter storms, but the snow melts rapidly except on higher peaks and the northern slopes. Snow is rarely experienced on the coastal plain.

January and July are the coldest and warmest months of the year, respectively. At the Los Angeles civic center, the 30-year average daily minimum temperature for January is 48 degrees (Fahrenheit) above zero. The average daily maximum temperature for July is 84 degrees. At Mount Wilson (Elevation 5,850 feet), the 30-year average daily minimum temperature for January is 35 degrees above zero and the average daily maximum temperature for July is 80 degrees.

HYDROMETEOROLOGIC CHARACTERISTICS

Coastal and Mountain Areas

Precipitation (rainfall) in the Los Angeles area occurs primarily in the form of winter orographic rainfall associated with extra tropical cyclones of North Pacific origin. Major storms consist of one or more frontal systems and occasionally last four days or longer. Air masses and frontal systems associated with major storms commonly extend for 500 to 1,000 miles in length and produce rainfall simultaneously throughout the County. Major storms approach Southern California from the west or northwest with southerly winds which continue until frontal passage. The mountain ranges lie directly across the path of the inflow of warm, moist air, and orographic effects greatly intensify precipitation.

The seasonal normal rainfall in the County of Los Angeles ranges from 27.50 inches in the San Gabriel Mountains to 7.83 inches in the desert. The average annual rainfall for the County is 15.65 inches.

The effects of snowmelt upon flood runoff are of significance in the few cases when warm spring rains from southerly storms fall on a snowpack. During major storms, temperatures throughout the County may remain above freezing. Average individual storm rainfall amounts and intensities conform to a fairly definite aerial pattern which reflects general effects of topographic differences.

Desert Areas

Summer convective rainfall is principally experienced in the upper San Gabriel Mountains and the Mojave Desert regions. In many desert areas, the most serious flooding occurs as a result of summer convective storms.

Mountain Areas

In mountain areas, the steep canyon slopes and channel gradients promote a rapid concentration of storm runoff. Depression storage and detention storage effects are minor in the rugged terrain. Soil moisture during a storm has a pronounced effect on runoff from the porous soils supporting a good growth of deep-rooted vegetation such as chaparral. Soil moisture deficiency is greatest at the beginning of a rainy season, having been depleted by the evapotranspiration process during the dry summer

months. Precipitation during periods of soil moisture deficiency is nearly entirely absorbed by soils, and except for periods of extremely intense rainfall, significant runoff does not occur until soils are wetted to capacity. Due to high infiltration rates and porosity of mountain soils, runoff occurs primarily as subsurface flow or interflow in addition to direct runoff. Spring or base flow is essentially limited to portions of the San Gabriel Mountain range. Consequently, most streams in the County are intermittent.

Runoff from a mountain watershed recently denuded by fire exceeds that for the unburned state due to greatly increased quantities of inorganic debris present in the flow and increased direct runoff resulting from lowered infiltration rates. Debris production from a major storm has amounted to as much as 223,000 cubic yards per square mile of watershed. Boulders up to eight feet in diameter have been deposited in valley areas a considerable distance from their source.

Debris quantities equal in volume to the storm runoff (100% percent bulking) have been recorded in major storms. Where debris-laden flow traverses an alluvial fill unconfined by flood control works, flood discharges follow an unpredictable path across the debris cone formed at the canyon mouth.

Hill and Valley Areas

In hill areas, runoff concentrates rapidly from the generally steep slopes; however, runoff rates from undeveloped hill areas are normally smaller than those from mountain areas of the same size. In those hill areas which have been developed for residential use, concentration times become considerably decreased due to drainage improvement, and runoff volumes and rates have increased due to increased imperviousness. On the other hand, erosion is controlled and debris is minimized from storm flows. Debris production rates from undeveloped hill areas are normally smaller than those from mountain areas of the same size.

In highly developed valley areas, local runoff volumes have increased as the soil surface has become covered by impervious materials. Peak runoff rates for valley areas have also increased due to elimination of natural ponding areas and improved hydraulic efficiency of water carriers such as streets and storm drain systems

LOS ANGELES COUNTY FLOOD CONTROL DISTRICT

Flood Control & Water Conservation

FLOODS – *An Old Story....*

Floods in the County of Los Angeles have been recorded as far back as the days of the Mission Padres. For centuries waters have swept out of the San Gabriel Mountains causing extensive property damage and taking a great toll of lives. Such a flood occurred in 1914 causing over \$10 million in property damage and taking many lives. As a result, the State legislature in 1915 enacted the statute creating the Los Angeles County Flood Control District. The responsibilities and authority vested in the Flood Control District were, in 1985, transferred to and are now part of the County of Los Angeles Department of Public Works.

Public Works, under the Flood Control Act, has two tasks:

1. Flood Control.
2. Water Conservation.

FLOOD CONTROL

Successful early bond issues financed the construction of dams built in the San Gabriel Mountains and foothills to impound storm waters until they could be safely released. Debris basins were constructed to trap eroded materials which had caused terrible damage in the past. Flood channel improvements were undertaken to confine the waters and convey them safely through the urbanized areas to the ocean.

District engineers prepared a Comprehensive Plan in the early 1930s, which would control flooding and save as much of the water as practicable when fully implemented. Federal legislation in 1936 brought the U.S. Army Corps of Engineers into the local flood control picture. Since that time, the two agencies have been jointly pursuing implementation of the Comprehensive Plan. Public Works also cooperates with the U.S. Natural Resources Conservation Service and Forest Service in erosion control.

WATER CONSERVATION

In addition to its flood control program, Public Works has the equally important mission of conserving as much of the storm and other waste waters as practicable. The use of water conservation facilities in or adjacent to river channels and their tributaries permits water to be percolated into groundwater aquifers or basins for later pumping and supply to consumers. These water conservation facilities are located in areas where the underlying soils are composed of porous sands and gravel formations. Some are shallow and resemble rice paddies, while others are deep basins which were once gravel pits.

The importance of this activity is apparent when it is realized that about 30 to 40 percent of the water used in the County is pumped from groundwater supplies. The growth of the County, combined with periodic droughts, seriously depleted these supplies on numerous occasions throughout the history of the County.

Other major conservation efforts by Public Works include combating the serious salt water intrusion into groundwater supplies inland from the Pacific Ocean and utilizing imported and reclaimed water to help replenish groundwater supplies.

ORGANIZED TO THE JOB

Day-to-day administration of Public Works affairs is vested in the Director of Public Works who is appointed by and responsible to the Los Angeles County Board of Supervisors. A part of Public Works' activities involve the planning, design, and construction of flood control and water conservation facilities, and the operation and maintenance of dams, debris basins, spreading grounds, channels, and storm drains.

PRECIPITATION

Public Works operates and maintains a network of 244 standard and automatic rain gages to collect rainfall (precipitation) data for the purposes of in-house engineering and design of flood control and water conservation facilities

RAINFALL AMOUNTS

[Daily](#) and [annual](#) rainfall amounts for the reporting period collected by Public Works' [active standard rain gages](#) are published in this volume. Although Public Works operates and maintains both standard and automatic rain gages whose recording durations range from 5 minutes to 24 hours, only daily and annual amounts from standard rain gages are published herein. Additional data (e.g., intensities, automatic rain gage data, partial data) may be obtained by contacting the [custodian](#) of hydrologic records. Active rain gage stations whose records are incomplete are denoted accordingly and no data is published.

ALERT SYSTEM

Automated Local Evaluation in Real Time

Public Works operates and maintains a state-of-the-art ALERT computer system to monitor meteorological conditions in the County and Southern California in real time, i.e., as they occur. The system includes a network of field sensors that monitor and receive precipitation amounts including rainfall data from the Corps of Engineers' Los Angeles Telemetry System.

COOPERATION

The cooperation of observers in furnishing rainfall data to Public Works as a public service is appreciated. The efforts of the many agencies and individuals who have so freely cooperated with us in the collection of this data have resulted in the large number of complete records for the period covered by this report.

Data from 22 stations of Public Works' records are reported and published by the National Oceanic and Atmospheric Administration (NOAA)

CUSTODIAN

Unpublished information may be obtained by contacting:

County of Los Angeles
Department of Public Works
Water Resources Division
P.O. Box 1460
Alhambra, CA 91802-1460
(626) 458-6120

PRECIPITATION

RAINFALL INDICES

Using Selected Stations for the Period October 1, 2014 through September 30, 2015

Area	Percent of Area	Seasonal Normal (inches)	Total Precipitation (inches)	Percent of Seasonal Normal
A. Coastal Plain	14.10%	13.22	9.17	69%
B. San Fernando Valley	7.90%	17.30	11.42	66%
C. San Gabriel Valley	7.50%	17.16	10.99	64%
D. San Gabriel Mountains	13.40%	26.94	17.23	64%
E. Little Rock, Big Rock	4.50%	17.87	12.47	70%
F. Santa Monica Mountains	5.70%	20.12	12.76	63%
G. Santa Clara	18.90%	16.68	11.21	67%
H. Desert	28.00%	7.34	7.52	103%
County*	100.00%	15.29	10.84	71%
Los Angeles (Station No. 716) **		15.46	10.61	69%
Cogswell Dam (Station No. 334-B)**		33.73	21.85	65%

* Seasonal Normal and Total Precipitation to Date sections of this line are derived from Areal Weighted Average. ** Automatic gage.

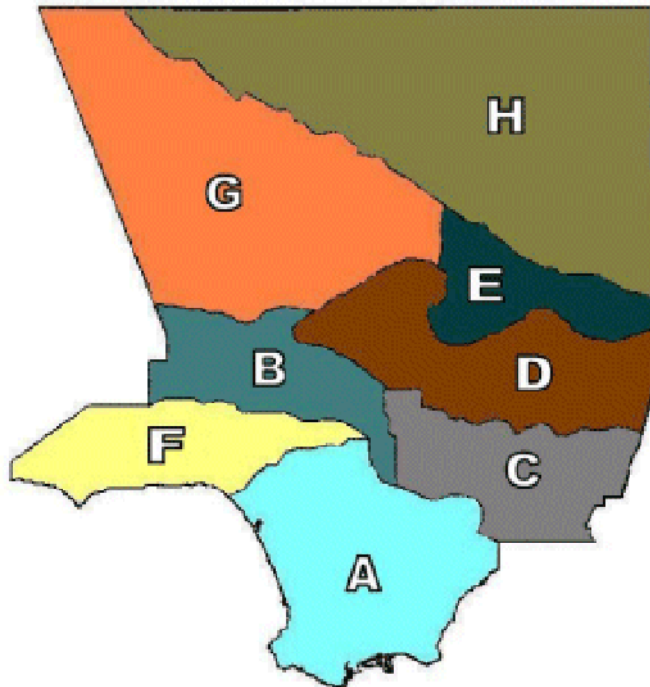

PRECIPITATION

Active Daily Rain Gage Stations During Water Year 2014 - 2015

Station ID	Station Name	Gage Type	Thomas Guide Page	North Latitude	West Longitude	Gage Elev. (ft)	Season Total (in)	Notes
13C	North Hollywood-Lakeside	S	563 B5	34-08-46	118-21-13	550	12.08	
21B	Woodland Hills	S	560 A2	34-10-14	118-35-33	875	9.18	E
33A	Pacoima Dam	SA	4642 F7	34-19-48	118-23-59	1500	11.12	
42C	Redondo Beach-City Hall	S	762 G5	33-50-43	118-23-20	70	9.61	
43D	Palos Verdes Estates	S	792 H4	33-47-58	118-23-29	216	11.05	
46D	Big Tujunga Dam	SA	4725 C6	34-17-40	118-11-14	2315	16.09	
63C	Santa Anita Dam	SA	537 E2	34-11-03	118-01-12	1400	17.41	
82F	Table Mountain	S	4561 G6	34-22-56	117-40-39	7420	17.04	A
89B	San Dimas Dam	SA	570 F2	34-09-10	117-46-17	1350	13.96	A
93C	Claremont-Police Station	S	601 C3	34-05-45	117-43-18	1170	13.35	
96C	Puddingstone Dam	SA	600 B4	34-05-31	117-48-24	1030	11.30	
106F	Whittier City Yard	S	677 B5	33-58-57	118-02-50	300	8.31	E
109D	West Arcadia	S	566 G7	34-07-42	118-04-22	547	11.00	
125B	San Francisquito Canyon Ph#1 - Saugus	S	X	34-35-25	118-27-15	2105	11.17	
134C	Puddingstone Diversion	SA	570 F5	34-07-52	117-46-55	1160	11.80	A
144	Sierra Madre Dam	S	537 B4	34-10-34	118-02-32	1100	15.26	
167C	Arcadia Pumping Plant #1	S	567 D2	34-09-31	118-02-02	611	12.08	A
169	Sierra Madre Pumping Plant	S	567 B2	34-09-47	118-02-21	700	13.77	
170F	Potrero Heights	SP	636 H5	34-02-32	118-04-44	285	10.17	
175B	La Canada Irrigation District	S	535 A1	34-13-39	118-12-40	2020	16.56	
176	Altadena-Rubio Canyon	S	536 A1	34-10-55	118-08-15	1125	14.40	
196C	La Verne-Fire Station	S	600 G2	34-06-06	117-46-20	1050	11.28	E
216C	Glendale - Jackson	SP	564 F5	34-09-54	118-15-01	615	10.98	
223C	Big Dalton Dam	SA	570 B1	34-10-06	117-48-36	1587	15.07	
225	Montana Ranch-Lakewood	S	766 C4	33-50-35	118-07-09	47	10.12	
228C	Beverly Hills City Hall	S	632 G1	34-06-00	118-23-40	245	9.00	E
235C	Henniger Flats	S	536 F5	34-11-38	118-05-17	2550	17.87	
251C	La Crescenta	S	534 F1	34-13-20	118-14-40	1440	14.28	A
252C	Castaic Lake	S	4369	34-29-53	118-36-53	1150	9.97	
287B	Glendora-City Hall	S	569 E5	34-08-09	117-51-52	785	14.44	A
294B	Sierra Madre-Mira Monte Pumping Plant	S	567 A1	34-10-11	118-02-51	985	14.56	
306H	Zuma Beach	S	667 B1	34-01-15	118-49-42	15	9.56	E
322	Munz Valley Ranch	SP	4013 A4	34-42-50	118-21-15	2600	8.55	
334B	Cogswell Dam	SA	XI	34-14-37	117-57-35	2300	24.24	
338C	Mt. Wilson-Observatory	S	571 G6	34-14-07	118-04-28	5709	29.26	

LEGEND

S Standard Gage
 SP Standard Private
 DA Daily Automatic
 A Automatic Recording Gage

NOTES:

E Estimate
 A Accumulated Total

PRECIPITATION

Active Daily Rain Gage Stations During Water Year 2014 - 2015

Station ID	Station Name	Gage Type	Thomas Guide Page	North Latitude	West Longitude	Gage Elev. (ft)	Season Total (in)	Notes
372	San Francisquito Power House No.2	SA	X	34-32-02	118-31-27	1580	12.37	
373C	Briggs Terrace	SP	504 H6	34-14-17	118-13-27	2200	17.66	
387B	Covina City Yard	S	599 B5	34-05-02	117-53-57	508	9.79	E
390B	Morris Dam	SA	539 C6	34-10-53	117-52-43	1210	15.09	
405B	Soledad Canyon	SP	4463 J6	34-26-23	118-17-33	2150	9.10	A
406C	West Azusa	S	598 H2	34-06-53	117-54-56	505	11.86	A
409B	Pyramid Reservoir	S	X	34-40-34	118-46-47	2505	11.86	
425B	San Gabriel Dam	SA	509 E3	34-12-19	117-51-38	1481	17.23	
436C	Hansen Dam	S	502 G3	34-16-08	118-23-59	1110	9.94	
445B	Live Oak Dam	SA	570 J5	34-08-02	117-44-38	1510	9.74	
449B	Eaton Wash Dam	SA	566 E1	34-10-06	118-05-33	880	12.26	A
453D	Devil's Gate Dam	SA	535 E7	34-10-53	118-10-27	980	15.92	A
455B	Lancaster-State Hwy Maintenance Sta.	S	4105 J1	34-40-57	118-08-02	2395	7.36	A
465C	Sepulveda Dam	S	561 G2	34-10-06	118-28-11	683	12.36	
482	Los Angeles-U.S.C.	S	674 A1	34-01-14	118-17-15	208	11.24	
497	Claremont-Slaughter	SP	571 B7	34-07-35	117-43-55	1350	12.46	
542	Fairmont	S	X	34-42-15	118-25-40	3050	11.15	
591B	Santa Anita Reservoir	S	536 E7	34-11-08	118-06-16	1205	14.96	E
598D	Neenach-Check 43-California D.W.R.	S	X	34-47-40	118-37-15	2965	9.00	
610B	Pasadena-City Hall	DA	565 J4	34-08-54	118-08-36	864	17.36	E
612B	Pasadena-Chlorine Plant	S	535 F3	34-12-04	118-09-49	1160	13.59	E
613C	Pasadena Fire Station	S	566 A6	34-07-15	118-08-05	779	12.05	A
626	Thompson Creek Dam Precipitation	SA	571 D4-E4	34-08-26	117-42-39	1670	12.66	E
627	San Gabriel Canyon-Power House	SA	568 J3	34-09-20	117-54-28	744	13.74	
662D	Long Beach Airport	S	791 J1	33-49-00	118-09-00	34	9.35	
680B	Westwood (U.C.L.A.)	S	632 B1	34-04-10	118-26-30	430	12.00	
716	Los Angeles-Ducommun St.	SA	634 H4	34-03-09	118-14-13	306	10.77	E
734C	Los Angeles International Airport	S	702 G5	33-56-25	118-23-44	105	9.42	
747	Sandberg-Airways Station	SA	X	34-44-47	118-43-29	4517	9.47	
749B	Burbank Valley Pump Plant	S	533 C6	34-11-11	118-20-54	655	11.49	
750B	Palmdale-F.A.A. Airport	S	4196 E5	34-37-20	118-05-00	2528	6.14	E
795	Pasadena-Jourdan	S	566 F5	34-08-52	118-05-14	705	11.16	E
1037	Arcadia-Arboretum	S	567 A5	34-08-48	118-02-59	565	12.45	A
1041B	Santa Fe Dam	S	598 A	34-07-04	117-58-24	427	12.05	
1051B	Canoga Park-Pierce College	S	530 D	34-10-51	118-34-23	800	9.43	

LEGEND

S Standard Gage
 SP Standard Private
 DA Daily Automatic
 A Automatic Recording Gage

NOTES:

E Estimate
 A Accumulated Total

PRECIPITATION

Active Daily Rain Gage Stations During Water Year 2014 - 2015

Station ID	Station Name	Gage Type	Thomas Guide Page	North Latitude	West Longitude	Gage Elev. (ft)	Season Total (in)	Notes
1058B	Palmdale	S	4196	34-35-17	118-05-31	2595	7.05	
1081B	Glendale-Gregg	SP	534 F	34-11-45	118-14-30	1350	12.71	
1088B	La Habra Heights-Mutual Water Co.	SA	708 D	33-56-55	117-57-51	445	9.42	A
1095	Orange County Reservoir	S	OC 2 F	33-56-07	117-52-58	660	11.29	
1114B	Whittier Narrows Dam	S	636 H	34-01-29	118-05-02	239	9.26	A
1115	San Antonio Dam	S	571 J	34-09-24	117-40-20	2120	12.66	
1158	Torrance Municipal Airport	S	793 E	33-47-59	118-20-08	102	10.58	
1212	Lancaster FSS/FAA	S	4014	34-44-00	118-13-00	2340	7.63	
1217	Los Angeles Country Club	S	632 D	34-04-10	118-25-17	380	12.07	
1222	Northridge-Garland	SP	501 C	34-14-17	118-30-59	911	10.90	
1240	Pearblossom-Calif.D.W.R. Booster Sta.	S	4378	34-30-32	117-55-15	3050	5.63	
1252	Palos Verdes Landfill	S	793 D	33-45-40	118-20-03	400	11.83	A
1253	Carson-County Sanitation	S	794 C	33-48-07	118-16-58	40	8.77	A
1254	Long Beach Reclamation Plant	S	796 G	33-48-11	118-05-20	20	9.53	E
1255	Los Coyotes Reclamation Plant	S	736 E	33-53-05	118-06-24	70	9.41	E
1256	South Gate Transfer Station	S	705 G	33-56-40	118-09-56	100	10.72	A
1257	San Jose Creek Reclamation Plant	S	637 F	34-01-55	118-01-16	275	9.64	E
1258	Puente Hills Landfill	S	637 D	34-01-35	118-01-49	300	11.19	A
1259	Whittier Narrows Reclamation Plant	S	636 J	34-03-59	118-03-54	225	9.28	E
1260	Spadra Landfill	S	640 A	34-02-36	117-49-50	700	10.49	A
1261	La Canada Reclamation Plant	S	535 D	34-13-00	118-11-14	1800	14.11	E
1262	Saugus Reclamation Plant	S	4550	34-24-48	118-32-23	1150	11.81	E
1263	Valencia Reclamation Plant	S	4549	34-25-55	118-37-13	1000	11.03	E
1264	Calabajas Landfill	S	558 G	34-08-25	118-42-35	800	11.15	A
1265	Scholl Canyon Landfill	S	565 C	34-08-38	118-11-07	1000	12.17	A
1266	Mission Canyon Landfill	S	591 G	34-08-40	118-28-45	1150	13.86	A
1267	Lancaster Reclamation Plant	S	3925	34-46-38	118-09-11	2302	4.76	E
1268	Palmdale Reclamation Plant	S	4196	34-35-30	118-05-10	2565	5.56	E
1271	Pomona Waste Reclamation Plant	S	640 E	34-03-18	117-47-34	786	11.57	E
1274	Whittier - Valna Drive	SP	707 F	33-57-39	118-01-10	255	9.79	
1290	Woodland Hills	SP	559 J1	34-10-39	118-36-45	873	9.58	

LEGEND

S Standard Gage
 SP Standard Private
 DA Daily Automatic
 A Automatic Recording Gage

NOTES:

E Estimate
 A Accumulated Total

PRECIPITATION

DAILY RAINFALL SUMMARY



(See Appendix A)

PRECIPITATION

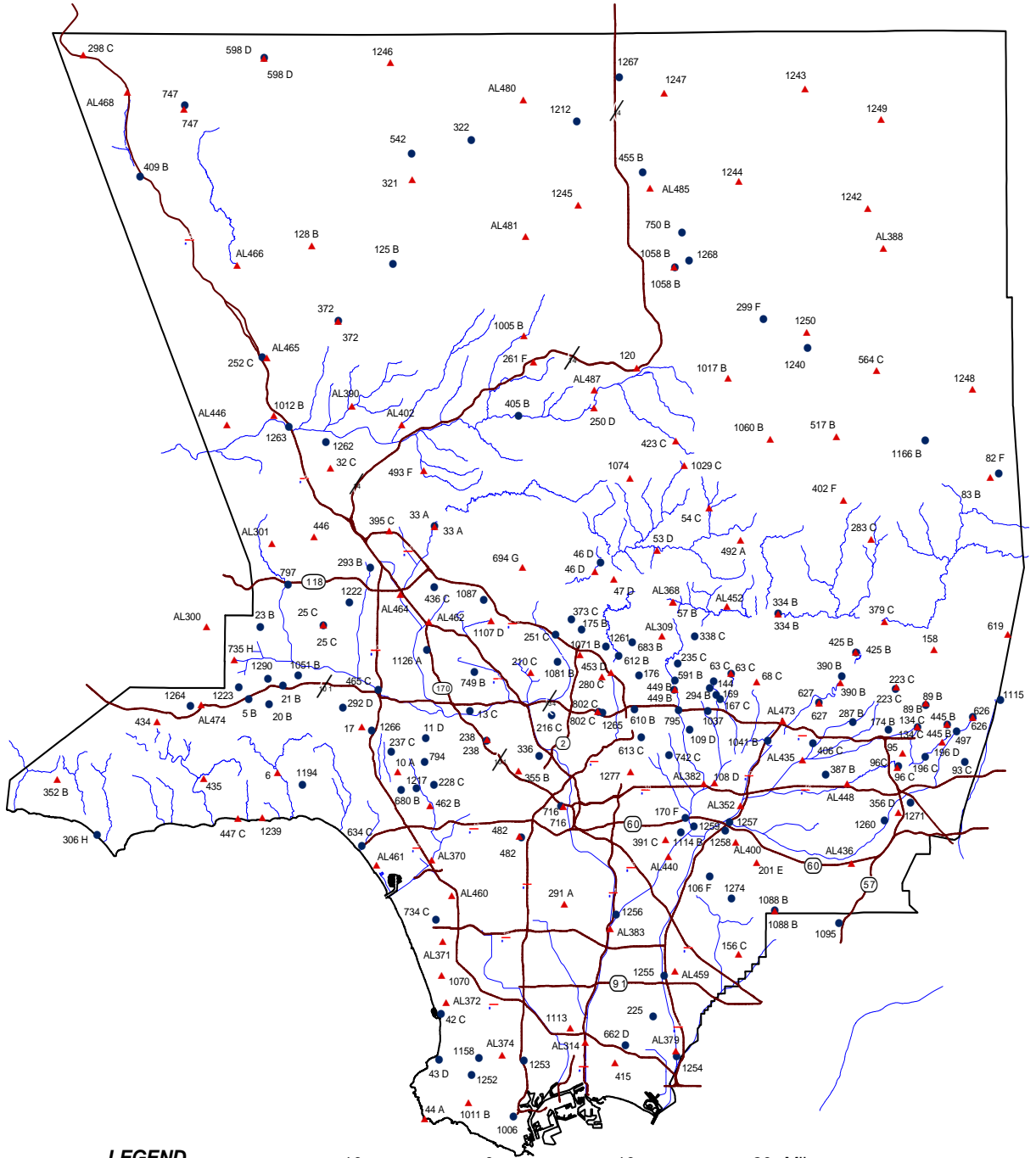
Rain Gage Locations



LEGEND

-  ALERT RAIN GAGE
-  STANDARD RAIN GAGE

10 0 10 20 Miles

SCALE



EVAPORATION

Public Works, the Metropolitan Water District, Palmdale Water District, the California Dept. of Water Resources, and Descanso Gardens provided daily evaporation data for 13 evaporation stations during the reporting period. [Monthly and Seasonal](#) summaries are provided in the report. Daily records of active and inactive stations are available in Public Works' files, along with some data for other agencies and districts. This data can be obtained by contacting the [custodian](#) of hydrologic records.

LENGTH OF RECORD

The Los Angeles County Flood Control District (now administered by Public Works) installed its first evaporation pan in March 1929 at Santa Anita Dam. Public Works has data for 37 evaporation stations which have monthly evaporation for more than 15 seasons.

CUSTODIAN

Unpublished information may be obtained by contacting:

County of Los Angeles
Department of Public Works
Water Resources Division
P.O. Box 1460
Alhambra, CA 91802-1460
(626) 458-6120

ACTIVE STATIONS

ID	Station Name	Equipment	Pan Elev.	Thomas Guide	North Latitude	West Longitude
33-A	Pacoima Dam	24X36 S	1500 ft.	482 F1	34-19-48	118-23-59
46-D	Big Tujunga Dam	24X36 S	2315 ft.	4725 C5	34-17-40	118-11-14
63-C	Santa Anita Dam	24X36 S	1400 ft.	537 E6	34-11-03	118-01-12
89-B	San Dimas Dam	24X36 S	1350 ft.	570 F3	34-09-10	117-46-17
96-C	Puddingstone Dam	24X36 S	1030 ft.	600 B4	34-05-31	117-48-24
223-B	Big Dalton Dam	24X36 S	1587 ft.	570 B1	34-10-06	117-48-36
252-C	Castaic Reservoir	48X10 S	1150 ft.	4369 H6	34-29-53	118-36-53
334-B	Cogswell Dam	24X36 S	2300 ft.	508 B5	34-14-37	117-57-35
390-B	Morris Dam	72X36 US	1210 ft.	539 C7	34-10-53	117-52-43
409-B	Pyramid Reservoir	48X10 S	2505 ft.	593 E1	34-40-34	118-46-47
425-B	San Gabriel Dam	24X36 S	1481 ft.	539 E3	34-12-19	117-51-38
1058-B	Palmdale	24X36 S	2595 ft.	4196 D6	34-35-17	118-05-31
1240	Pearblossom	24X36 S	3030 ft.	4378 F3	34-30-32	117-55-15

FOOTNOTES

24X36 S Screened land pan, 24 inches in diameter by 36 inches deep.

48X10 S Screened land pan, 48 inches in diameter by 10 inches deep.

72X36 US Unscreened land pan, 72 inches in diameter by 36 inches deep.

EVAPORATION

MONTHLY SUMMARY

ID	Station Name	Oct	Nov	Dec	Jan	Feb	Mar	Apr	May	Jun	Jul	Aug	Sep	Total
33-A	Pacoima Dam	9.88	8.72	4.96	6.7	6.31	9.54	9.14	5.71	8.34	8.4	11.18	10.56	99.43
46-D	Big Tujunga Dam	9.21	5.89	2.64	3.69	4.11	6.35	7.32	6.32	[10.00]	9.76	11.46	8.89	[85.64]
63-C	Santa Anita Dam	6.14	5.07	2.41	3.14	3.47	5.14	5.15	3.22	4.73	5.07	6.92	6	56.46
89-B	San Dimas Dam	[]	[0.90]	[0.75]	[2.13]	[1.80]	[2.54]	[4.16]	[3.86]	[2.22]	[]	[]	[]	[18.38]
96-C	Puddingstone Dam	5.08	3.15	1.06	1.53	2.02	4.09	5.32	4.55	6.05	6.75	7.67	6.2	53.48
223-C	Big Dalton Dam	5.51	3.28	1.47	1.74	2.31	4.24	5.44	4.53	6.47	7.02	8.38	6.96	57.33
252-C*	Castaic Dam	6.53	4.15	[2.30]	[2.01]	2.27	4.96	5.81	5.21	8.09	8.36	[]	16.02	[65.71]
334-B	Cogswell Dam	5.28	3.18	0.68	1.48	2.23	6.9	5.55	4.64	6.97	6.68	7.28	4.93	55.79
390-B	Morris Dam	7.9	5.17	3.65	3.55	4.12	7.61	7.69	6.24	9.06	9.62	10.92	9.26	84.79
409-B*	Pyramid Reservoir	8.2	5.19	[4.04]	[2.49]	2.86	4.6	5.12	5.99	10.07	9.56	[]	[]	[58.12]
425-B	San Gabriel Dam	8.27	5.61	2.95	3.51	4.08	6.53	6.7	5.47	7.64	8.5	9.7	8.75	77.71
1058-B	Palmdale	[6.00]	[3.46]	[1.35]	[1.56]	[2.33]	4.9	6.44	9.42	12.15	10.16	11.95	7.55	[77.25]
1240*	Pearblossom	9.89	[6.07]	[]	[2.81]	[]	[]	[]	[]	[]	[]	[]	12.49A	[31.26A]

Units are in inches.

[] Records Incomplete.

* Department of Water Resources.

EVAPORATION

Evaporation Station Locations

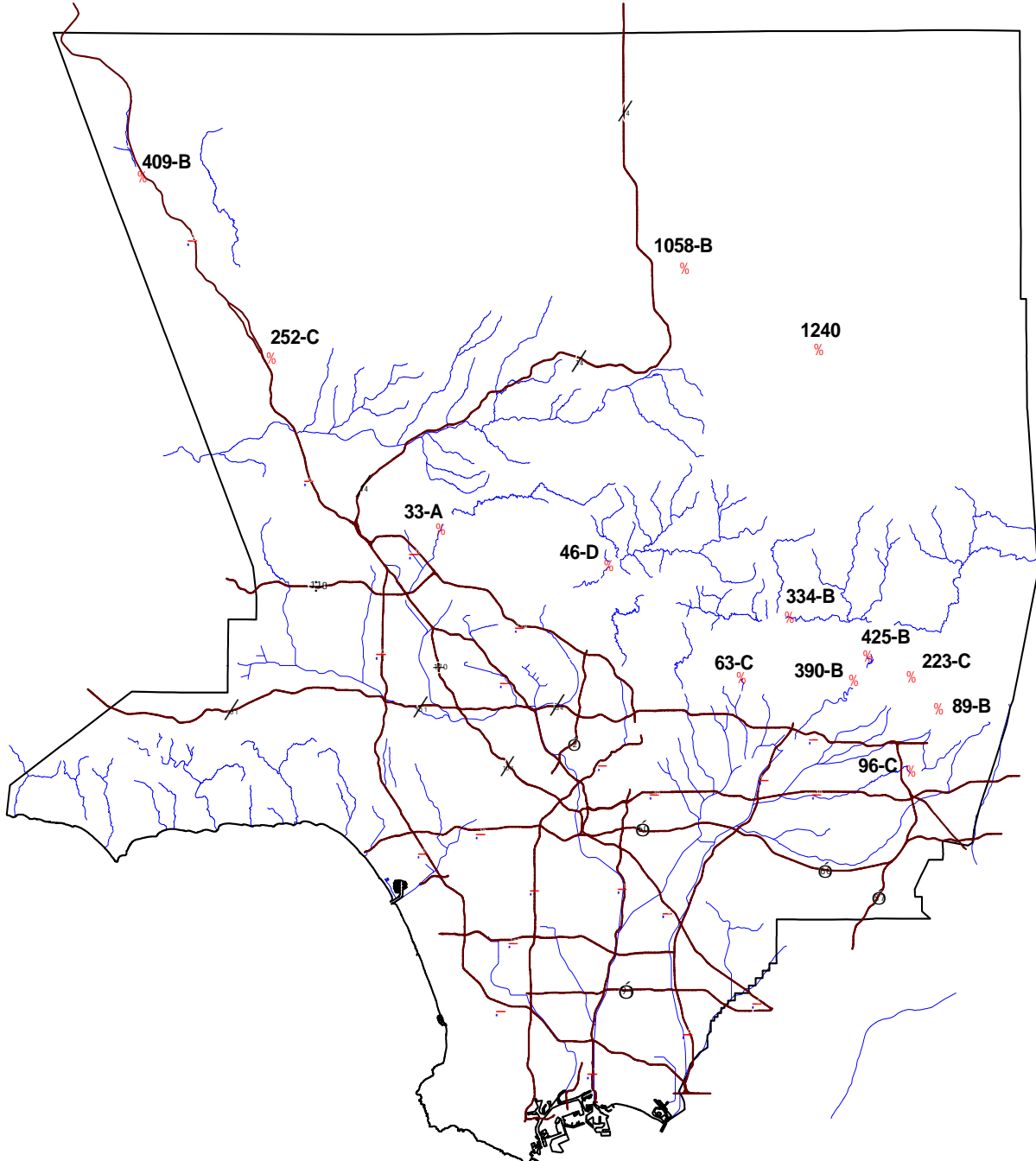

LEGEND

■ Evaporation Station

10 0 10 20 Miles

SCALE



RUNOFF

Public Works operated 62 stream gaging [stations](#) during the 2014-15 water year. [Mean daily flow](#) and maximum instantaneous flow rates for each station are summarized and published in this volume. [Annual summaries](#) of peak flows and volumes are also provided. Additional data can be obtained by contacting the [custodian](#) of hydrologic records.

LEGEND

Stations are designated by letters and numbers which indicate ownership, operation agency, and type of station.

- Prefix **F** - Indicates a station originally owned and operated by the Los Angeles County Flood Control District and now owned and operated by Public Works.
- Prefix **E** - Indicates a station owned by the U.S. Army Corps of Engineers, but operated and maintained by the U.S. Geological Survey.
- Prefix **U** or **G** - Indicates a station originally constructed and operated by the U.S. Geological Survey, but now operated by Public Works.
- Prefix **L** - Indicates a station formerly owned by the Little Rock Water District, but now owned and operated by Public Works.
- Suffix **R** - Indicates a recorder station.
- Suffix **B, C** - Indicates that the station has been moved from its original location. B represents second location, C a third location, etc.

ALERT SYSTEM

Automated Local Evaluation in Real Time

Public Works operates and maintains the ALERT computer system to monitor meteorological conditions at 24 river stage locations in the County. Public Works' ALERT System also receives rainfall, streamflow, and reservoir data from the Corps of Engineers' Los Angeles Telemetry System.

COOPERATION

Public Works receives or has access to stream flow data from other agencies. Public Works exchanges data with the following agencies:

- U.S. Geological Survey, Water Resource Division
- U.S. Army Corps of Engineers
- State Department of Water Resources
- The Metropolitan Water District of Southern California
- San Gabriel River Water Committee

CUSTODIAN

Unpublished information may be obtained by contacting:

County of Los Angeles
Department of Public Works
Water Resources Division
P.O. Box 1460 Alhambra, CA 91802-1460
(626) 458-6120

RUNOFF

Index of Stream Gaging Stations

Station ID	Station Name	Thomas Guide Page	Regulated	Drainage Area Sq.Mile	Length Of Record
F81D-R	ALHAMBRA WASH above Klingerman Street	636 G3	No	15.2	09/02/1936
F317-R	ARCADIA WASH below Grand Avenue	597 C4	Yes	8.5	12/12/1955
F277-R	ARROYO SECO below Devils Gate Dam	535 E7	Yes	32.5	11/30/1942
F38C-R	BALLONA CREEK above Sawtelle Blvd.	672 G4	Yes	88.6	08/10/1967
F120B-R	BIG DALTON CREEK below Big Dalton Dam	509/540	Yes	4.8	06/03/1940
F394-R	BIG ROCK CREEK upstream from Pallett Creek	4469 D3	No	34.3	10/01/1986
F168B-R	BIG TUJUNGA CREEK below Big Tujunga Dam	4645/4725	Yes	82.3	12/08/1931
F377B-R	BOUQUET CREEK above Bouquet Canyon Road	4461 C5	Yes	60.9	10/01/2003
F329-R	BRADBURY CHANNEL below Central Avenue	568 C5	Yes	3.3	06/14/1957
F342-R	BRANFORD STREET CHANNEL below Sharp Avenue	502 E7	Yes	5.01	01/12/1962
E285-R	BURBANK WESTERN STORM DRAIN at Riverside Dr.	563 H3	Yes	25	10/01/1949
F37B-R	COMPTON CREEK near Greenleaf Drive	734 J6	No	22.6	10/03/1938
F354-R	COYOTE CREEK below Spring Street	796 H2	Yes	185	12/17/1963
F274B-R	DALTON WASH at Merced Avenue	638 D1	Yes	35.95	11/02/1958
F318-R	EATON WASH at Loftus Drive	597 A7	Yes	22.8	02/23/1956
F271-R	EATON WASH below Eaton Wash Dam	566 F1	Yes	12.4	10/01/1940
U7-R	FISH CREEK above mouth of canyon	568 G1	No	6.36	07/01/2017
L1-R	LITTLE ROCK CREEK above Little Rock Dam	4467 D2	No	49.2	10/01/1930
F356-R	LIVE OAK CREEK below Live Oak Dam	571 A5	Yes	2.28	11/29/1963
F319-R	LOS ANGELES RIVER below Wardlow River Road	765 C1	Yes	815	01/13/1956
F34D-R	LOS ANGELES RIVER below Firestone Blvd.	705 F4	Yes	596	11/12/1956
F300-R	LOS ANGELES RIVER at Tujunga Avenue	562 J6	Yes	401	05/08/1950
F57C-R	LOS ANGELES RIVER above Arroyo Seco	594 H6	Yes	511	12/08/1983
F130-R	MALIBU CREEK below Cold Creek	628 H1	Yes	104.96	01/17/1931
F395-R	MESCAL CREEK at mouth of canyon	4471 D4	Yes	5.41	01/28/1983
F328B-R	MINT CANYON CREEK at Sierra Highway	4462 C6	No	28	10/01/2003
F181-R	MONTEBELLO STORM DRAIN above Rio Hondo	676 E4	No	9.6	01/12/1932
F118C-R	PACOIMA CREEK FLUME below Pacoima Dam	4642 F7	Yes	28.2	02/09/1935
F305-R	PACOIMA DIVERSION at Branford Street	502 D7	Yes	48.8	10/30/1953
F122-R	PALLETT CREEK at Valyermo Highway	4469 D2	No	15.8	10/31/1961
F45B-R	RIO HONDO above Stuart and Gray Road	705 G4	Yes	140	11/20/1951
F192B-R	RIO HONDO below Lower Azusa Avenue	597 D5	Yes	40.9	12/18/1958
F313B-R	RIO HONDO BYPASS - Zone 1 Ditch	637 A7	Yes	Controlled	11/28/1983
F338-R	RUBIO DIVERSION CHANNEL below Gooseberry Inlet	536 C5	Yes	2.1	12/16/1959
F82C-R	RUBIO WASH at Glendon Way	596 H7	Yes	10.9	11/06/1936
F303-R	SAN DIMAS CREEK below San Dimas Dam	570 F2	Yes	16.2	12/24/1951
F218-R	SAN DIMAS WASH below Puddingstone Diversion	570 E5	Yes	19.9	01/26/1933
F250-R	SAN GABRIEL - AZUSA Conduit 25 Ft. Weir Below S.G. Dam	509/539	Yes	202.7	02/14/1935

RUNOFF

Index of Stream Gaging Stations

Station ID	Station Name	Thomas Guide Page	Regulated	Drainage Area Sq.Mile	Length Of Record
F220B-R	SAN GABRIEL - AZUSA Conduit 10 Ft. Weir Below S.G. Dam	509/539	Yes	0	10/23/1963
F262C-R	SAN GABRIEL RIVER above Florence Avenue	706 E5	Yes	215.8	08/06/1968
F42B-R	SAN GABRIEL RIVER above Spring Street	796 G1	Yes	231	11/16/1964
F263C-R	SAN GABRIEL RIVER below San Gabriel River Pkwy	676 J2	Yes	206.3	08/09/1968
F190-R	SAN GABRIEL RIVER at Foothill Blvd.	568 E5	Yes	230	04/25/1932
E281-R	SAN GABRIEL RIVER below Santa Fe Dam	568 B2	Yes	239	02/09/1943
F209-R	SAN GABRIEL RIVER below Cogswell Dam	508 C5	Yes	41	12/08/1933
G44B-R	SAN GABRIEL RIVER above Whittier Narrows Dam	637 A7	Yes	442	01/06/1948
U8-R	SAN GABRIEL RIVER below Morris Dam	569 B2	Yes	212.4	05/18/1994
F251-R	SAN GABRIEL RIVER - West Fork at toe of Cogswell Dam	508 C5	Yes	39.2	04/26/1935
F312B-R	SAN JOSE CHANNEL above Workman Mill Road	637 G6	Yes	83.4	04/23/1992
F119C-R	SANTA ANITA CREEK Below Santa Anita Dam	537 E6	Yes	10.8	01/13/1964
F260C-R	SANTA ANITA WASH below Foothill Blvd.	567 D4	Yes	17.2	12/11/1959
F193B-R	SANTA ANITA WASH at Longden Avenue	597 F2	Yes	18.8	01/05/1960
F92C-R	SANTA CLARA RIVER at Old Road Bridge	4450 C2	Yes	410.4	09/01/1981
F93C-R	SANTA CLARA RIVER at Capra Road Railroad Crossing	4462 J7	No	157	02/08/2002
F280-R	SANTA FE DIVERSION CHANNEL below Santa Fe Dam	598 B2	Yes	Controlled	10/01/1942
F125-R	SANTIAGO CANYON CREEK above Little Rock Creek	4467 D2	No	11.2	09/29/1953
F278-R	SAWPIT CREEK below Sawpit Dam	537 H7	Yes	3.3	02/06/1942
F194B-R	SAWPIT WASH below Live Oak Avenue	597 G2	Yes	16.1	12/05/1960
F32-R	THOMPSON CREEK below Thompson Creek Dam	571 E4	Yes	3.7	10/01/1944
F54C-R	TOPANGA CREEK above mouth of canyon	630 C3	No	18	01/01/1930
F252-R	VERDUGO WASH at Estelle Avenue	564 C3	Yes	26.8	12/02/1935
F304-R	WALNUT CREEK above Puente Avenue	638 B1	Yes	57.6	10/14/1952
F40-R	WALNUT CREEK below Puddingstone Dam	600 B4	Yes	33.2	12/28/2027

RUNOFF

STREAM GAGING STATION INFORMATION

(See Appendix B)

DAILY DISCHARGE

(See Appendix C)

STREAM GAGING STATION PEAK FLOW

(See Appendix D)

RUNOFF

STREAM GAGE STATION LOCATIONS

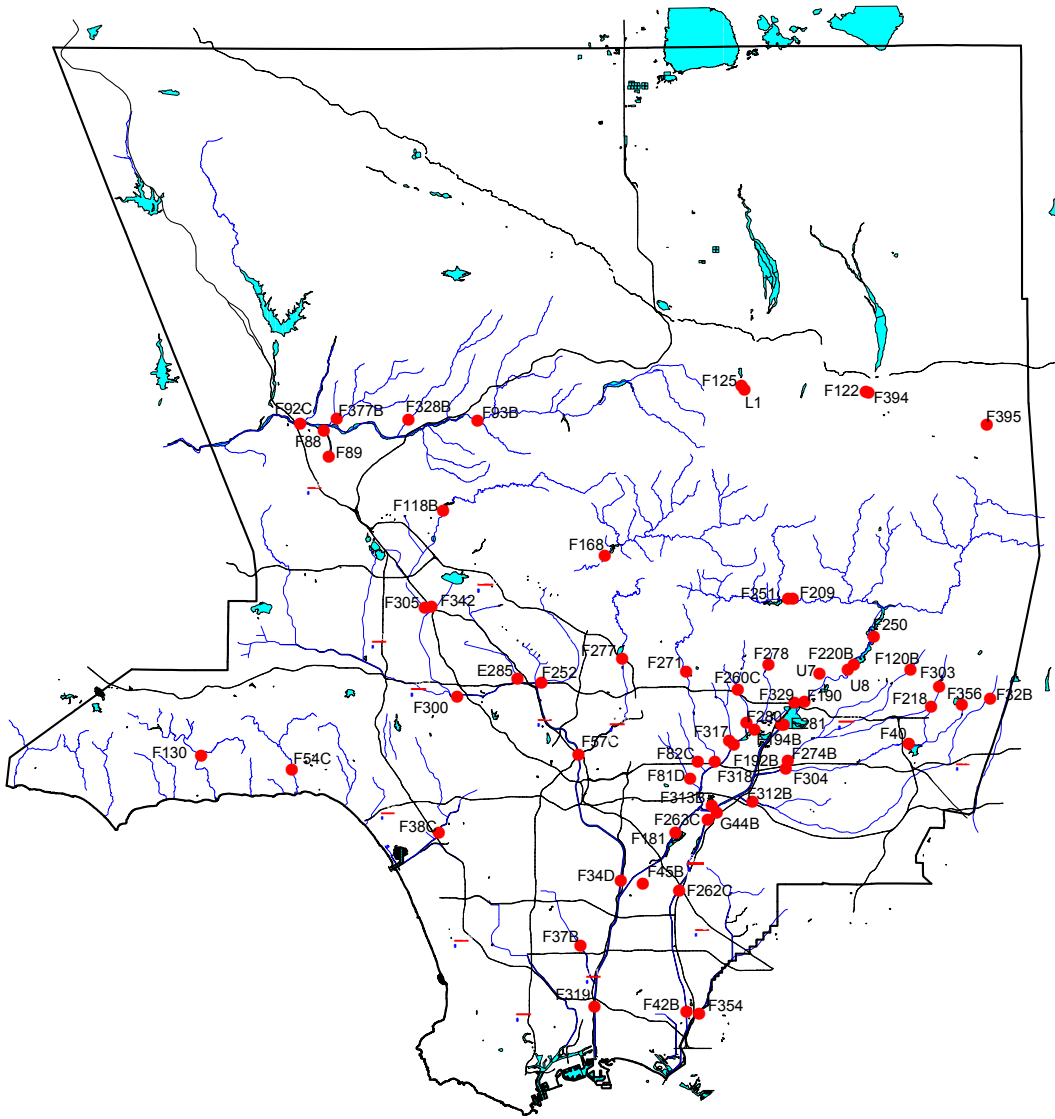

LEGEND

● Stream Gage Station



RESERVOIRS

RESERVOIRS

Following the damaging flood of 1914 and creation of the Los Angeles County Flood Control District in 1915, a program of flood control and water conservation was initiated by the District. Part of this program included the construction of 14 dams which were completed between 1920 and 1939. These dams continued to be operated and maintained by Public Works to control flood waters during storm periods. Public Works makes post storm releases, when feasible, in amounts that can be conserved in downstream spreading grounds and by channel percolation. In addition, five Corps of Engineers' dams - Lopez, Hansen, Santa Fe, Sepulveda, and Whittier Narrows Dams, are operated by the Corps in conjunction with Public Works' dams to achieve flood control and/or water conservation.

RECORDS:

Public Works' 14 dams and reservoirs' locations are shown on the [map](#). Data on the yearly reservoir operation summaries for each reservoir are provided by selecting from the Yearly Summary on the left. Data for these facilities can be obtained by contacting the custodian of hydrologic records.

Los Angeles County Department of Public Works
Water Resources Division
P.O. Box 1460
Alhambra, CA 91802-1460
(626) 458-6120

RESERVOIRS

YEARLY RESERVOIR OPERATION SUMMARY

(See Appendix E)

Location	Appendix E
Big Dalton Dam	Appendix E 01
Big Tujunga Dam	Appendix E 02
Cogswell Dam	Appendix E 03
Devil's Gate Dam	Appendix E 04
Eaton Wash Dam	Appendix E 05
Live Oak Dam	Appendix E 06
Morris Dam	Appendix E 07
Pacoima Dam	Appendix E 08
Puddingstone Dam	Appendix E 09
Puddingstone Diversion	Appendix E 10
San Dimas Dam	Appendix E 11
San Gabriel Dam	Appendix E 12
Santa Anita Dam	Appendix E 13
Thompson Creek Dam	Appendix E 14

RESERVOIRS

FACILITIES

DPW Dams and Reservoirs	Current Uses	Construction Completed	Drainage Area (sq.mi)	Original Capacity (acre-ft)	Spillway Elev. (ft)	Location
Big Dalton Dam	Flood control and water conservation	August 1929	4.5	1053	1706	4 miles northeast of Glendora
Big Tujunga Dam	Flood control and water conservation	July 1931	82.3	6240	2290	10 miles northeast of Sunland
Cogswell Dam	Flood control and water conservation	April 1934	39.2	12298	2385	22 miles north of Azusa
Devil's Gate Dam	Flood control and water conservation	June 1920	31.9	2479*	1067	Arroyo Seco, northwest of Pasadena
Eaton Wash Dam	Flood control and water conservation	February 1937	12.4	956	887.5	Eaton Wash, northeast of Pasadena
Live Oak Dam	Flood control and water conservation	November 1922	2.3	250	1496.4	2.5 miles northeast of La Verne
Morris Dam	Water conservation	1935	211.4	39300	1152	5 miles north of Azusa
Pacoima Dam	Flood control and water conservation	February 1929	28.2	6060	1950	4 miles northeast of San Fernando
Puddingstone Dam	Flood control and water conservation	January 1928	33.1	17398	970	1 mile south of San Dimas
Puddingstone Diversion	Flood control and water conservation	July 1928	19.9	148	1152.5	2 miles northeast of San Dimas
San Dimas Dam	Flood control and diversion of flow	September 1922	16.2	1496	1462	3 miles northeast of San Dimas
San Gabriel Dam	Flood control and water conservation	July 1939	202.7	53344	1453	7.5 miles north of Azusa
Santa Anita Dam	Flood control and water conservation	March 1927	10.8	1376	1316	2.5 miles north of Arcadia
Thompson Creek Dam	Flood control and water conservation	March 1928	3.5	812	1634	3 miles north of Claremont

Note: All dams listed above are under the jurisdiction of the Division of Safety of Dams (DSOD), under the California Department of Water Resources.

* Based on modification to Devil's Gate Dam spillway completed in 1998.

BIG DALTON DAM AND RESERVOIR

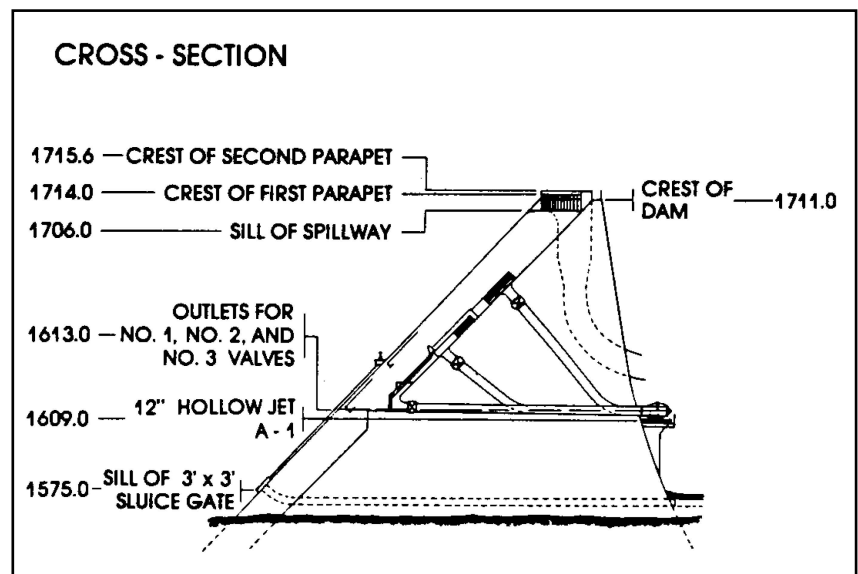
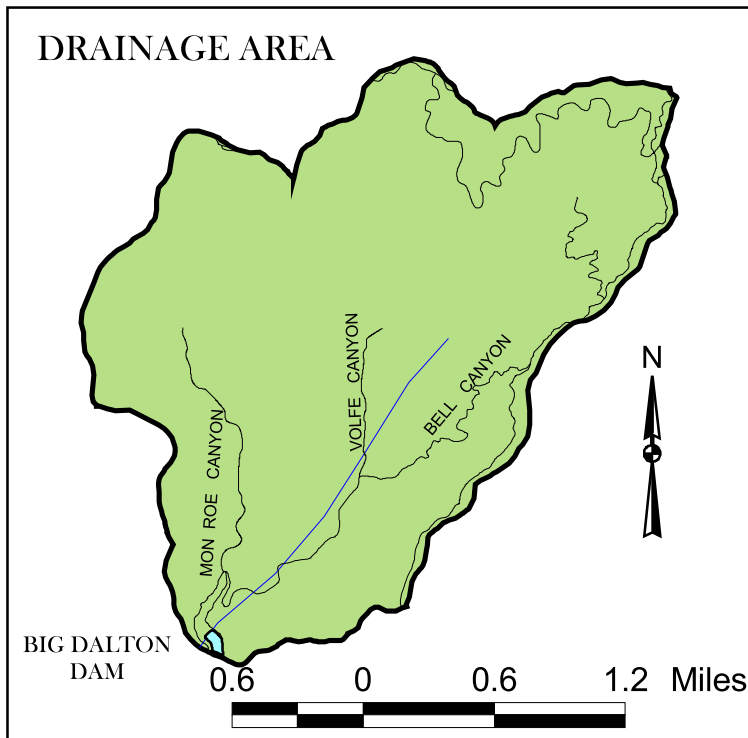

PURPOSE - Flood control and water conservation.

DATE CONSTRUCTED - Started December 1927. Completed August 1929.

LOCATION - Big Dalton Canyon, 4.0 miles northeast of Glendora.

DRAINAGE AREA - 4.5 square miles.

CAPACITY (As of latest survey date) - 1,075.3 acre - feet.

SURVEY DATE - August 2014.

SPILLWAY ELEVATION - 1,706 feet.

BIG TUJUNGA DAM AND RESERVOIR

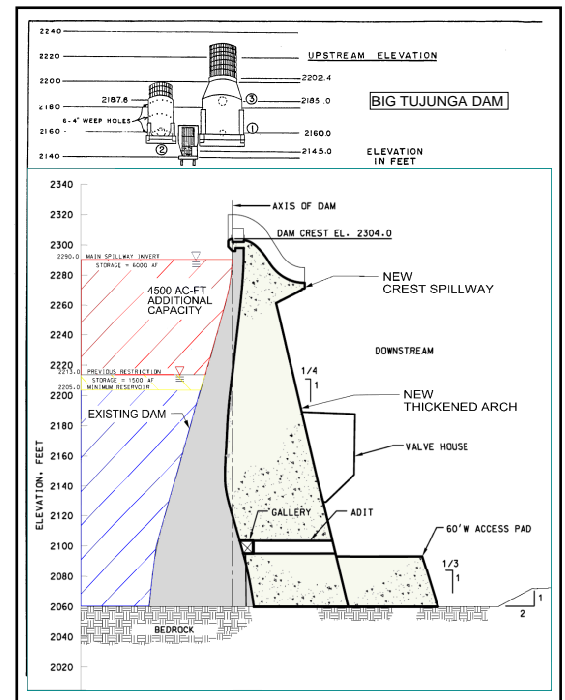
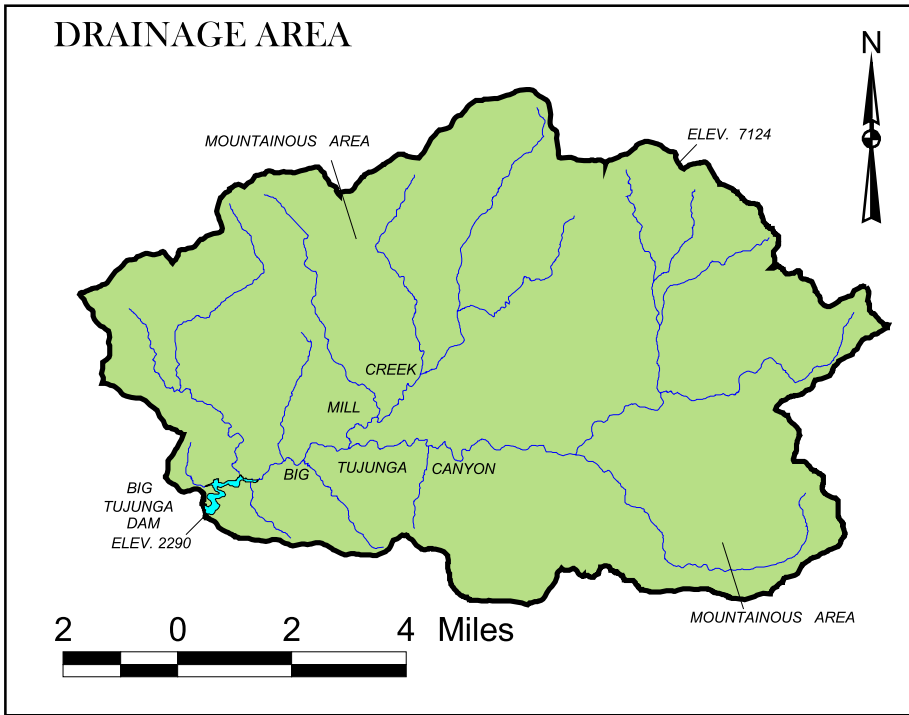

PURPOSE - Flood control and water conservation.

DATE CONSTRUCTED - Started January 1930. Completed July 1931.

LOCATION - Big Tujunga Canyon, 10.0 miles northeast of Sunland.

DRAINAGE AREA - 82.3 square miles.

CAPACITY (As of latest survey date) - 4,952 acre - feet.

SURVEY DATE - September 2015.

SPILLWAY ELEVATION - 2,290 feet.

COGSWELL DAM AND RESERVOIR

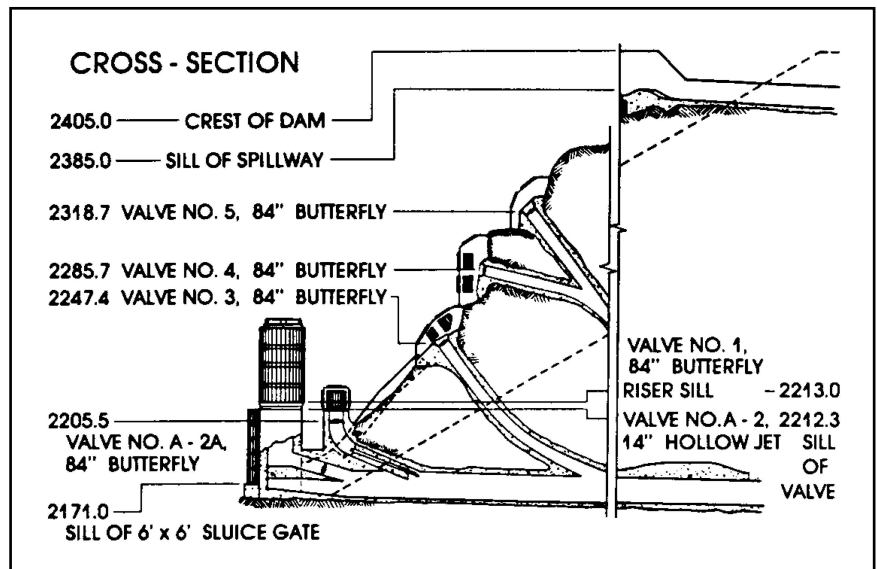
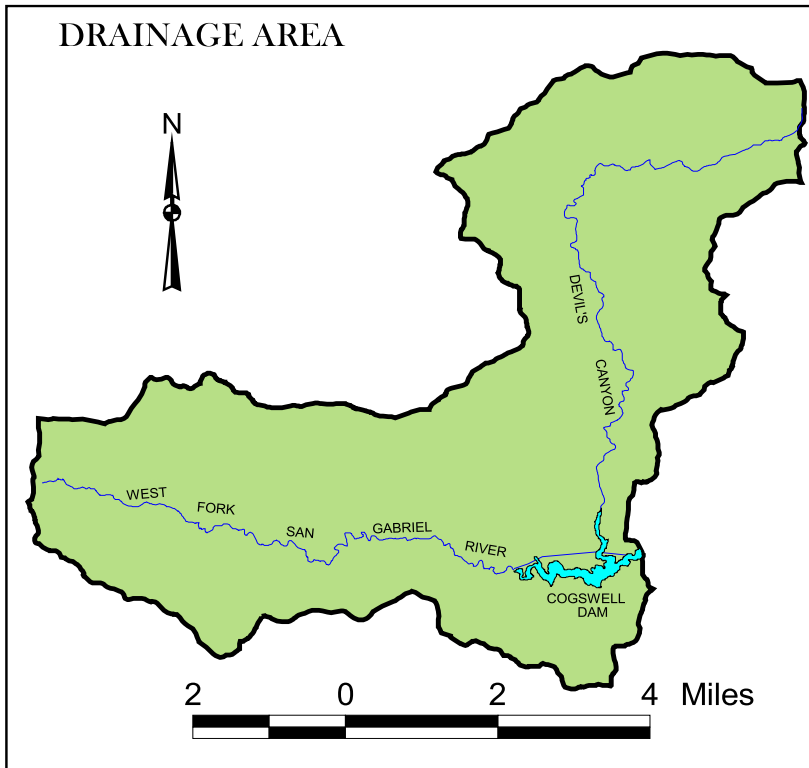

PURPOSE - Flood control, water conservation, and recreation.

DATE CONSTRUCTED - Started March 1932. Completed April 1934.

LOCATION - 22.0 miles northeast of Azusa.

DRAINAGE AREA - 39.2 square miles.

CAPACITY (As of latest survey date) - 10,508 acre - feet.

SURVEY DATE - October 2012.

SPILLWAY ELEVATION - 2,385 feet.

DEVIL'S GATE DAM AND RESERVOIR

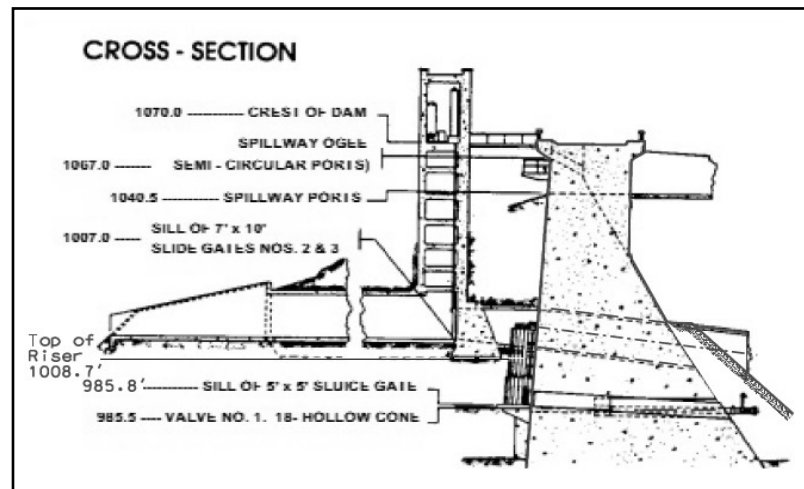
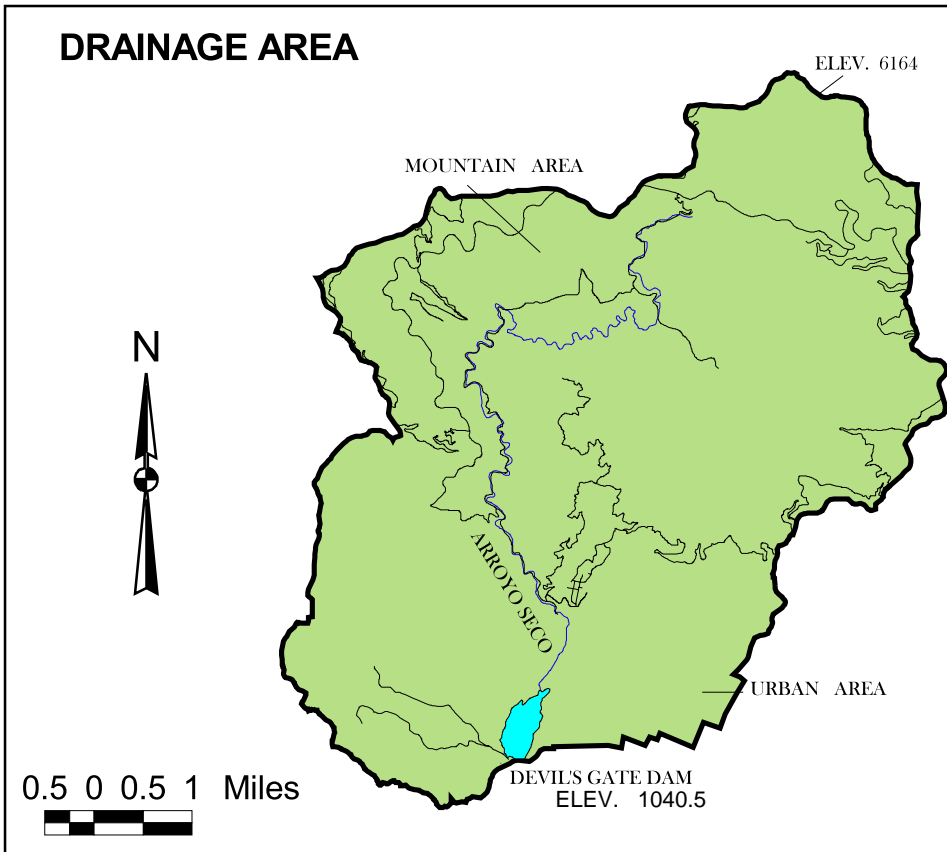

PURPOSE - Flood control and water conservation.

DATE CONSTRUCTED - Started May 1919. Completed June 1920.

LOCATION - On Arroyo Seco, northwest of Pasadena.

DRAINAGE AREA - 31.9 square miles.

CAPACITY (As of latest survey date) - 868 acre - feet.

SURVEY DATE - May 2014.

SPILLWAY ELEVATION - 1,067 feet.

EATON WASH DAM AND RESERVOIR

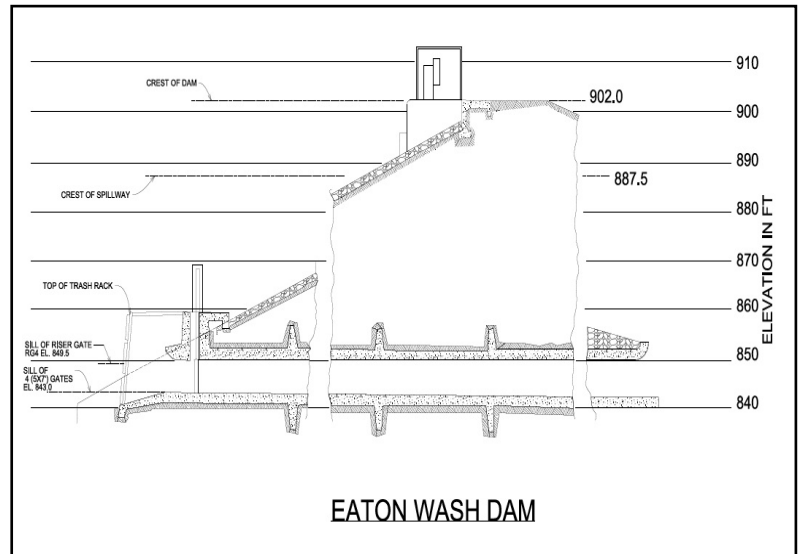
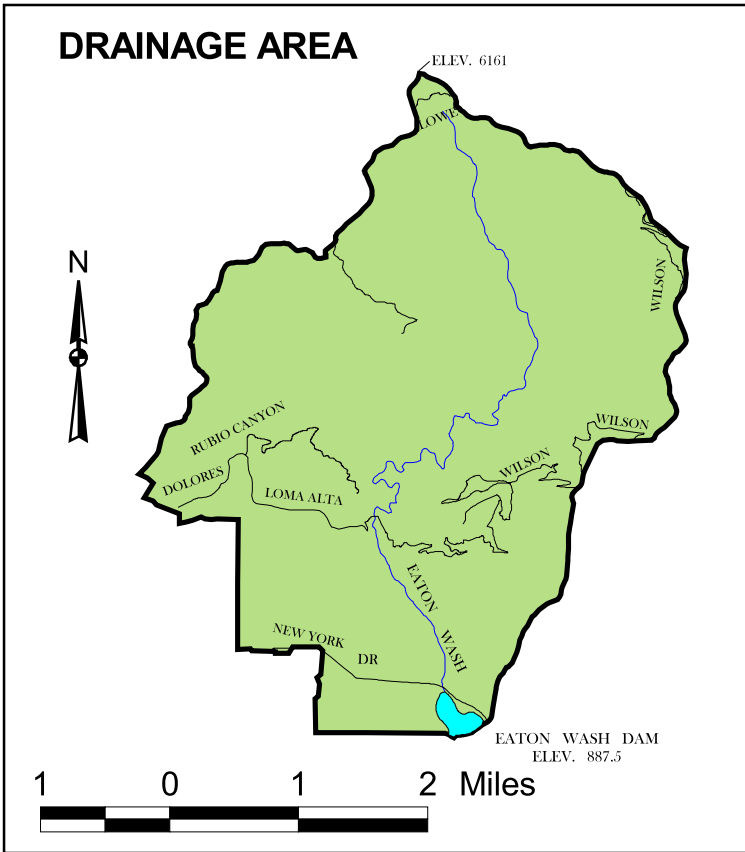

PURPOSE - Flood control and water conservation.

DATE CONSTRUCTED - Started January 1936, completed February 1937.

LOCATION - Eaton Wash, northeast of Pasadena.

DRAINAGE AREA - 12.4 square miles.

CAPACITY (As of latest survey date) - 652.3 acre - feet.

SURVEY DATE - August 2011.

LIVE OAK DAM AND RESERVOIR

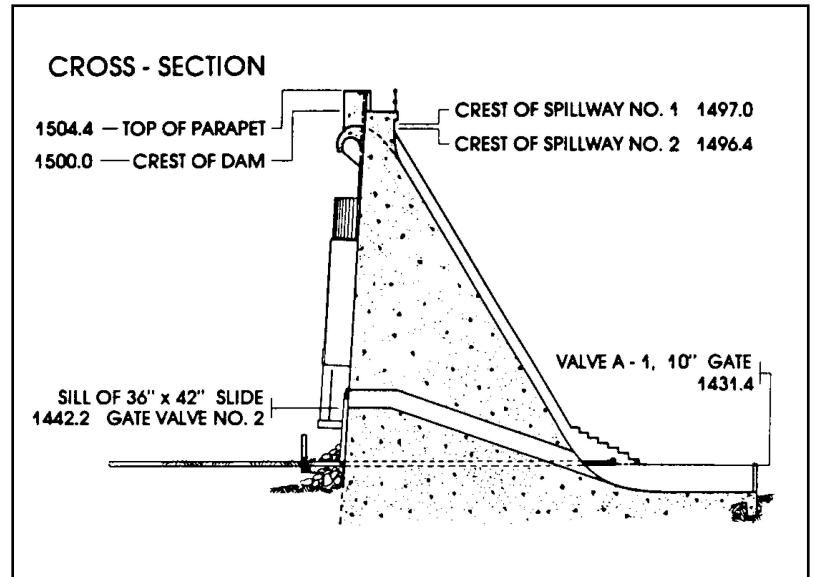
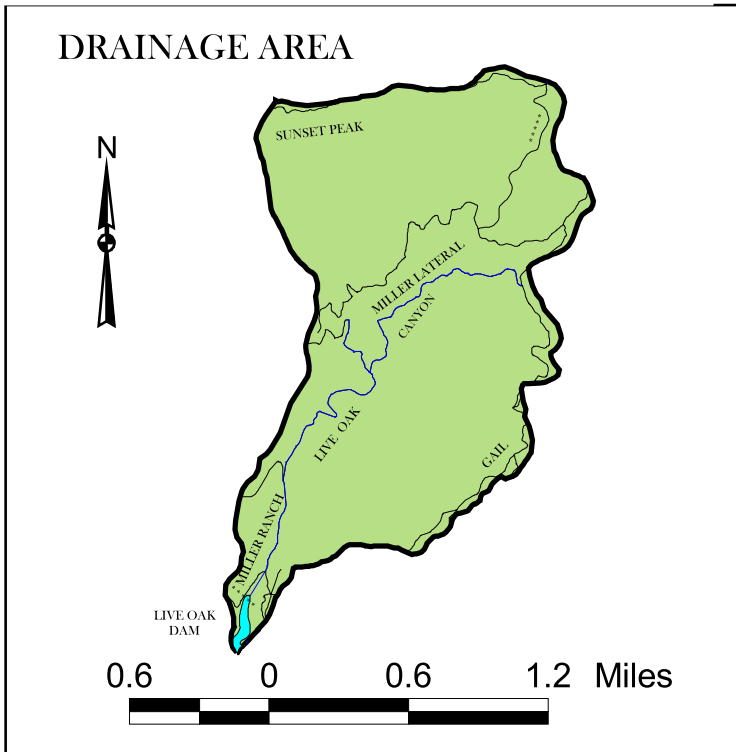

PURPOSE - Flood control and water conservation.

DATE CONSTRUCTED - Started August 1921, completed November 1922.

LOCATION - 2.5 miles northeast of La Verne.

DRAINAGE AREA - 2.3 square miles.

CAPACITY (As of latest survey date) - 235.8 acre - feet.

SURVEY DATE - August 2015.

SPILLWAY ELEVATION - 1496.4 feet.

MORRIS DAM AND RESERVOIR

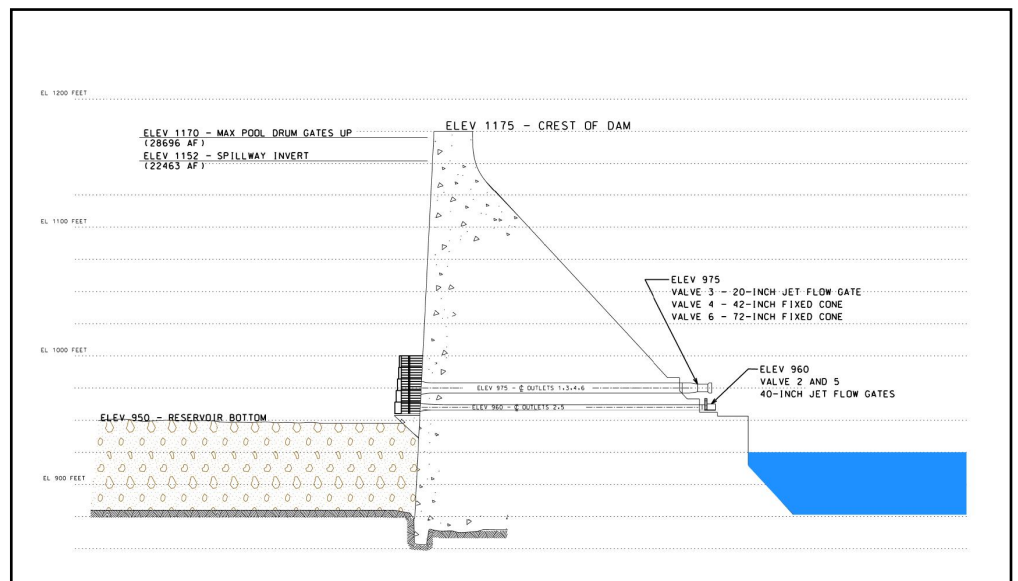
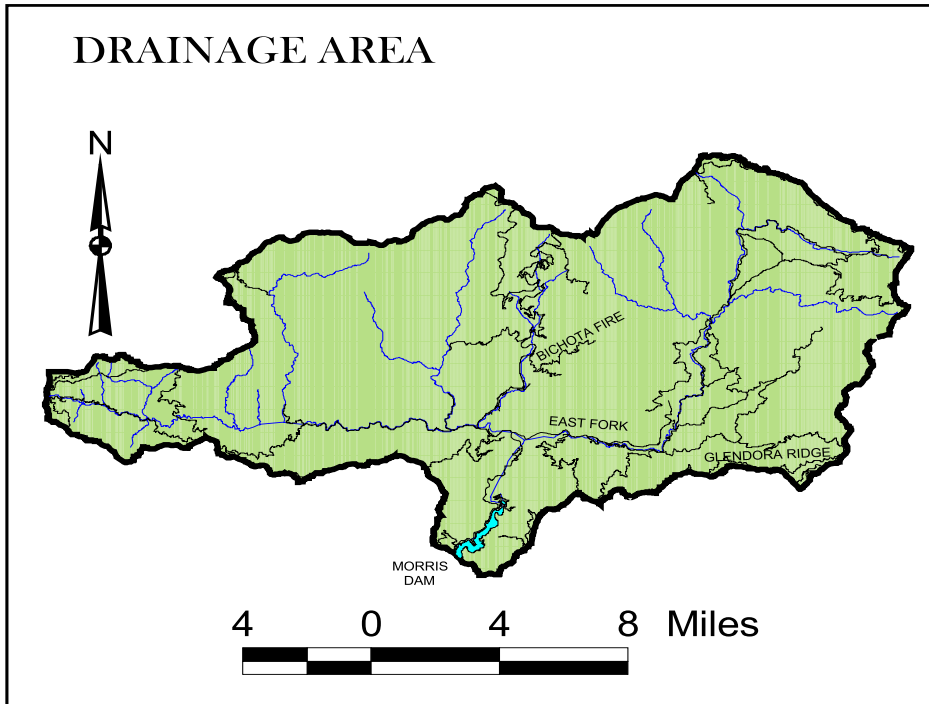

PURPOSE - Flood control and water conservation.

DATE CONSTRUCTED - Started April 1932. Completed 1935.

LOCATION - San Gabriel Canyon 5 miles north of Azusa.

DRAINAGE AREA - 8.7 square miles (uncontrolled)

202.7 square miles controlled by San Gabriel and Cogswell Dam.

Total 211.4 square miles.

CAPACITY (As of latest survey date) - 28,944 acre - feet.

SURVEY DATE - June 2013.

SPILLWAY ELEVATION - 1,152 feet.

PACOIMA DAM AND RESERVOIR

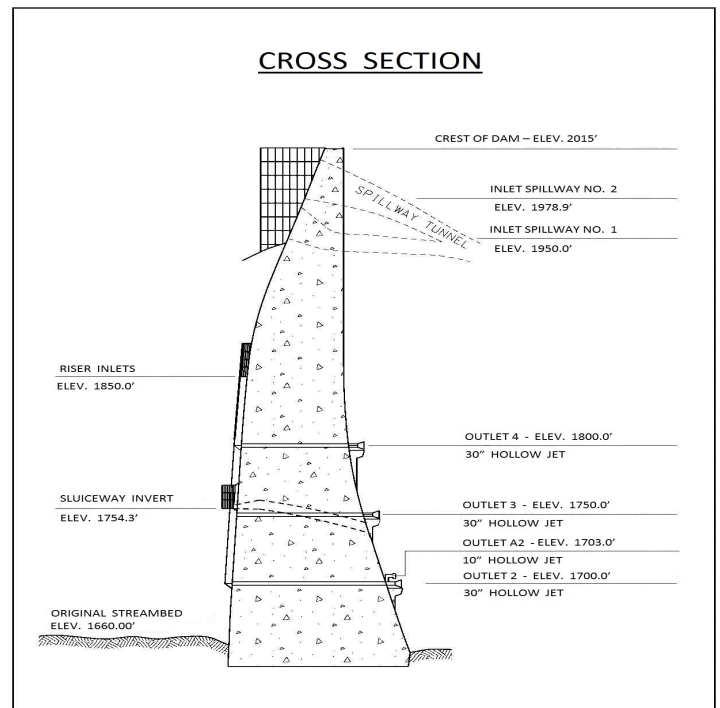
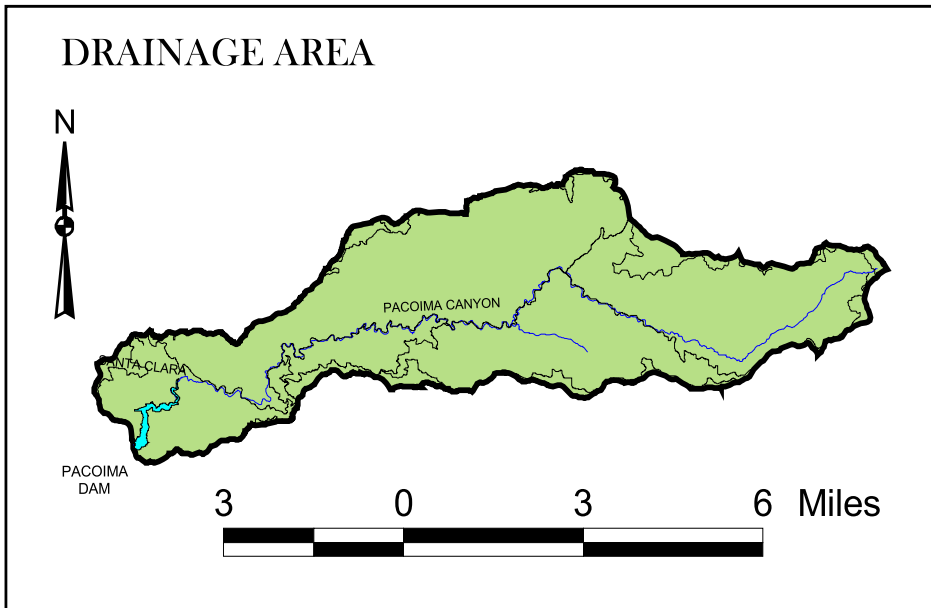

PURPOSE - Flood control and water conservation.

DATE CONSTRUCTED - Started March 1925. Completed February 1929.

LOCATION - Pacoima Canyon, 4.0 miles northeast of San Fernando.

DRAINAGE AREA - 28.2 square miles.

CAPACITY (As of latest survey date) - 2,830 acre - feet.

SURVEY DATE - October 2015.

SPILLWAY ELEVATION - 1,950 feet.

PUDDINGSTONE DAM AND RESERVOIR

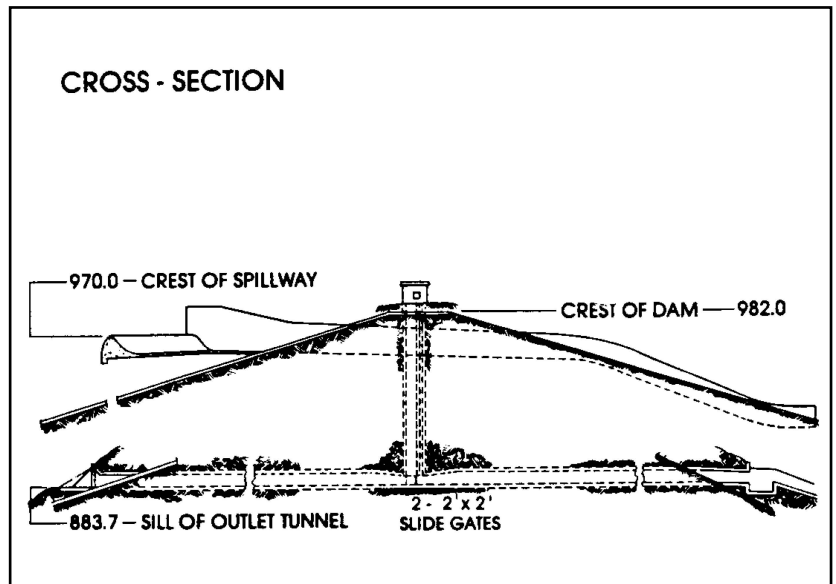
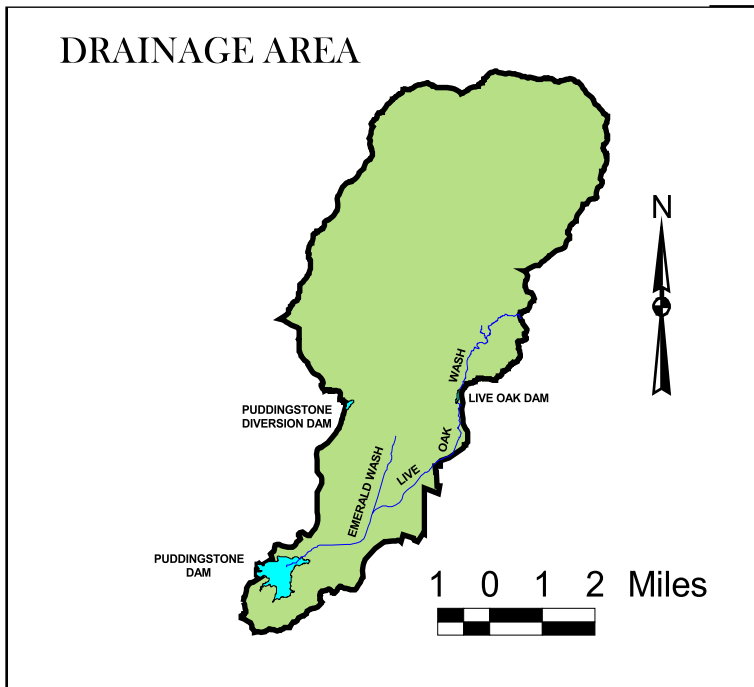

PURPOSE - Flood control and recreation.

DATE CONSTRUCTED - Started February 1925. Completed January 1928.

LOCATION - 1.0 miles south of San Dimas.

DRAINAGE AREA - 11.0 square miles (uncontrolled)
22.2 square miles (controlled)

Total 33.2 square miles.

CAPACITY (As of latest survey date) - 16,342 acre - feet.

SURVEY DATE - January 1986.

SPILLWAY ELEVATION - 970 feet.

PUDDINGSTONE DIVERSION DAM AND RESERVOIR

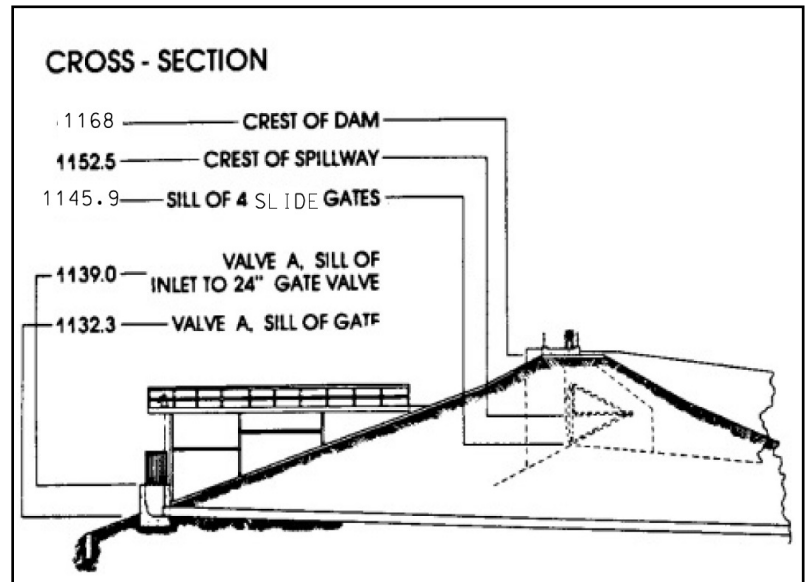
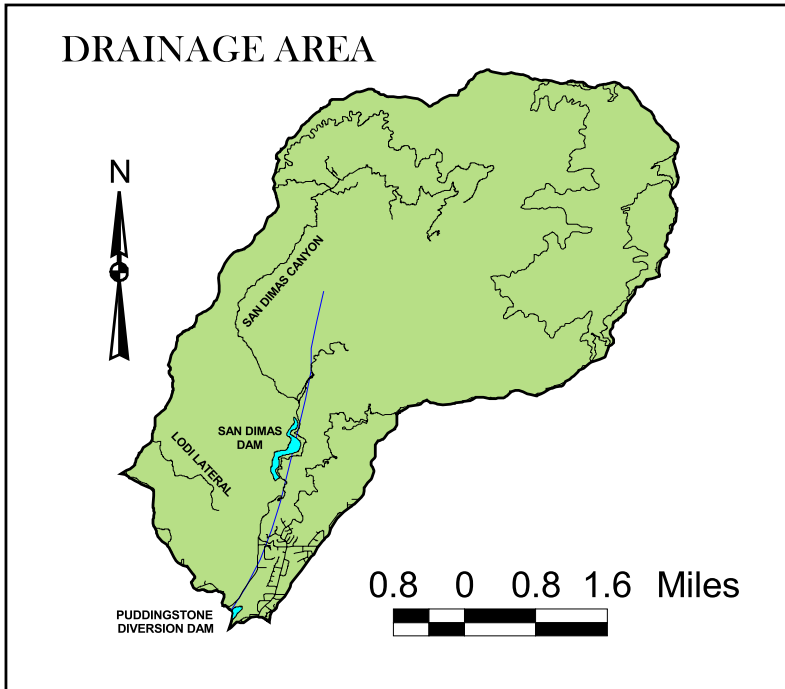

PURPOSE - Flood control, diversion of flow, and water conservation.

DATE CONSTRUCTED - Started September 1927. Completed July 1928.

LOCATION - 2.0 miles northeast of San Dimas.

DRAINAGE AREA - 3.7 square miles (uncontrolled)

16.2 square miles (controlled)

Total 19.9 square miles.

CAPACITY (As of latest survey date) - 205 acre - feet.

SURVEY DATE - August 2015.

SPILLWAY ELEVATION - 1,152.5 feet.

SAN DIMAS DAM AND RESERVOIR

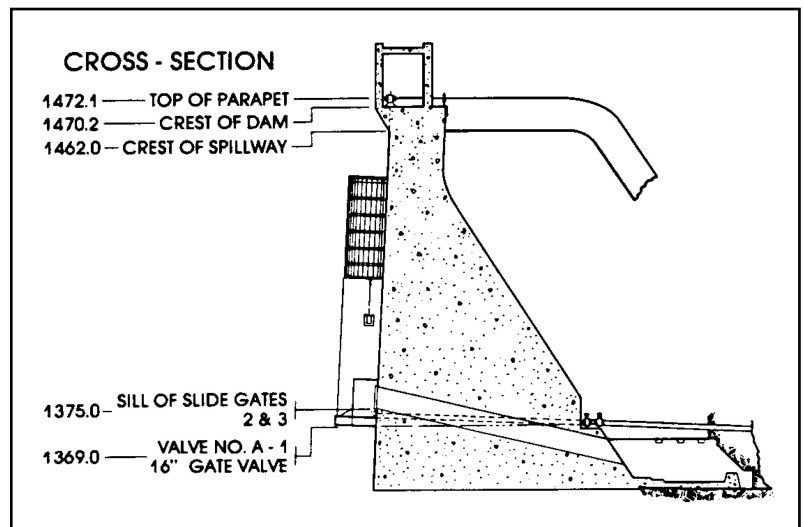
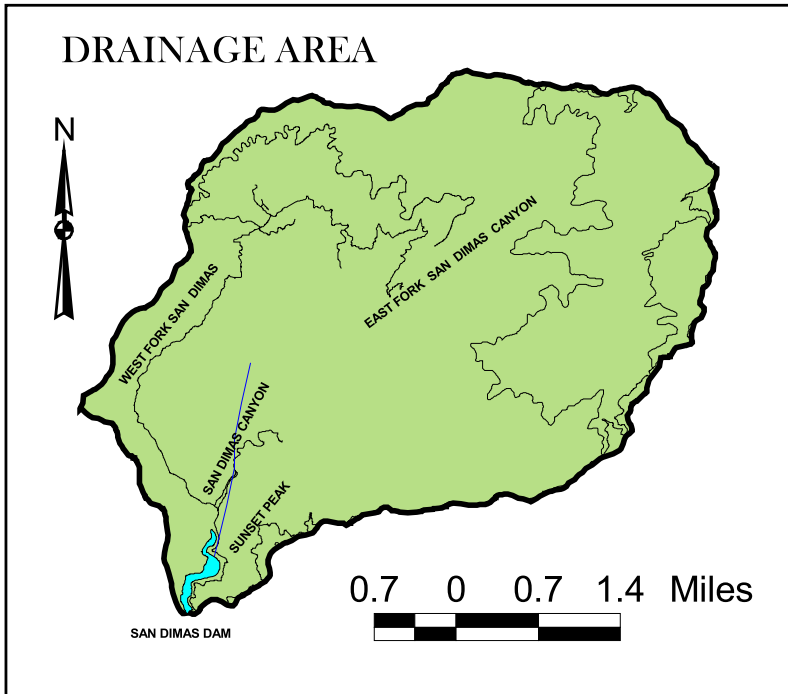

PURPOSE - Flood control and water conservation.

DATE CONSTRUCTED - Started November 1920. Completed September 1922.

LOCATION - 3.0 miles northeast of San Dimas.

DRAINAGE AREA - 16.2 square miles.

CAPACITY (As of latest survey date) - 1,548 acre - feet.

SURVEY DATE - July 2011.

SPILLWAY ELEVATION - 1,462 feet.

SAN GABRIEL DAM AND RESERVOIR

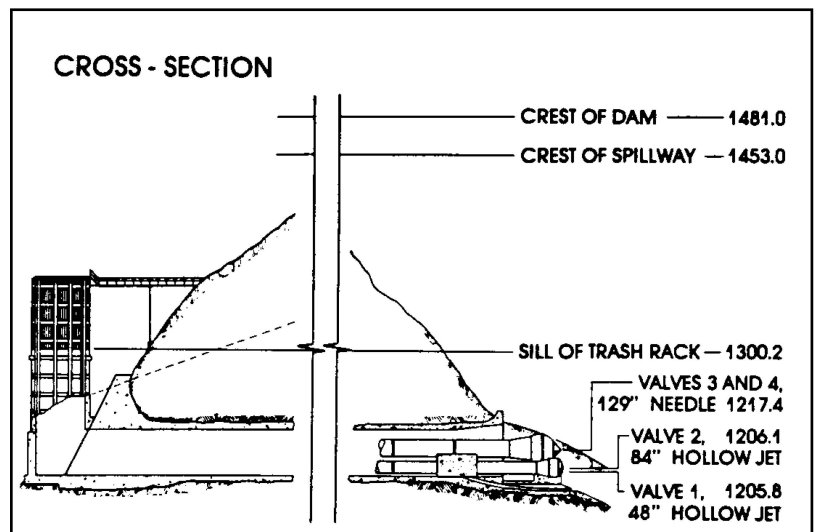
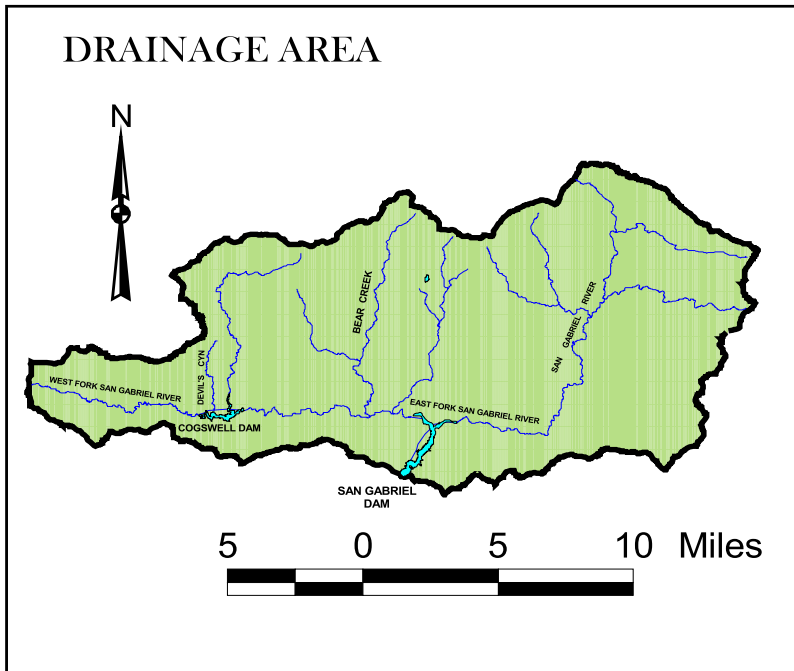

PURPOSE - Flood control and water conservation.

DATE CONSTRUCTED - Started December 1932. Completed July 1939.

LOCATION - San Gabriel Canyon, 7.5 miles north of Azusa.

DRAINAGE AREA - 163.5 square miles (uncontrolled)

39.2 square miles (controlled)

Total 202.7 square miles.

(includes Cogswell drainage)

CAPACITY (As of latest survey date) - 44,104 acre - feet.

SURVEY DATE - October 2014.

SPILLWAY ELEVATION - 1,453 feet.

SANTA ANITA DAM AND RESERVOIR

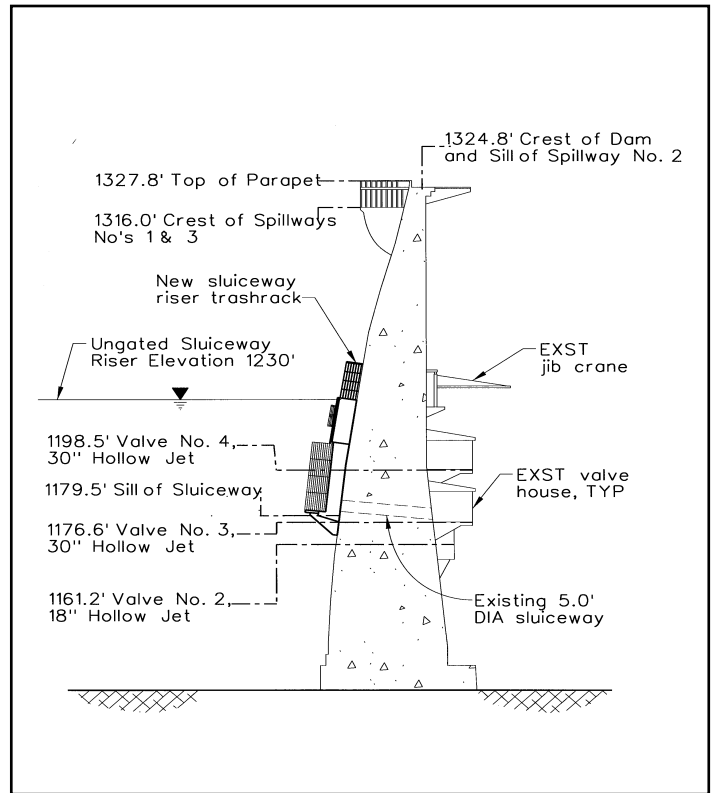
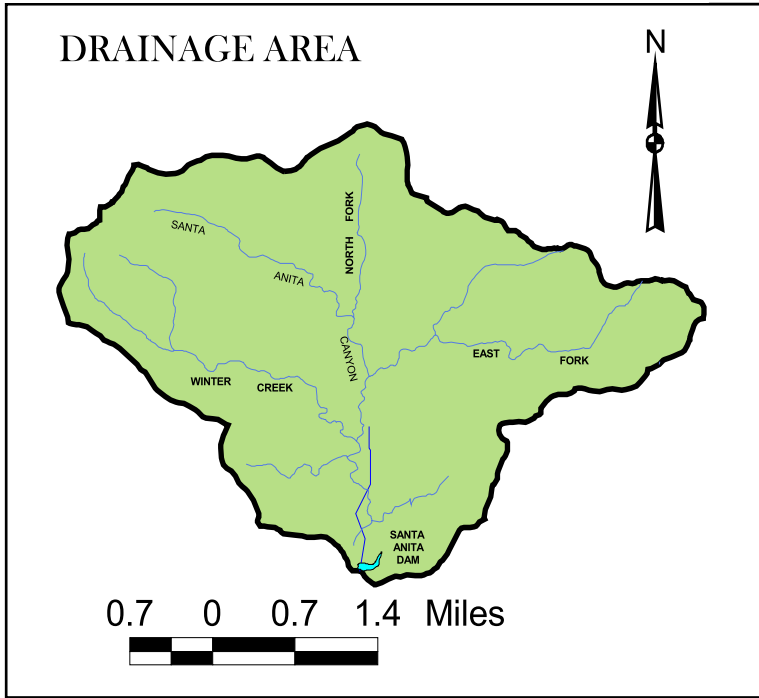

PURPOSE - Flood control and water conservation.

DATE CONSTRUCTED - Started October 1924. Completed March 1927.

LOCATION - 2.5 miles north of Arcadia.

DRAINAGE AREA - 10.8 square miles.

CAPACITY (As of latest survey date) - At crest: 1,111 acre - feet.

- At spillway: 974 acre - feet

- At 1230' restriction: 168 acre - feet

SURVEY DATE - October 2012.

SPILLWAY ELEVATION - 1,316 feet.

THOMPSON CREEK DAM AND RESERVOIR

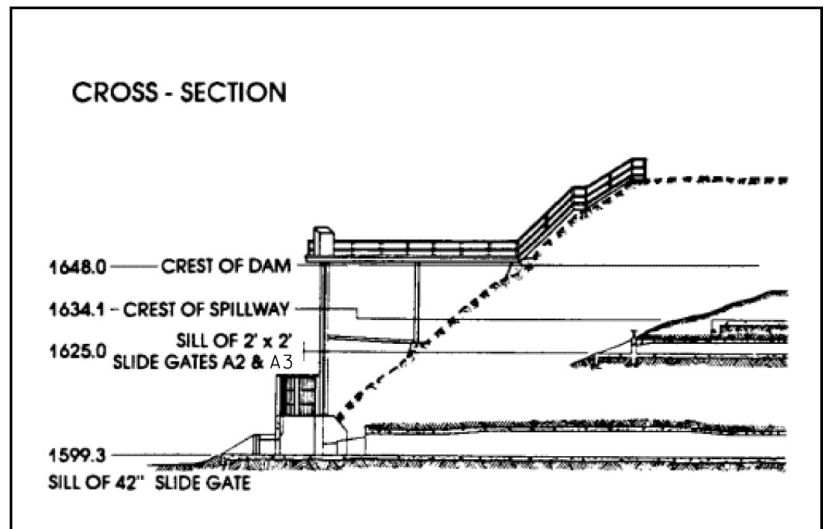
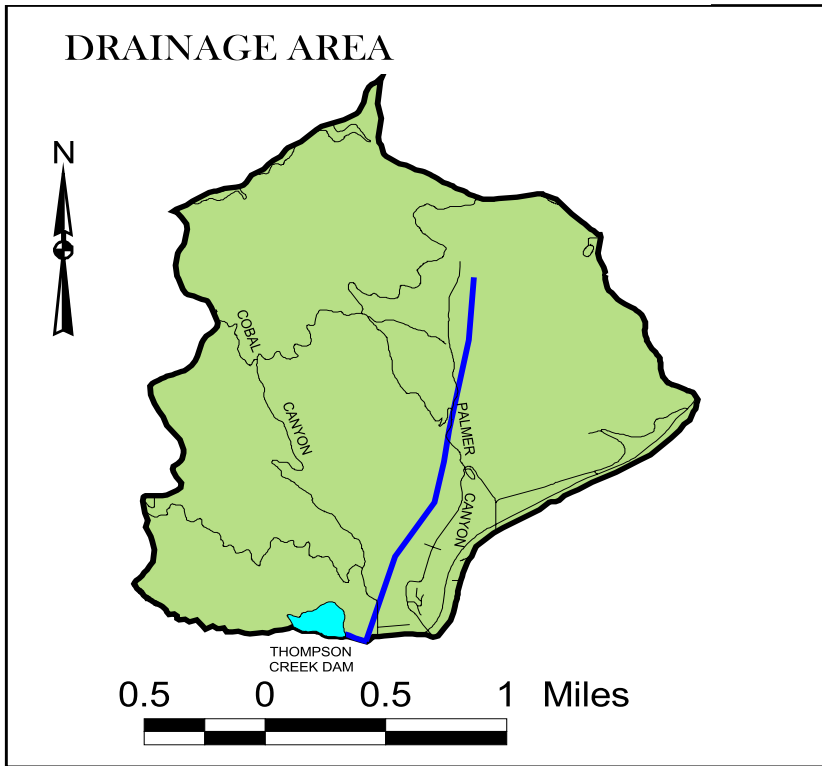

PURPOSE - Flood control and water conservation.

DATE CONSTRUCTED - Started September 1925. Completed March 1928.

LOCATION - 3.0 miles north of Claremont.

DRAINAGE AREA - 3.5 square miles.

CAPACITY (As of latest survey date) - 515 acre - feet.

SURVEY DATE - June 2004.

SPILLWAY ELEVATION - 1,634.1 feet.

RESERVOIRS

Reservoir Locations

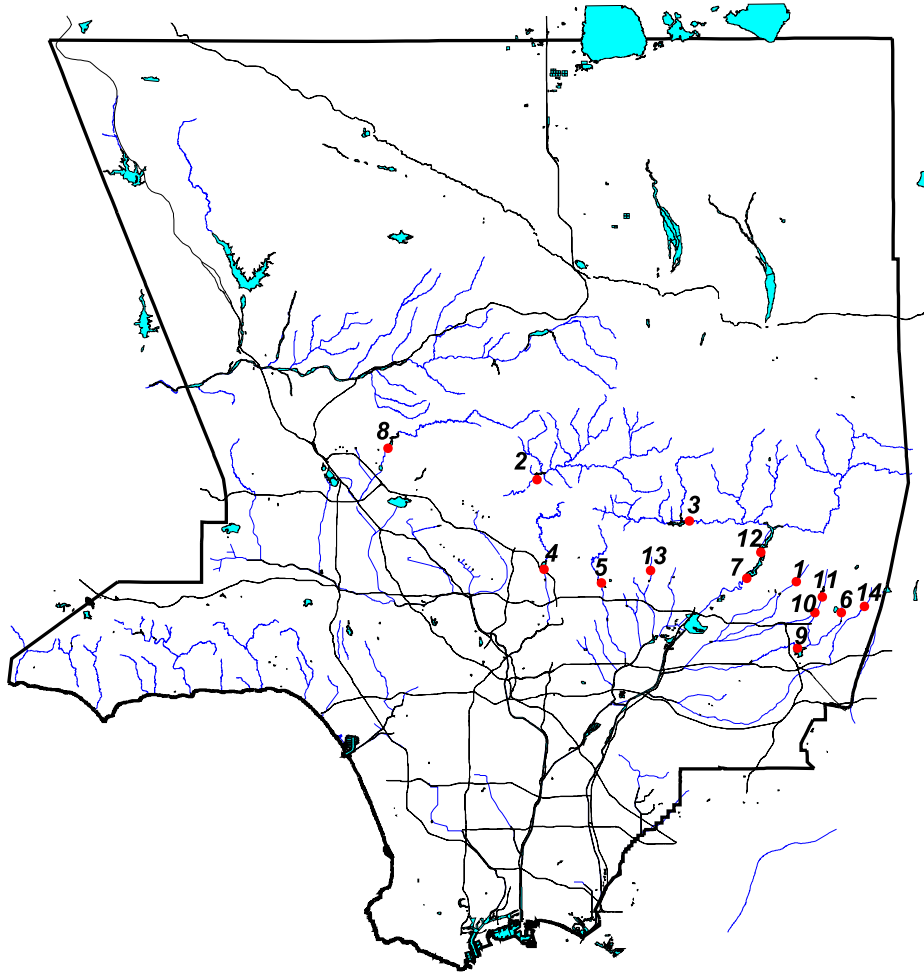

- | | | |
|---------------------|--------------------------------|------------------------|
| 1. Big Dalton Dam | 6. Live Oak Dam | 11. San Dimas Dam |
| 2. Big Tujunga Dam | 7. Morris Dam | 12. San Gabriel Dam |
| 3. Cogswell Dam | 8. Pacoima Dam | 13. Santa Anita Dam |
| 4. Devil's Gate Dam | 9. Puddingstone Dam | 14. Thompson Creek Dam |
| 5. Eaton Wash Dam | 10. Puddingstone Diversion Dam | |

EROSION CONTROL

EROSION CONTROL

Each year eroded material in various forms (debris consisting of rock, sand, trees, etc.) flows out of the mountain watersheds of the County of Los Angeles. In an effort to control this potentially disruptive force, Public Works maintains a series of debris basins in canyon mouths and upstream stabilization structures in selected watersheds.

DEBRIS BASINS:

The purpose of a debris basin is to entrap the sediment flows emanating from the canyon and let the relatively desilted water pass into the downstream flood control channels.

Public Works maintained over 100 debris basins during the reporting period. Their locations are shown in a PDF [map](#) (1.67MB).

This section contains a partial list of the debris basins maintained by Public Works. Data for sediment inflow at individual debris basins and unpublished information may be obtained by contacting:

**County of Los Angeles
Department of Public Works
Water Resources Division
Hydrology Section
P.O. Box 1460
Alhambra, CA 91802-1460
(626) 458-6120**

STABILIZATION STRUCTURES:

Public Works has constructed stabilization structures to control erosion in natural canyons. These structures serve to prevent down cutting by stabilizing alluvium deposits. In addition, they store debris generated by the watershed and serve to stabilize side banks, reducing side slope sloughing and bank erosion.

Public Works maintained 217 stabilization structures in 47 major watersheds during the reporting period. The Department has not constructed any stabilization structures since the 1973-74 water year.

EMERGENCY STRUCTURES:

Public Works has constructed emergency structures (rail and timber) to entrap the debris from burned watersheds. The structures serve to protect improvements (road, channel, residence, etc.) located downstream of the watersheds.

Watersheds within the County of Los Angeles periodically burn. Maps of areas burned during the reporting period can be obtained by contacting the Water Resources Division/Hydrology Section.

EROSION CONTROL

LOCATION MAP

(See Appendix F)

EROSION CONTROL

DEBRIS BASIN - DESIGN DATA:

Including 2014-2015 Storm Season
(Sedimentation Management Unit)

Debris Basin	First Debris Season	Uncontrolled Drainage Area Above Basin	Bottom Elev. at Max Cap.	Elevation Port Invert	Elevation Spillway Crest	Width Spillway	Elevation Crest of Dam	Maximum Debris Capacity
		(Sq. Mi.)	(Ft.)	(Ft.)	(Ft.)	(Ft.)	(AMSL)	(Cu. Yds.)
Aliso	1970-71	2.77	1,108	1,108	1,120	70.0	1,134	42,000 ⁽⁸⁾
Arbor Dell	1971-72	0.11	899	898	916	22.9	920	15,800
Auburn	1954-55	0.19	1,260	1,261	1,278	30.0	1,286	39,000
Bailey ⁽¹⁹⁾	1945-46	0.58	1,123	1,123	1,155	30.0	1,166	129,000
Beatty	1970-71	0.27	800	800	807	32.0	816	43,000
Big Dalton ⁽¹⁹⁾	1959-60	2.94	1,102	1,102 ⁽³⁾	1,132	116.0	1,148	580,000
Bigbriar	1971-72	0.02	1,898	1,896	1,910	14.0	1,911	2,600
Blanchard ⁽¹⁹⁾	1968-69	0.47	2,026	2,026	2,054	40.0	2,065	74,533
Blue Gum	1968-69	0.19	2,020	2,020	2,042	25.0	2,053	40,000
Brace	1971-72	0.29	1,190	1,190	1,196	20.0	1,205	30,000
Bracemar	1971-72	0.01	1,140	1,140	1,146	8.0	1,148	700 ⁽¹⁴⁾
Bradbury	1954-55	0.68	912	913	920	58.0	928	90,000
Brand ⁽¹⁹⁾	1964-65	1.03	860	860	890	23.0	903	170,000
Buena Vista	1985-86	0.10	979	979	992	39.0	998	22,000
Carriage House	1970-71	0.03	1,350	1,350	1,363	15.0	1,367	6,100
Carter	1954-55	0.12	1,224	1,223	1,248	30.0	1,255	28,000
Cassara	1976-77	0.21	1,272	1,272	1,292	66.0	1,295	37,000
Chamberlain	1974-75	0.04	1,085	1,084	1,098	20.0	1,101	4,700
Chandler	1995-96	0.16	1,055	1,052	1,073	36.0	1,078	20,000 ⁽¹⁵⁾
Childs	1963-64	0.30	1,022	1,022	1,059	23.0	1,071	50,000
Cloud Creek	1972-73	0.01	2,350	2,351	2,360	⁽⁹⁾	2,362	5,100
Cloudcroft	1973-74	0.21	314	315	330	36.0	330	35,000
Cooks	1951-52	0.58	2,058	2,058	2,083	48.0	2,092	52,000
Cooks M-1A	1975-76	⁽¹³⁾	2,120	0 ⁽¹⁰⁾	2,142	⁽¹⁰⁾	0 ⁽¹⁰⁾	34,000
Crescent Glen	2001-02	0.07	1,149	1,149	1,171	19.3	1,174	21,000
Crestview	1983-84	0.03	864	864	886	20.0	892	5,900 ⁽¹⁴⁾
Crocker	1983-84	0.67	1,064	1,064	1,070	36.0	1,077	19,000 ⁽¹⁴⁾
Deer	1954-55	0.59	1,185	1,185	1,201	56.0	1,210	57,000
Denivelle	1976-77	0.18	1,471	1,471	1,479	46.0	1,483	7,900
Devonwood	1981-82	0.05	1,899	1,899	1,922	⁽¹⁶⁾	1,928	11,000
Dry Canyon-South Fork	1978-79	0.49	1,063	1,063	1,075	32.0	1,079	7,900
Dunsmuir	1935-36	0.84	2,228	2,228	2,257	60.0	2,272	103,000
Eagle	1936-37	0.48	1,850	1,846	1,880	60.0	1,895	63,000
Elmwood	1964-65	0.31	912	912	938	22.0	952	61,000

FOOTNOTES

- (1) Lowest clear water outlet, not spillway.
- (2) Elevation of spillway notch.
- (3) Flow line of sluiceway.
- (4) Elevation of spillway into outlet channel. Elevation of overflow spillway 1,036.9 feet.
- (5) One 30-inch reinforced concrete pipe.
- (6) Four 36-inch corrugated metal pipes.
- (7) One 36-inch reinforced concrete pipe. (Elevated inlet)
- (8) Debris capacity available within right of way limits.
- (9) Pit-type basin.
- (10) Information unavailable.
- (11) Special cleanout required due to limited storage.
- (12) Cleanout required when debris reaches or exceeds elevation 1128.9 feet against face of dam.
- (13) Values are combined with Cooks debris basin.
- (14) Spillway level storage capacity.
- (15) Data taken from design drawings.
- (16) 7 feet in diameter circular outlet type.
- (17) The maximum capacities have been rounded off with regard to appropriate precision consistent with the assumptions used in the development of Hydrology and Sedimentation Manual.
- (18) New maximum capacity based on "As-Built" topographic map number 78B-T56.
- (19) Under the jurisdiction of the Division of Safety of Dams (DSOD).

EROSION CONTROL

DEBRIS BASIN - DESIGN DATA:

Including 2014-2015 Storm Season
(Sedimentation Management Unit)

Debris Basin	First Debris Season	Uncontrolled Drainage Area Above Basin	Bottom Elev. at Max Cap.	Elevation Port Invert	Elevation Spillway Crest	Width Spillway	Elevation Crest of Dam	Maximum Debris Capacity
Emerald-East	1964-65	0.15	1,185	1,181	1,192	30.0	1,204	13,600
Englewild	1961-62	0.44	1,275	1,275	1,297	50.0	1,300	41,000
Fair Oaks	1935-36	0.20	1,544	1,544	1,562	⁽⁶⁾	1,567	24,000
Fern	1935-36	0.31	1,440	1,440	1,476	25.0	1,482	43,000
Fieldbrook	1974-75	0.35	713	713	722	28.0	728	11,100 ⁽¹⁵⁾
Golf Club Drive	1970-71	0.99	881	881	902	36.7	915	15,000
Gooseberry	1998-99	0.19	1,440	1,440	1,460	25.0	1,469	35,000
Gordon	1973-74	0.18	1,076	1,075	1,096	22.0	1,105	35,600
Gould	1947-48	0.36	1,530	1,528	1,548	55.0	1,558	53,000
Gould (Upper)	1976-77	0.18	1,864	1,864	1,898	32.0	1,901	52,000
Halls	1935-36	0.83	1,642	1,642	1,662	131.0	1,664	94,000
Harrow	1958-59	0.43	1,255	1,255	1,269	40.0	1,278	68,000
Haven Way	1991-92	0.13	1,323	1,323	1,329	20.0	1,336	38,200
Hay	1936-37	0.20	1,890	1,890	1,908	36.0	1,915	37,000
Hillcrest	1962-63	0.35	864	864	885	18.0	901	58,000
Hog	1969-70	0.32	1,520	1,520	1,535	32.0	1,547	43,000
Hook East	1968-69	0.18	1,198	1,198	1,215	37.0	1,222	33,800
Hook West	1970-71	0.17	1,145	1,145	1,165	40.0	1,172	33,700
Inverness	1982-83	0.03	1,253	1,253	1,257	20.0	1,261	3,300
Irving Drive	1974-75	0.03	906	905	915	12.0	920	1,200
Kinneloa	1964-65	0.20	1,370	1,370	1,403	76.0	1,408	36,000 ⁽¹⁵⁾
Kinneloa - West	1966-67	0.19	1,385	1,385	1,413	22.0	1,421	35,000
La Tuna ⁽¹⁹⁾	1955-56	5.34	1,109	1,110	1,140	75.0	1,157	530,000
Lannan	1954-55	0.25	1,017	1,015	1,036	14.0	1,043	41,000
Las Flores	1935-36	0.45	1,685	0 ⁽⁹⁾	1,716	50.0	1,726	56,000
Las Lomas	1983-84	0.07	887	887	906	77.0	909	17,000
Limekiln	1963-64	3.72	992	992	1,003	77.0	1,019	172,000
Lincoln	1935-36	0.50	1,276	1,276	1,304	56.0	1,323	38,000
Linda Vista	1970-71	0.37	980	980	990	40.0	996	3,200
Little Dalton ⁽¹⁹⁾	1959-60	3.31	1,140	1,140	1,186	84.0	1,200	661,000
Maddock	1954-55	0.26	889	892	901	36.0	904	45,000
Marston/Paragon	1988-89	0.20	1,456	1,456	1,460	20.0	1,466	5,300
May No. 1	1953-54	0.70	1,666	1,666	1,684	60.0	1,693	64,000
May No. 2	1953-54	0.09	1,663	1,664 ⁽²⁾	1,670	20.0	1,674	13,000

FOOTNOTES

- (1) Lowest clear water outlet, not spillway.
- (2) Elevation of spillway notch.
- (3) Flow line of sluiceway.
- (4) Elevation of spillway into outlet channel. Elevation of overflow spillway 1,036.9 feet.
- (5) One 30-inch reinforced concrete pipe.
- (6) Four 36-inch corrugated metal pipes.
- (7) One 36-inch reinforced concrete pipe. (Elevated inlet)
- (8) Debris capacity available within right of way limits.
- (9) Pit-type basin.
- (10) Information unavailable.
- (11) Special cleanout required due to limited storage.
- (12) Cleanout required when debris reaches or exceeds elevation 1128.9 feet against face of dam.
- (13) Values are combined with Cooks debris basin.
- (14) Spillway level storage capacity.
- (15) Data taken from design drawings.
- (16) 7 feet in diameter circular outlet type.
- (17) The maximum capacities have been rounded off with regard to appropriate precision consistent with the assumptions used in the development of Hydrology and Sedimentation Manual.
- (18) New maximum capacity based on "As-Built" topographic map number 78B-T56.
- (19) Under the jurisdiction of the Division of Safety of Dams (DSOD).

EROSION CONTROL

DEBRIS BASIN - DESIGN DATA:

Including 2014-2015 Storm Season
(Sedimentation Management Unit)

Debris Basin	First Debris Season	Uncontrolled Drainage Area Above Basin	Bottom Elev. at Max Cap.	Elevation Port Invert	Elevation Spillway Crest	Width Spillway	Elevation Crest of Dam	Maximum Debris Capacity
		(Sq. Mi.)	(Ft.)	(Ft.)	(Ft.)	(Ft.)	(AMSL)	(Cu. Yds.)
Monument	1981-82	0.11	944	942	950	12.0	954	7,000
Morgan ⁽¹⁹⁾	1964-65	0.60	1,138	1,138	1,162	38.0	1,171.5	79,100
Mountbatten	1983-84	0.01	1,136	1,136	1,145	20.0	1,146	3,300
Mull	1973-74	0.15	1,147	1,147	1,154	20.0	1,165	13,000
Mullally (11)	1974-75	0.34	2,420	2,420	2,435	42.0	2,440	9,400
Nichols	1937-38	0.94	480	481	485	50.0	495	14,000
Oak	1975-76	0.05	2,144	2,146	2,153	50.0	2,156	13,000
Oak Park	2001-02	0.07	1,042	1,042	1,060	18.7	1,064	15,000
Oakglade	1974-75	0.06	1,275	1,280	1,298	20.0	1,305	15,200
Oakmont View Drive	1984-85	0.02	1,316	1,316	1,328	20.0	1,329	3,400
Oliver	1989-90	0.18	1,258	1,258	1,278	41.0	1,283	32,000
Pickens	1935-36	1.50	1,564	1,564	1,600	123.0	1,613	125,000
Pinelawn	1973-74	0.02	2,431	2,431	2,443	⁽⁷⁾	2,449	3,200
Rowley	1953-54	0.21	1,704	1,704	1,714	60.0	1,722	43,000
Rowley (Upper)	1976-77	0.31	1,926	1,926	1,946	42.0	1,951	29,000
Rubio ⁽¹⁹⁾	1943-44	1.71	1,582	1,577	1,611	59.0	1,626	150,000
Ruby (Lower)	1955-56	0.28	811	810	834	45.0	840	40,200
Rye	1981-82	1.11	1,074	1,074	1,078	58.2	1,082	19,000
Saddleback	1988-89	0.04	1,781	1,779	1,791	23.5	1,797	16,000
Santa Anita ⁽¹⁹⁾	1959-60	2.00	748	749 ⁽³⁾	775	160.0	796	395,000
Sawpit ⁽¹⁹⁾	1954-55	3.04	930	930	982	110.0	1,000	636,000
Scholl	1945-46	0.66	950	950 ⁽²⁾	956	76.0	966	9,300
Schoolhouse ⁽¹⁹⁾	1962-63	0.28	1,460	1,460	1,478	20.0	1,491	66,700
Schwartz	1976-77	0.25	1,295	1,295	1,313	35.0	1,319	45,000
Shields	1937-38	0.06	2,050	2,050	2,058	30.0	2,070	20,000
Sierra Madre Dam ⁽¹²⁾	1927-28	2.47	1,118	1,118	1,172	62.5	1,175	136,000
Sierra Madre Villa ⁽¹⁹⁾	1957-58	1.50	1,069	1,069	1,089	48.0	1,103	402,700
Snover	1936-37	0.21	1,863	1,863	1,879	40.0	1,894	25,000
Sombrero	1969-70	1.06	1,540	1,540	1,565	45.0	1,580	88,000
Spinks	1958-59	0.44	750	750	762	40.0	766	56,000
Starfall	1973-74	0.13	2,428	2,428	2,442	30.0	2,447	15,000
Stetson	1969-70	0.29	1,556	1,555	1,570	32.0	1,579	41,000
Stough ⁽¹⁹⁾	1960-61	1.65	1,006	1,006	1,032 ⁽⁴⁾	100.0	1,044	158,000
Sturtevant	1967-68	0.03	975	971	984	8.0	990	1,400

FOOTNOTES

- (1) Lowest clear water outlet, not spillway.
- (2) Elevation of spillway notch.
- (3) Flow line of sluiceway.
- (4) Elevation of spillway into outlet channel. Elevation of overflow spillway 1,036.9 feet.
- (5) One 30-inch reinforced concrete pipe.
- (6) Four 36-inch corrugated metal pipes.
- (7) One 36-inch reinforced concrete pipe. (Elevated inlet)
- (8) Debris capacity available within right of way limits.
- (9) Pit-type basin.
- (10) Information unavailable.
- (11) Special cleanout required due to limited storage.
- (12) Cleanout required when debris reaches or exceeds elevation 1128.9 feet against face of dam.
- (13) Values are combined with Cooks debris basin.
- (14) Spillway level storage capacity.
- (15) Data taken from design drawings.
- (16) 7 feet in diameter circular outlet type.
- (17) The maximum capacities have been rounded off with regard to appropriate precision consistent with the assumptions used in the development of Hydrology and Sedimentation Manual.
- (18) New maximum capacity based on "As-Built" topographic map number 78B-T56.
- (19) Under the jurisdiction of the Division of Safety of Dams (DSOD).

EROSION CONTROL

DEBRIS BASIN - DESIGN DATA:

Including 2014-2015 Storm Season
(Sedimentation Management Unit)

Debris Basin	First Debris Season	Uncontrolled Drainage Area Above Basin	Bottom Elev. at Max Cap.	Elevation Port Invert	Elevation Spillway Crest	Width Spillway	Elevation Crest of Dam	Maximum Debris Capacity
		(Sq. Mi.)	(Ft.)	(Ft.)	(Ft.)	(Ft.)	(AMSL)	(Cu. Yds.)
Sullivan	1970-71	2.38	570	570	587	50.0	599	51,000
Sunnyside	1970-71	0.02	1,290	1,290	1,300	15.0	1,304	3,400
Sunset (Lower) ⁽¹⁹⁾	1963-64	1.09	1,004	995	1,040	40.0	1,056	158,900
Sunset (Upper)	1928-29	0.44	1,574	1,574	1,604	75.0	1,610	16,000
Sunset Canyon-Deer	1982-83	0.21	1,382	1,381	1,402	24.0	1,409	5,000
Turnbull	1952-53	0.99	476	476	492	40.0	503	22,000
Upper Shields	1976-77	0.22	2,498	2,498	2,530	33.0	2,537	40,000
Verdugo	1935-36	9.40	1,110	1,110	1,120	145.0	1,131	131,000
Ward	1956-57	0.12	2,022	2,022	2,043	58.0	2,045	26,000
West Ravine	1935-36	0.25	1,484	1,470 ⁽¹⁾	1,502	20.0	1,506	39,000
Westridge	1974-75	0.02	894	894	905	10.7	906	4,200 ⁽¹⁴⁾
Wildwood	1967-68	0.65	1,343	1,343	1,354	50.0	1,360	21,000
William S. Hart Park	1983-84	0.09	1,282	1,280	1,290	19.0	1,293	2,400
Wilson ⁽¹⁹⁾	1962-63	2.58	1,493	1,493	1,526	60.0	1,543	316,900
Winery	1968-69	0.18	1,920	1,920	1,935	20.0	1,945	29,000
Zachau	1956-57	0.35	1,803	1,803	1,820	44.0	1,828	48,000
118 DEBRIS BASINS		75.77						7,907,900

FOOTNOTES

- (1) Lowest clear water outlet, not spillway.
- (2) Elevation of spillway notch.
- (3) Flow line of sluiceway.
- (4) Elevation of spillway into outlet channel. Elevation of overflow spillway 1,036.9 feet.
- (5) One 30-inch reinforced concrete pipe.
- (6) Four 36-inch corrugated metal pipes.
- (7) One 36-inch reinforced concrete pipe. (Elevated inlet)
- (8) Debris capacity available within right of way limits.
- (9) Pit-type basin.
- (10) Information unavailable.
- (11) Special cleanout required due to limited storage.
- (12) Cleanout required when debris reaches or exceeds elevation 1128.9 feet against face of dam.
- (13) Values are combined with Cooks debris basin.
- (14) Spillway level storage capacity.
- (15) Data taken from design drawings.
- (16) 7 feet in diameter circular outlet type.
- (17) The maximum capacities have been rounded off with regard to appropriate precision consistent with the assumptions used in the development of Hydrology and Sedimentation Manual.
- (18) New maximum capacity based on "As-Built" topographic map number 78B-T56.
- (19) Under the jurisdiction of the Division of Safety of Dams (DSOD).

EROSION

DEBRIS BASIN - DEBRIS MANAGEMENT SUMMARY

Debris Basin	DPA Zone	Number of Seasons	Debris Deposited*	Maximum Debris Production**	Cumulative Debris Removed
			(Cu. Yds.)	(Cu. Yds.)	(Cu. Yds.)
Aliso	4	46	0	52,206	330,127
Arbor Dell	2	45	0	4,294	8,603
Auburn	1	62	0	24,164	109,596
Bailey	1	71	0	116,309	321,126
Beatty	1	45	4,047	18,353	36,510
Big Dalton	1	56	0	296,680	1,208,452
Bigbriar	1	35	0	4,517	9,485
Blanchard	1	48	0	36,593	106,617
Blue Gum	1	48	0	19,123	49,251
Brace	2	45	0	11,971	42,628
Bracemar	2	35	0	393	676
Bradbury	1	60	0	70,219	274,167
Brand	1	77	0	109,195	487,118
Buena Vista	1	30	0	402	490
Carriage House	1	45	0	3,459	7,725
Carter	1	62	0	12,559	53,409
Cassara	1	40	0	10,301	32,647
Chamberlain	2	41	0	437	1,156
Chandler	2	20	0	200	200
Childs	1	52	0	30,154	101,952
Cloud Creek	1	44	0	3,931	8,165
Cloudcroft	4	42	0	6,060	13,992
Cooks	1	64	0	53,092	200,494
Cooks M-1A	1	40	0	33,741	89,688
Crescent Glen	1	15	0	1,148	1,148
Crestview	1	30	0	60	60
Crocker	8	33	0	5,745	13,706
Deer	1	62	0	44,186	177,248
Denivelle	2	40	0	5,477	13,647
Devonwood	1	34	0	5,818	10,325
Dry Canyon-South Fork	4	37	0	5,325	16,009
Dunsmuir	1	80	0	122,482	509,220
Eagle	1	78	0	41,690	229,530
Elmwood	1	51	0	16,089	57,891
Emerald-East	2	50	4,239	4,239	18,140
Englewild	1	54	14,154	60,194	144,564
Fair Oaks	1	80	0	15,711	116,816
Fern	1	80	0	23,867	189,106
Fieldbrook	6	41	0	489	2,210
Golf Club Drive	2	46	0	11,631	45,859
Gooseberry	1	20	0	1,682	2,709
Gordon	1	43	0	3,810	8,409
Gould	1	68	0	23,684	141,198
Gould Upper	1	38	0	46,332	88,302
Halls	1	71	0	150,624	556,941
Harrow	1	58	20,078	63,393	124,078
Haven Way	2	45	0	11,823	15,350
Hay	1	78	0	58,671	138,796
Hillcrest	1	53	0	11,659	67,313
Hog	1	48	0	22,410	49,786
Hook East	1	47	6,620	40,153	73,115
Hook West	1	45	5,532	10,180	23,210
Inverness	2	33	0	1,341	1,804
Irving Drive	2	41	0	577	1,617

* Debris Deposited is an estimated figure based on the number of truckloads of debris removed from the basin Page 19

** Maximum Debris Production since previous basin cleanout.

EROSION

DEBRIS BASIN - DEBRIS MANAGEMENT SUMMARY

Debris Basin	DPA Zone	Number of Seasons	Debris Deposited*	Maximum Debris Production**	Cumulative Debris Removed
			(Cu. Yds.)	(Cu. Yds.)	(Cu. Yds.)
Kinneloa East	1	50	0	30,899	107,395
Kinneloa West	1	50	0	43,499	160,495
La Tuna	2	60	0	172,051	697,221
Lannan	1	62	0	18,243	90,264
Las Flores	1	76	0	35,600	246,554
Las Lomas	1	33	0	48	58
Limekiln	4	52	0	55,055	458,954
Lincoln	1	80	0	48,289	177,885
Linda Vista	2	40	0	3,400	17,856
Little Dalton	1	56	0	337,789	1,329,180
Maddock	1	61	0	16,170	56,006
Marston_Paragon	5	27	0	879	1,949
May No.1	2	62	0	45,771	270,408
May No.2	2	62	0	6,176	34,455
Monument	6	34	0	345	999
Morgan	1	51	0	12,923	39,214
Mountbatten	1	32	0	60	182
Mull	1	42	0	1,052	3,036
Mullally	1	41	0	57,569	135,840
Nichols	4	78	0	24,106	139,406
Oak	1	40	0	6,911	20,591
Oak Park	1	15	0	0	0
Oakglade	1	41	0	1,242	1,657
Oakmont View Drive	1	31	0	221	686
Oliver	1	39	0	16,255	33,580
Pickens	1	80	0	174,738	937,290
Pinelawn	1	42	0	5,296	10,871
Rowley Lower	1&7	62	0	16,659	85,814
Rowley Upper	1	39	0	31,884	66,106
Rubio	1	72	0	133,045	424,489
Ruby Lower	1	60	0	8,302	21,722
Rye	5	34	0	10,049	19,619
Saddleback	1	25	0	2,440	5,010
Santa Anita	1	56	0	171,176	1,041,139
Sawpit	1	61	0	233,834	742,080
Scholl	2	70	0	3,457	23,363
Schoolhouse	1	53	0	21,627	47,481
Schwartz	1	39	0	23,359	60,669
Shields	1	78	0	35,147	166,097
Sierra Madre Dam	1	78	0	95,170	371,077
Sierra Madre Villa	1	58	0	171,775	794,822
Snover	1	78	0	60,665	174,076
Sombrero	1	46	0	26,830	129,507
Spinks	1	57	0	16,361	74,956
Starfall	1	42	0	16,041	43,162
Stetson	1	46	0	14,161	50,060
Stough	2	75	0	29,577	185,088
Sturtevant	1	48	0	457	1,841
Sullivan	4	45	0	47,000	177,181
Sunnyside	1	45	0	1,621	4,351
Sunset Canyon-Deer	1	34	0	3,678	6,808
Sunset Lower	1	72	0	35,290	170,264
Sunset Upper	1	74	0	27,037	155,793
Turnbull	6	63	0	15,864	78,991

* Debris Deposited is an estimated figure based on the number of truckloads of debris removed from the basin.

** Maximum Debris Production since previous basin cleanup.

EROSION

DEBRIS BASIN - DEBRIS MANAGEMENT SUMMARY

Debris Basin	DPA Zone	Number of Seasons	Debris Deposited*	Maximum Debris Production**	Cumulative Debris Removed
			(Cu. Yds.)	(Cu. Yds.)	(Cu. Yds.)
Upper Shields	1	39	0	41,790	97,207
Verdugo	1	78	0	108,654	991,171
Ward Lower	1	71	0	17,769	86,147
West Ravine	1	80	0	29,866	172,651
Westridge	1&7	32	0	187	258
Wildwood	3&5	48	4,128	16,699	127,981
William S Hart Park	5	31	0	321	490
Wilson	2	53	0	62,830	432,750
Winery	1	47	0	53,424	89,935
Zachau	1	59	0	48,060	144,428

* Debris Deposited is an estimated figure based on the number of truckloads of debris removed from the basin.

** Maximum Debris Production since previous basin cleanout.

WATER CONSERVATION

Information presented in this section includes amounts of local, imported, and reclaimed water conserved in groundwater recharge areas and information on the seawater barrier projects which prevent salt water intrusion into groundwater zones in the coastal areas. Pertinent data is presented regarding the locations and descriptions of Public Works' water conservation facilities as well as facilities owned by others. Additional data not presented in this report or its appendices can be obtained by contacting the [custodian](#) of hydrologic records.

CONSERVING THE WATERS

In addition to the flood control program, Public Works has the equally important mission of conserving as much of the storm and other waters as practicable. The use of water conservation facilities adjacent to river channels and in soft-bottom channels permits water to percolate into groundwater basins for later pumping. These groundwater recharge facilities are located in areas where the underlying soils are composed of permeable formations and in hydraulic connection with the underlying aquifer.

The various types of water conserved, local, imported, and reclaimed are construed to have the following meanings in this section: Local water is primarily runoff due to rainfall on the mountain and valley watersheds, dam releases, and rising water within the County. Imported water is water originating outside the County either from Northern California or from the Colorado River. Reclaimed water is the effluent produced by the Whittier Narrows Water Reclamation Plant, the San Jose Creek Water Reclamation Plant, and the Pomona Water Reclamation Plant, all operated by the County of Los Angeles Sanitation District. Reclaimed water is also injected at the seawater barriers. Both West Basin and the Department of Water and Power provide tertiary treated water used for direct injection.

The importance of this activity is apparent when it is realized that about 30 to 40 percent of the water used in the County is pumped from groundwater supplies. The growth of the County, combined with periodic droughts, has seriously depleted these supplies on numerous occasions.

Public Works' policy is to conserve the maximum possible amount of storm water consistent with runoff quantity and quality, capacities of the spreading facilities, and groundwater conditions.

IMPORTED WATER

During the reporting period, Public Works received water imported from the Colorado River and the State Water Project by the Metropolitan Water District (MWD) and spread it in the Coastal Plain at Public Works' Rio Hondo and San Gabriel Coastal Spreading Grounds on behalf of the Water Replenishment District of Southern California. MWD water is also spread in the Main San Gabriel Basin, Upper San Gabriel Canyon Basin, and Glendora Basin.

Public Works spreads imported water from MWD and the San Gabriel Valley Municipal Water District (SGVMWD) in the San Gabriel Valley on behalf of, the Upper San Gabriel Valley Municipal Water District, and the Three Valleys Municipal Water District in the following facilities:

- San Gabriel Canyon Spreading Grounds
- Santa Fe Spreading Grounds
- San Gabriel River
- Little Dalton Spreading Grounds
- Forbes Spreading Grounds
- Irwindale Spreading Basin/Manning Pit
- Citrus Spreading Grounds
- Ben Lomond Spreading Grounds
- Valley Rubber Dam Spreading Areas

WATER CONSERVATION

RECYCLED WATER

The County Sanitation District's Whittier Narrows Water Reclamation Plant effluent purchased by the Water Replenishment District of Southern California is transported to the Rio Hondo and San Gabriel Coastal Basin Spreading Grounds for groundwater replenishment.

The County Sanitation District's San Jose Creek Water Reclamation Plant made its first delivery of effluent in November 1972. The effluent released into San Jose Creek, San Gabriel River, or directly delivered to San Gabriel Coastal Spreading Ground via pipeline can be purchased by the Water Replenishment District of Southern California.

Water from the Pomona Reclamation Plant is released down the San Jose Creek - San Gabriel River System to Public Works' recharge facilities in the Central Basin spreading grounds.

The maximum amount of reclaimed water allowed for spreading in the Montebello Forebay, effective July 1991, is 60,000 acre-feet per year but not to exceed 150,000 acre-feet over a three-year period.

SEAWATER BARRIER PROJECTS

Public Works operates three barrier projects to protect the groundwater in the West Coast and Central Basins against seawater intrusion by creating freshwater pressure ridges along the coastline. The pressure ridges are created by injecting freshwater through a series of injection wells. The amounts of water injected by these wells during the reporting period are as follows:

Facility	Imported Water (Acre-Feet)	Recycled Water (Acre-Feet)
Alamitos Barrier Project:		
Los Angeles Portion	4,219	502
Orange County Portion*	1,817	233
Dominguez Gap Barrier Project	3,338	4,173
West Coast Basin Barrier Project	2,411	12,670

**Injected on behalf of the Orange County Water District*

SEASONAL DATA AND MAPS

During the reporting period, weekly, monthly, and semi-annual measurements of groundwater levels in observation wells located throughout the groundwater basins in the County of Los Angeles were made and processed.

Locations of the key wells noted herein are shown on the well map in the Water Conservation Summary section. Historical key well level data can be viewed in [Appendix L](#).

WATER CONSERVATION

Static groundwater elevation contour maps for the three major groundwater regions in the County of Los Angeles are available from the local basin water agencies:

Groundwater Basin	Contact
Upper Los Angeles River Area (San Fernando Valley)	Upper Los Angeles River Watermaster P.O. Box 111, Room 1455 Los Angeles, CA 90051 (213) 367-1020 (213) 367-1131 (FAX)
San Gabriel Valley	Main San Gabriel Basin Watermaster 729 North Azusa Avenue Azusa, CA 91702 (626) 815-1300 (626) 815-1303 (FAX)
Coastal Plain	Water Replenishment District of Southern California 12621 East 166th Street Cerritos, CA 90703 (562) 921-5521

GROUNDWATER BASINS AND GROUNDWATER RECHARGE

Groundwater in the County of Los Angeles is stored in basins underlying five major geographic areas. These groundwater basins are separated by geologic features which impede groundwater movement or by political boundaries. A map of these groundwater basins and Public Works' spreading grounds is available upon request from Public Works. General spreading grounds facility information is included in the summary section. Monthly water conservation data for the reporting period at Public Works' facilities and other pertinent facilities are included in the Water Conservation Summary section of this report. The monthly imported and recycled water deliveries for the reporting period are also included in the Water Conservation Summary section. The following is a background summary of Public Works' groundwater recharge activities within each of these major areas:

LOS ANGELES COUNTY-WIDE

Public Works operates 2,436 acres of spreading grounds and soft-bottom channel spreading areas for replenishment of local groundwater supplies. Public Works also assisted in the operation and maintenance of 269 acres of spreading grounds owned by others. An additional 656 acres of spreading grounds are controlled maintained and operated by other agencies. The total gross acreage of spreading grounds in the County of Los Angeles is 3,361 acres.

Groundwater replenishment consists of storm runoff, imported water, and recycled water. Countywide, Public Works spread the following amounts during the reporting period:

County Rainfall Index (% of Normal)	71
Storm Runoff (acre-feet)	59,784
Imported Water (acre-feet)	48,324
Recycled Water (acre-feet)	44,349

WATER CONSERVATION

Public Works is continuing its efforts to improve its water spreading facilities in order to maximize the amounts of water conserved and to simplify the spreading operations.

SAN GABRIEL VALLEY

Public Works operates 20 spreading facilities in the San Gabriel Valley that receive direct valley runoff and flows from the San Gabriel Mountains. Some of these facilities can also receive imported water. Valleywide, Public Works spread the following amounts during the reporting period:

Total Storm Runoff * (acre-feet)	40,559
Imported Water (acre-feet)	29,659
Diversions to Grounds Owned by Others (acre-feet)	14,402

* Includes Runoff from Fish Canyon & Sierra Madre Spreading Grounds.

Public Works' spreading grounds replenished the Valley's several groundwater basins as follows:

	Storm Water (acre-feet)	Imported Water (acre-feet)	Key Wells
Main San Gabriel Basin	23,645	9,563	3030F, 2965C
Upper San Gabriel Canyon Basin	16,068	20,096	4284A
Lower San Gabriel Canyon Basin	84		4285
Wayhill Basin	0	0	
Foothill Basin	328		
Glendora Basin	50	0	
Claremont Heights Basin			4508A, 4508B
Live Oak Basin		0	
Chino Basin			
San Dimas Basin	2	0	
Pomona Basin			3251E, 3261P, 4469A
Puente and Spadra Basins			
Raymond Basin	382		4057H

WATER CONSERVATION

COASTAL PLAIN

The groundwater basins underlying the Coastal Plain are divided by geological features into the Central (includes the Montebello and Los Angeles Forebays), West Coast, Santa Monica, and Hollywood Basins. Most of the water is spread in the Montebello Forebay. Public Works spread the following amounts in the Coastal Plain during the reporting period:

Storm Runoff (acre-feet)	15,988
Imported Water (acre-feet)	18,515
Recycled Water (acre-feet)	44,349

Central Basin

The Central Basin has the most storage capacity of the basins in the Coastal Plain. In addition to the water recharged in Public Works' spreading facilities, water injected in the Alamitos Barrier Project also contributes to the replenishment of the pressure aquifers underlying the Central Basin. The basin contains Key Well Nos. 460K, 1601T, and 906D.

West Coast Basin

The West Coast basin is the second largest basin underlying the Coastal Plain and is separated by the Newport-Inglewood Fault zone. Groundwater is primarily recharged by Central Basin subsurface flows and by water injected by Public Works in the West Coast Basin and Dominguez Gap Barrier Projects. Groundwater elevations in the West Coast basin are below sea level except in the area of the West Coast Basin Barrier injection mound. The basin contains Key Well Nos. 1346D and 760C.

Santa Monica and Hollywood Basins

There are no Public Works spreading facilities in either of these basins.

SAN FERNANDO VALLEY

The San Fernando Valley is also known as the Upper Los Angeles River Area (ULARA). Most of the runoff from the surrounding mountains flows to the Valley. The Valley is composed of four basins:

San Fernando Main Basin

The basin is the largest basin underlying the San Fernando Valley. The basin contains Key Well Nos. 3872H and 4709. Public Works spread the following during the reporting period:

Storm Runoff (acre-feet)	3,237
Imported Water (acre-feet)	150
Recycled Water (acre-feet)	0

WATER CONSERVATION

Sylmar, Verdugo, and Eagle Rock Basins

Public Works has no spreading facilities in these much smaller basins.

SANTA CLARITA VALLEY

Public Works has no spreading facilities in the area. Much of the Valley is open space, permitting substantial natural percolation. The Upper Santa Clarita subunit comprises five basins.

ANTELOPE VALLEY

There are several groundwater subbasins underlying the Antelope Valley. Five of them are located within the County of Los Angeles. Public Works operates no spreading facilities in the Antelope Valley. Key Well Nos. 9974 and 8825 are located in the Lancaster and Little Rock sub basins, respectively.

WATER CONSERVATION

SUMMARY

PUBLIC WORKS FACILITIES

(See Appendix G)

OTHER FACILITIES

(See Appendix H)

TOTAL MONTHLY WATER CONSERVED

(See Appendix I)

IMPORTED WATER OUTLET RELEASES

(See Appendix J)

RECLAIMED WATER

(See Appendix K)

GROUND WATER FLUCTUATION

(See Appendix L)

Select groundwater well level data by clicking on the Well Number below.

Location	Well No.	Ground Surface Elev. (ft)
Coastal Plain, City of Long Beach	0460K	26.6
Coastal Plain	0760C	50.0
Coastal Plain, City of Long Beach	0906D	88.8
Central Basin	1601T	159.7
Main San Gabriel Basin	2965C	245.0
Main San Gabriel Basin, Baldwin Park	3030F	386.7
Pomona Basin	3261P	999.4
San Fernando Valley, Canoga Park	3600H	788.5
San Fernando Valley, Burbank	3872H	546.5
Raymond Basin	4057H	749.9
San Gabriel Canyon Basin, North of Azusa	4284A	658.8
Upper Claremont Heights	4508A	1482.0
Santa Clarita Valley, Near Castaic Junction	7057P	1131.0
Little Rock, South of Palmdale	8825	2777.0
Antelope Valley, South of Lancaster	9974	2512.0

WATER CONSERVATION

KEYWELL MAP

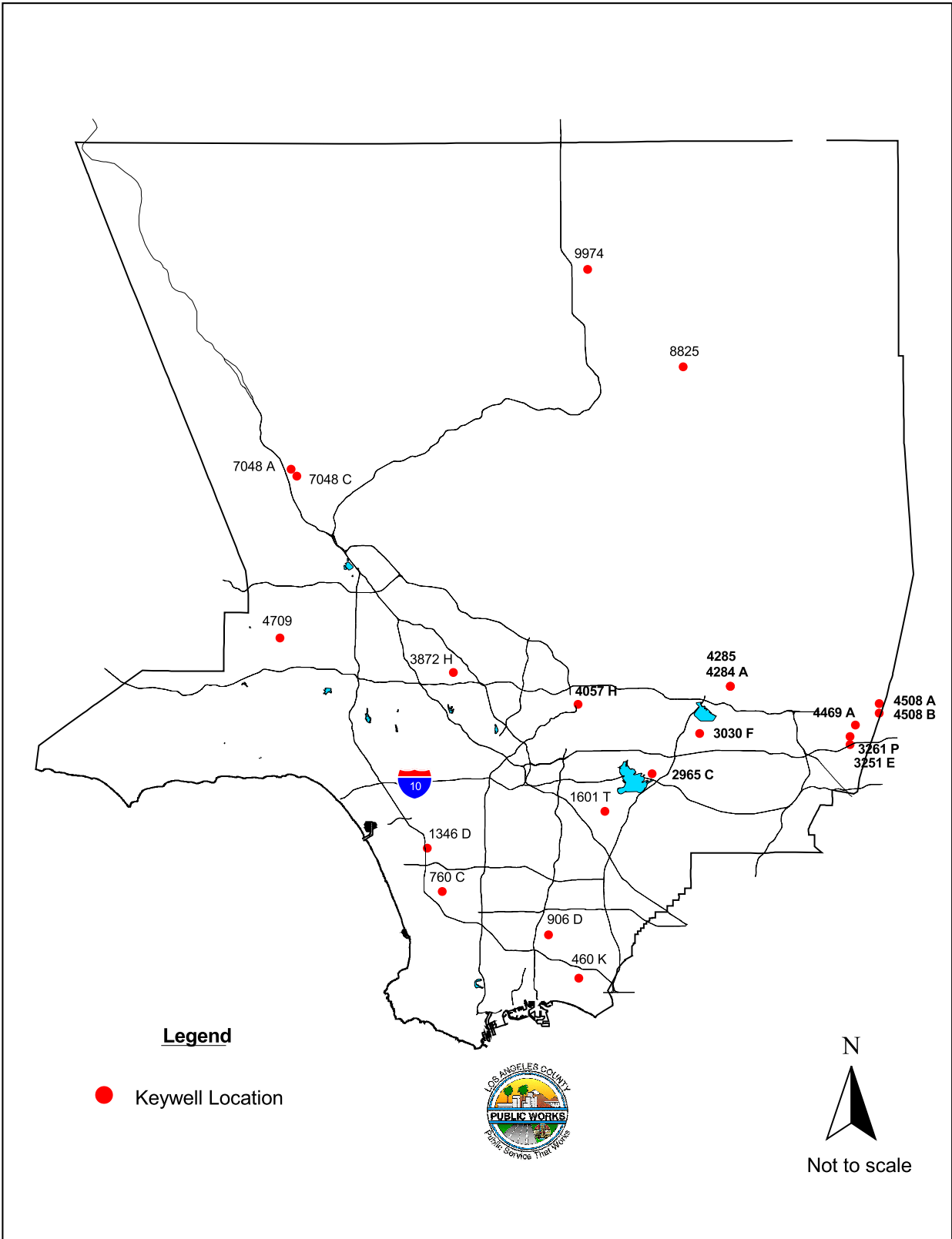

APPENDIX A

HYDROLOGIC REPORT 2014 – 2015

PRECIPITATION - DAILY RAINFALL SUMMARY

PRECIPITATION

DAILY RAINFALL SUMMARY

13C North Hollywood-Lakeside

Gage Type: Standard Gage

Observation Time: Figures are for a 24-hour period

Latitude 34-08-46

Longitude: 118-21-13

Elevation: 550 Feet

Water Year from 10/01/2014 to 09/30/2015

Day	Oct	Nov	Dec	Jan	Feb	Mar	Apr	May	Jun	Jul	Aug	Sep
1		0.49	0.65			0.43						
2		0.03				1.71						
3			1.15			0.02						
4			0.07									
5												
6												
7												
8					0.14		0.07	0.10				
9												
10												
11				0.88								
12			0.78	0.09								
13			1.01									
14												
15								0.14				0.79
16			0.02					0.03				1.01
17			1.23									
18												
19						0.04				0.26		
20										0.04		
21												
22												
23					0.43							
24					0.06							
25												
26							0.09					
27				0.15								
28												
29												
30				0.02						0.01		
31			0.03	0.11								
Totals	0.00	0.52	4.94	1.25	0.63	2.20	0.16	0.27	0.00	0.31	0.00	1.80
										Water Year Total:		12.08

NOTE: All Values are in units of inches, unless otherwise specified.

LEGEND: A - Acculated Total
 E - Estimated
 T - Trace, unmeasurable amount of rain

PRECIPITATION

DAILY RAINFALL SUMMARY

21B Woodland Hills

Gage Type: Standard Gage

Observation Time: Figures are for a 24-hour period

Latitude 34-10-14

Longitude: 118-35-33

Elevation: 875 Feet

Water Year from 10/01/2014 to 09/30/2015

Day	Oct	Nov	Dec	Jan	Feb	Mar	Apr	May	Jun	Jul	Aug	Sep
1		0.35				0.62E						
2			1.39			0.31E						
3			0.46			0.03E						
4			0.03									
5												
6												
7					0.06							
8								0.01				
9									0.05			
10				0.26					0.01			
11				0.80								
12			1.64									
13												
14		0.05						0.06				
15								0.16				0.55
16			0.22									
17			0.12									
18										0.55		
19										0.12		
20										0.04		
21		0.01										
22					0.02							
23					0.13							
24												
25								0.01				
26												
27				0.39								
28												
29												
30		0.70		0.03								
31												
Totals	0.00	1.11	3.86	1.48	0.21	0.96	0.01	0.23	0.06	0.71	0.00	0.55
												Water Year Total: 9.18

NOTE: All Values are in units of inches, unless otherwise specified.

LEGEND: A - Acculated Total
 E - Estimated
 T - Trace, unmeasurable amount of rain

Data Revised: April 2016
A - 2

PRECIPITATION

DAILY RAINFALL SUMMARY

33A Pacoima Dam

Gage Type: Standard Gage

Observation Time: Figures are for a 24-hour period

Latitude 34-19-48

Longitude: 118-23-59

Elevation: 1500 Feet

Water Year from 10/01/2014 to 09/30/2015

Day	Oct	Nov	Dec	Jan	Feb	Mar	Apr	May	Jun	Jul	Aug	Sep
1		0.41	0.44			0.33						
2		0.01	0.01			0.54						
3			1.69			0.14						
4			0.05									
5								T				
6												
7												
8					0.09		0.11	0.03				
9								T				
10									T			
11				1.17								
12			1.06	0.02								
13			0.60									
14												
15								0.33				0.94
16			0.03									0.10
17			0.70									
18								T				
19						0.03		T		0.31		
20										0.62		
21		T										
22												
23					0.82							
24					0.06							
25												
26							0.08					
27				0.10								
28					T							
29												
30												
31				0.30								
Totals	0.00	0.42	4.58	1.59	0.97	1.04	0.19	0.36	0.00	0.93	0.00	1.04
										Water Year Total:		11.12

NOTE: All Values are in units of inches, unless otherwise specified.

LEGEND: A - Acculated Total
 E - Estimated
 T - Trace, unmeasurable amount of rain

PRECIPITATION

DAILY RAINFALL SUMMARY

42C Redondo Beach-City Hall

Gage Type: Standard Gage

Observation Time: Figures are for a 24-hour period

Latitude 33-50-43

Longitude: 118-23-20

Elevation: 70 Feet

Water Year from 10/01/2014 to 09/30/2015

Day	Oct	Nov	Dec	Jan	Feb	Mar	Apr	May	Jun	Jul	Aug	Sep
1		0.69				0.46				0.01		
2		0.09	1.23			0.46						
3			0.23			0.32						
4												
5												
6												
7					0.01		0.26					
8								0.17				
9									0.05			0.01
10				0.53								
11			0.01	0.35					0.02			
12			1.44						0.02			
13		0.02										
14								0.25				
15								0.10				0.54
16			0.35									
17			0.10									
18										0.40		
19										0.14		
20										0.01		
21										0.01		
22						0.44				0.02		
23						0.15						
24												
25								0.05				
26				0.22								
27												
28												
29												
30			0.32	0.04								
31	0.09											
Totals	0.09	0.80	3.68	1.14	0.60	1.24	0.31	0.52	0.09	0.59	0.00	0.55
										Water Year Total:		9.61

NOTE: All Values are in units of inches, unless otherwise specified.

LEGEND: A - Acculated Total
 E - Estimated
 T - Trace, unmeasurable amount of rain

PRECIPITATION

DAILY RAINFALL SUMMARY

43D Palos Verdes Estates

Gage Type: Standard Gage

Observation Time: Figures are for a 24-hour period

Latitude 33-47-58

Longitude: 118-23-29

Elevation: 216 Feet

Water Year from 10/01/2014 to 09/30/2015

Day	Oct	Nov	Dec	Jan	Feb	Mar	Apr	May	Jun	Jul	Aug	Sep
1		0.35	0.01			0.13				0.01		
2		0.34	1.10			0.66				0.02		
3			0.27			0.33						
4			0.10									
5												
6												
7								0.04				
8					0.02		0.11	0.54				
9												
10									0.10			T
11				0.88					T			
12			1.74	0.03		T						
13			0.03						0.03			
14		0.02										
15								0.84				0.42
16			0.26					0.06				0.05
17			0.48									
18												
19										0.52		
20										0.18		
21										T		
22										0.02		
23					0.42							
24												
25												
26							0.02					
27				0.25								
28												
29												
30				0.01								
31			0.64	0.02								
Totals	0.00	0.71	4.63	1.19	0.44	1.12	0.13	1.48	0.13	0.75	0.00	0.47
											Water Year Total:	11.05

NOTE: All Values are in units of inches, unless otherwise specified.

LEGEND: A - Acculated Total
 E - Estimated
 T - Trace, unmeasurable amount of rain

PRECIPITATION

DAILY RAINFALL SUMMARY

46D Big Tujunga Dam

Gage Type: Standard Gage

Observation Time: Figures are for a 24-hour period

Latitude 34-17-40

Longitude: 118-11-14

Elevation: 2315 Feet

Water Year from 10/01/2014 to 09/30/2015

Day	Oct	Nov	Dec	Jan	Feb	Mar	Apr	May	Jun	Jul	Aug	Sep
1		0.94	0.48			0.36						
2			0.01			0.41						
3			1.43			0.05						
4			0.10									
5									T			
6												
7												
8					0.22		0.24	0.30				
9									T			
10									0.01			
11				1.03					T			
12			2.02	0.05								
13			1.12									
14								0.34				
15								0.51				1.33
16			T					0.01				0.24
17			0.72									
18												
19						0.04				0.57		
20										1.87		
21		0.08								T		
22						T						
23						1.01						
24						0.30						
25												
26								0.18				
27				0.05								
28						0.02						
29												
30												
31				0.03						0.02		
Totals	0.00	1.02	5.88	1.16	1.55	0.86	0.42	1.16	0.01	2.46	0.00	1.57
										Water Year Total:		16.09

NOTE: All Values are in units of inches, unless otherwise specified.

LEGEND: A - Acculated Total
 E - Estimated
 T - Trace, unmeasurable amount of rain

Data Revised: April 2016
A - 6

PRECIPITATION

DAILY RAINFALL SUMMARY

63C Santa Anita Dam

Gage Type: Standard Gage

Observation Time: Figures are for a 24-hour period

Latitude 34-11-03

Longitude: 118-01-12

Elevation: 1400 Feet

Water Year from 10/01/2014 to 09/30/2015

Day	Oct	Nov	Dec	Jan	Feb	Mar	Apr	May	Jun	Jul	Aug	Sep
1		0.59	0.37			0.08						
2		0.06	0.04			0.27						
3			1.96			0.40						
4			0.49						0.01			
5									0.05			
6												
7												
8					0.15		0.44	0.52				
9								T				
10									0.03	T		
11				0.91								
12			1.42	0.20								
13			1.01						0.03			
14								0.02				
15								1.01				1.47
16			0.03					0.02				0.79
17			0.76									
18			0.02					T				
19						0.03				0.34		
20										1.33		
21		0.05										
22					0.03					0.01		
23					1.39					0.02		
24					0.37							
25							0.01					
26							0.21					
27				0.15								
28					0.10							
29												
30												
31			0.21							0.01		
Totals	0.00	0.70	6.31	1.26	2.04	0.78	0.66	1.57	0.12	1.71	0.00	2.26
										Water Year Total:		17.41

NOTE: All Values are in units of inches, unless otherwise specified.

LEGEND: A - Acculated Total
 E - Estimated
 T - Trace, unmeasurable amount of rain

Data Revised: April 2016
 A - 7

PRECIPITATION

DAILY RAINFALL SUMMARY

82F **Table Mountain**

Gage Type: Standard Gage

Observation Time: Figures are for a 24-hour period

Latitude 34-22-56

Longitude: 117-40-39

Elevation: 7420 Feet

Water Year from 10/01/2014 to 09/30/2015

Day	Oct	Nov	Dec	Jan	Feb	Mar	Apr	May	Jun	Jul	Aug	Sep
1		0.65				0.11				0.08		
2			2.18E			A						
3			0.70E			0.10A						
4			0.06E									
5												
6									0.01		0.14	
7							0.03	A				
8								0.02A				
9									0.38			0.09
10				A								T
11			A	1.26A		0.02						
12			0.57A						0.89			0.02
13									0.05			
14								A				
15			A					0.25A				1.28
16			A									
17			0.90A									
18			0.01			0.20				0.73		
19										2.65E		
20		0.04								0.15E		
21							0.08					
22					A		0.11					
23					A		0.11					
24					0.90A							
25												T
26				A								
27				A								
28				0.49A								
29										0.35		
30		0.15	0.40	A						0.31		
31				0.57A								
Totals	0.00	0.84	4.82	2.32	0.90	0.43	0.33	0.27	1.33	4.27	0.14	1.39
										Water Year Total:		17.04

NOTE: All Values are in units of inches, unless otherwise specified.

LEGEND: A - Acculated Total

 E - Estimated

 T - Trace, unmeasurable amount of rain

Data Revised: April 2016

A - 8

PRECIPITATION

DAILY RAINFALL SUMMARY

89B **San Dimas Dam**

Gage Type: Standard Gage

Observation Time: Figures are for a 24-hour period

Latitude 34-09-10

Longitude: 117-46-17

Elevation: 1350 Feet

Water Year from 10/01/2014 to 09/30/2015

Day	Oct	Nov	Dec	Jan	Feb	Mar	Apr	May	Jun	Jul	Aug	Sep
1		A	0.34			A						
2		0.35A	T			0.71A						
3			1.78									
4			0.60									
5												
6									0.04			
7												
8							0.44	0.39				
9					0.05			0.03E				
10												
11				A								
12			1.10	0.94A								
13			0.68						A			
14									0.33A			
15								0.57E				0.55
16			0.02					0.07				0.89
17			0.89									
18												
19										A		
20										0.88A		
21		0.16										
22												
23					0.91			0.10				
24					0.42							
25												
26							0.15					
27				0.32								
28						A						
29												
30				T								
31			0.25									
Totals	0.00	0.51	5.66	1.26	1.38	0.71	0.59	1.16	0.37	0.88	0.00	1.44
										Water Year Total:		13.96

NOTE: All Values are in units of inches, unless otherwise specified.

LEGEND: A - Acculated Total

 E - Estimated

 T - Trace, unmeasurable amount of rain

Data Revised: April 2016

A - 9

PRECIPITATION

DAILY RAINFALL SUMMARY

93C **Claremont-Police Station**

Gage Type: Standard Gage

Observation Time: Figures are for a 24-hour period

Latitude 34-05-45

Longitude: 117-43-18

Elevation: 1170 Feet

Water Year from 10/01/2014 to 09/30/2015

Day	Oct	Nov	Dec	Jan	Feb	Mar	Apr	May	Jun	Jul	Aug	Sep
1		0.74	0.22			0.26				0.06		
2			1.25			0.16						
3			0.49									
4			0.64									
5												
6												
7								0.07				
8							0.25	0.48				
9				0.03								
10				0.02					0.01			
11				0.62					0.01			
12			1.50						0.04			
13			0.05									
14								0.21				
15								0.31				1.09
16			0.03									0.03
17			0.58									
18										0.23		
19										0.19		
20										0.32		
21		1.18										
22					0.30							
23					1.10			0.05				
24												
25							0.08					
26				0.15								
27				0.18								
28				0.02	0.10							
29												
30		0.21	0.04						0.05			
31												
Totals	0.00	2.13	4.80	1.02	1.50	0.42	0.33	1.12	0.11	0.80	0.00	1.12
										Water Year Total:		13.35

NOTE: All Values are in units of inches, unless otherwise specified.

LEGEND: A - Acculated Total
 E - Estimated
 T - Trace, unmeasurable amount of rain

Data Revised: April 2016
A - 10

PRECIPITATION

DAILY RAINFALL SUMMARY

96C **Puddingstone Dam**

Gage Type: Standard Gage

Observation Time: Figures are for a 24-hour period

Latitude 34-05-31

Longitude: 117-48-24

Elevation: 1030 Feet

Water Year from 10/01/2014 to 09/30/2015

Day	Oct	Nov	Dec	Jan	Feb	Mar	Apr	May	Jun	Jul	Aug	Sep
1		0.47	0.38			0.11				T		
2		0.09	0.02			0.22						
3			1.76			T						
4			0.49									
5												
6												
7								T				
8					T		0.36	0.54				
9								T	T			
10												
11				0.65					T			
12			1.00	0.31								
13			0.28						0.05			
14												
15								0.63				0.65
16			T					0.08				0.76
17			0.42									
18										T		
19										0.42		
20										0.28		
21		T										
22								T				
23					0.71			T				
24					0.04							
25												
26							0.15					
27				0.23								
28					0.08							
29												
30			T	T								
31			0.12									
Totals	0.00	0.56	4.47	1.19	0.83	0.33	0.51	1.25	0.05	0.70	0.00	1.41
											Water Year Total:	11.30

NOTE: All Values are in units of inches, unless otherwise specified.

LEGEND: A - Acculated Total

 E - Estimated

 T - Trace, unmeasurable amount of rain

Data Revised: April 2016

A - 11

PRECIPITATION

DAILY RAINFALL SUMMARY

106F Whittier City Yard

Gage Type: Standard Gage

Observation Time: Figures are for a 24-hour period

Latitude 33-58-57

Longitude: 118-02-50

Elevation: 300 Feet

Water Year from 10/01/2014 to 09/30/2015

Day	Oct	Nov	Dec	Jan	Feb	Mar	Apr	May	Jun	Jul	Aug	Sep
1		0.08	0.59									
2		0.12				0.21						
3			0.94									
4			0.11									
5			0.01									
6												
7								0.35				
8							0.13	0.27				
9										0.02E		
10								0.01				
11				0.66				0.01				
12			1.20	0.21								
13												
14								0.40				
15			0.04					0.16				0.75E
16			0.11									0.31E
17			0.35									
18												
19										0.40		
20		0.01								0.07		
21		0.01										
22												
23					0.48							
24												
25												0.01
26												
27				0.29								
28												
29												
30												
31												
Totals	0.00	0.22	3.35	1.16	0.48	0.21	0.13	1.20	0.02	0.47	0.00	1.07
												Water Year Total: 8.31

NOTE: All Values are in units of inches, unless otherwise specified.

LEGEND: A - Acculated Total
 E - Estimated
 T - Trace, unmeasurable amount of rain

Data Revised: April 2016
A - 12

PRECIPITATION

DAILY RAINFALL SUMMARY

109D West Arcadia

Gage Type: Standard Gage

Observation Time: Figures are for a 24-hour period

Latitude 34-07-42

Longitude: 118-04-22

Elevation: 547 Feet

Water Year from 10/01/2014 to 09/30/2015

Day	Oct	Nov	Dec	Jan	Feb	Mar	Apr	May	Jun	Jul	Aug	Sep
1		0.40				0.05						
2						0.26						
3			1.45									
4			0.40									
5												
6												
7												
8					0.05		0.20	0.25				
9												
10												
11				0.53					0.01			
12			0.96	0.06								
13			0.47									
14												
15								0.83				1.25
16			0.04					0.02				0.75
17			0.82									
18												
19										0.19		
20										0.13		
21												
22												
23					0.59							
24					0.20							
25												
26							0.25					
27				0.24								
28					0.03							
29												
30		0.30		0.02								
31			0.25									
Totals	0.00	0.70	4.39	0.85	0.87	0.31	0.45	1.10	0.01	0.32	0.00	2.00
											Water Year Total:	11.00

NOTE: All Values are in units of inches, unless otherwise specified.

LEGEND: A - Acculated Total
 E - Estimated
 T - Trace, unmeasurable amount of rain

Data Revised: April 2016
A - 13

PRECIPITATION

DAILY RAINFALL SUMMARY

125B San Francisquito Canyon Ph#1 - Saugus

Gage Type: Standard Gage

Observation Time: Figures are for a 24-hour period

Latitude 34-35-25

Longitude: 118-27-15

Elevation: 2105 Feet

Water Year from 10/01/2014 to 09/30/2015

Day	Oct	Nov	Dec	Jan	Feb	Mar	Apr	May	Jun	Jul	Aug	Sep
1		0.61	0.03			0.20				0.02		
2		0.09	0.80			0.11						
3			0.59			0.04						
4			0.12									
5			0.01									
6												
7					0.05		0.03					
8					0.07		0.20	0.24				
9					0.01							
10				0.03					0.02			
11				0.75								
12			2.07									
13												
14								0.02				
15								0.97				0.92
16			0.03									0.08
17			0.27									
18			0.02							0.13		
19										0.42		
20										0.80		
21										0.10		
22					0.26							
23					0.60							
24					0.01							
25							0.05					
26							0.12					
27				0.04								
28					0.03							
29												
30		0.15		0.01						0.05		
31												
Totals	0.00	0.85	3.94	0.83	1.03	0.35	0.40	1.23	0.02	1.52	0.00	1.00
										Water Year Total:		11.17

NOTE: All Values are in units of inches, unless otherwise specified.

LEGEND: A - Acculated Total
 E - Estimated
 T - Trace, unmeasurable amount of rain

Data Revised: April 2016
A - 14

PRECIPITATION

DAILY RAINFALL SUMMARY

134C Puddingstone Diversion

Gage Type: Standard Gage

Observation Time: Figures are for a 24-hour period

Latitude 34-07-52

Longitude: 117-46-55

Elevation: 1160 Feet

Water Year from 10/01/2014 to 09/30/2015

Day	Oct	Nov	Dec	Jan	Feb	Mar	Apr	May	Jun	Jul	Aug	Sep
1		A	0.26			A						
2		0.39A				0.51A						
3			1.50									
4			0.53									
5								T				
6												
7												
8							0.37	0.39				
9					0.02							
10												
11				A								
12			0.68	0.84A								
13			0.50							A		
14									0.31A			
15								0.61				0.62
16			0.03					0.03				0.57
17			0.77									
18												
19										A		
20										0.79A		
21		0.37										
22												
23					0.83			0.07				
24					0.27							
25												
26								0.12				
27				0.22								
28						A						
29												
30												
31			0.20									
Totals	0.00	0.76	4.47	1.06	1.12	0.51	0.49	1.10	0.31	0.79	0.00	1.19
										Water Year Total:		11.80

NOTE: All Values are in units of inches, unless otherwise specified.

LEGEND: A - Acculated Total

E - Estimated

T - Trace, unmeasurable amount of rain

Data Revised: April 2016

A - 15

PRECIPITATION

DAILY RAINFALL SUMMARY

144 Sierra Madre Dam

Gage Type: Standard Gage

Observation Time: Figures are for a 24-hour period

Latitude 34-10-34

Longitude: 118-02-32

Elevation: 1100 Feet

Water Year from 10/01/2014 to 09/30/2015

Day	Oct	Nov	Dec	Jan	Feb	Mar	Apr	May	Jun	Jul	Aug	Sep
1		0.56	0.32			0.08						
2			0.01			0.27						
3			1.72			0.10						
4			0.61									
5												
6												
7												
8					0.11		0.45	0.15				
9												
10												
11				0.72								
12			1.40	0.18								
13			0.86						0.05			
14												
15								1.10				1.38
16								0.02				0.94
17			0.80									
18			0.02									
19										0.23		
20										1.25		
21		0.05										
22												
23					1.01							
24					0.30							
25												
26							0.19					
27				0.10								
28					0.08							
29												
30				0.01								
31			0.19									
Totals	0.00	0.61	5.93	1.01	1.50	0.45	0.64	1.27	0.05	1.48	0.00	2.32
										Water Year Total:		15.26

NOTE: All Values are in units of inches, unless otherwise specified.

LEGEND: A - Acculated Total
 E - Estimated
 T - Trace, unmeasurable amount of rain

Data Revised: April 2016
A - 16

PRECIPITATION

DAILY RAINFALL SUMMARY

167C Arcadia Pumping Plant #1

Gage Type: Standard Gage

Observation Time: Figures are for a 24-hour period

Latitude 34-09-31

Longitude: 118-02-02

Elevation: 611 Feet

Water Year from 10/01/2014 to 09/30/2015

Day	Oct	Nov	Dec	Jan	Feb	Mar	Apr	May	Jun	Jul	Aug	Sep
1		0.49	0.05			A						
2			1.40			0.32A						
3			0.46									
4			0.20						0.01E			
5												
6												
7								0.25				
8					0.10E		0.25					
9												
10				0.20								
11				0.55								
12			1.95									
13									0.01E			
14								0.50				
15								0.24				1.64
16			0.40									
17			0.19									
18										0.02E		
19										0.28E		
20										0.60E		
21												
22					0.40							
23					0.78							
24												
25								0.10E				
26								0.06E				
27				0.10E								
28					0.12							
29												
30		0.23	0.18									
31												
Totals	0.00	0.72	4.83	0.85	1.40	0.32	0.41	0.99	0.02	0.90	0.00	1.64
										Water Year Total:		12.08

NOTE: All Values are in units of inches, unless otherwise specified.

LEGEND: A - Acculated Total

E - Estimated

T - Trace, unmeasurable amount of rain

Data Revised: April 2016

A - 17

PRECIPITATION

DAILY RAINFALL SUMMARY

169 **Sierra Madre Pumping Plant**

Gage Type: Standard Gage

Observation Time: Figures are for a 24-hour period

Latitude 34-09-47

Longitude: 118-02-21

Elevation: 700 Feet

Water Year from 10/01/2014 to 09/30/2015

Day	Oct	Nov	Dec	Jan	Feb	Mar	Apr	May	Jun	Jul	Aug	Sep
1		0.52	0.33			0.06						
2						0.31						
3			1.64			0.05						
4			0.49									
5												
6												
7												
8					0.11		0.32	0.19				
9												
10												
11				0.67								
12			2.05	0.17								
13			0.63						0.04			
14												
15								0.87				1.17
16								0.01				0.76
17			0.67									
18			0.02									
19										0.30		
20										0.59		
21		0.05										
22												
23					0.89							
24					0.40							
25												
26							0.14					
27				0.10								
28					0.05							
29				0.01								
30												
31			0.16									
Totals	0.00	0.57	5.99	0.95	1.45	0.42	0.46	1.07	0.04	0.89	0.00	1.93
										Water Year Total:		13.77

NOTE: All Values are in units of inches, unless otherwise specified.

LEGEND: A - Acculated Total
 E - Estimated
 T - Trace, unmeasurable amount of rain

Data Revised: April 2016
A - 18

PRECIPITATION

DAILY RAINFALL SUMMARY

170F Potrero Heights

Gage Type: Standard Private

Observation Time: Figures are for a 24-hour period

Latitude 34-02-32

Longitude: 118-04-44

Elevation: 285 Feet

Water Year from 10/01/2014 to 09/30/2015

Day	Oct	Nov	Dec	Jan	Feb	Mar	Apr	May	Jun	Jul	Aug	Sep
1		0.65	0.03			0.05						
2			1.22			0.70						
3			0.53									
4			0.22									
5			T									
6												
7							0.08					
8								0.65				
9										T		
10				0.07								
11				0.56								
12			1.50									
13												
14												
15								0.57				1.47
16			0.05									
17			0.35					0.07				
18										0.12		
19										T		
20												
21		0.01										
22					0.16							
23					0.33							
24												
25								0.04				
26				0.14								
27												
28												
29												
30		0.35	0.25							T	T	
31												
Totals	0.00	1.01	4.15	0.77	0.49	0.75	0.12	1.29	0.00	0.12	0.00	1.47
												Water Year Total: 10.17

NOTE: All Values are in units of inches, unless otherwise specified.

LEGEND: A - Acculated Total
 E - Estimated
 T - Trace, unmeasurable amount of rain

PRECIPITATION

DAILY RAINFALL SUMMARY

175B La Canada Irrigation District

Gage Type: Standard Gage

Observation Time: Figures are for a 24-hour period

Latitude 34-13-39

Longitude: 118-12-40

Elevation: 2020 Feet

Water Year from 10/01/2014 to 09/30/2015

Day	Oct	Nov	Dec	Jan	Feb	Mar	Apr	May	Jun	Jul	Aug	Sep
1		0.83	0.53			0.31						
2			0.06			0.58						
3			1.70			0.15						
4			0.25									
5									0.16			
6												
7												
8					0.10		0.13	0.21				
9												
10												
11				0.86								
12			2.00	0.05								
13			0.44									
14												
15								1.07				1.73
16			0.05					0.02				0.44
17			1.04									
18												
19										0.68		
20										1.45		
21												
22												
23					1.17							
24					0.17							
25												
26							0.22					
27				0.11								
28					0.03							
29												
30				0.02						T		
31	T											
Totals	0.00	0.83	6.07	1.04	1.47	1.04	0.35	1.30	0.16	2.13	0.00	2.17
										Water Year Total:		16.56

NOTE: All Values are in units of inches, unless otherwise specified.

LEGEND: A - Acculated Total
 E - Estimated
 T - Trace, unmeasurable amount of rain

Data Revised: April 2016
 A - 20

PRECIPITATION

DAILY RAINFALL SUMMARY

176 Altadena-Rubio Canyon

Gage Type: Standard Gage

Observation Time: Figures are for a 24-hour period

Latitude 34-10-55

Longitude: 118-08-15

Elevation: 1125 Feet

Water Year from 10/01/2014 to 09/30/2015

Day	Oct	Nov	Dec	Jan	Feb	Mar	Apr	May	Jun	Jul	Aug	Sep
1		0.62	0.23			0.13						
2						0.35						
3			1.46			0.08						
4			0.32									
5									0.06			
6												
7												
8					0.06		0.23	0.11				
9												
10										T		
11				0.62								
12			1.72	0.10								
13			0.76									
14												
15								1.64				1.53
16			0.05					0.04				0.85
17			0.90									
18												
19										0.49		
20										0.43		
21												
22												
23					0.81							
24					0.42							
25												
26							0.12					
27				0.14								
28					0.06							
29												
30				0.01								
31			0.03	0.03								
Totals	0.00	0.62	5.47	0.90	1.35	0.56	0.35	1.79	0.06	0.92	0.00	2.38
										Water Year Total:		14.40

NOTE: All Values are in units of inches, unless otherwise specified.

LEGEND: A - Acculated Total

E - Estimated

T - Trace, unmeasurable amount of rain

Data Revised: April 2016

A - 21

PRECIPITATION

DAILY RAINFALL SUMMARY

196C La Verne-Fire Station

Gage Type: Standard Gage

Observation Time: Figures are for a 24-hour period

Latitude 34-06-06

Longitude: 117-46-20

Elevation: 1050 Feet

Water Year from 10/01/2014 to 09/30/2015

Day	Oct	Nov	Dec	Jan	Feb	Mar	Apr	May	Jun	Jul	Aug	Sep
1		0.57	0.26E			0.09				0.01		
2			0.01E			0.19E						
3			1.35E									
4			0.60									
5												
6												
7												
8							0.31	0.50E				
9												
10												
11				0.50								
12			1.00	0.30								
13			0.30						0.10			
14												
15								0.55				0.76E
16								0.25				0.66E
17			0.45									
18												
19										0.45		
20										0.50		
21		0.05				0.01						
22												
23						0.78E						
24						0.10						
25												
26								0.14E				
27				0.26E								
28						0.10						
29												
30												
31			0.13									
Totals	0.00	0.62	4.10	1.06	0.99	0.28	0.45	1.30	0.10	0.96	0.00	1.42
											Water Year Total:	11.28

NOTE: All Values are in units of inches, unless otherwise specified.

LEGEND: A - Acculated Total
 E - Estimated
 T - Trace, unmeasurable amount of rain

Data Revised: April 2016
A - 22

PRECIPITATION

DAILY RAINFALL SUMMARY

216C **Glendale - Jackson**

Gage Type: Standard Private

Observation Time: Figures are for a 24-hour period

Latitude 34-09-54

Longitude: 118-15-01

Elevation: 615 Feet

Water Year from 10/01/2014 to 09/30/2015

Day	Oct	Nov	Dec	Jan	Feb	Mar	Apr	May	Jun	Jul	Aug	Sep
1		0.47										
2			1.17			0.69						
3			0.14									
4			0.06									
5												
6												
7					0.05							
8								0.01				
9												
10				0.09								
11				0.60								
12			2.07									
13												
14								0.21				
15								0.35				1.77
16			0.28									0.02
17			0.55									
18			0.06							0.35		
19										0.10		
20										0.30		
21												
22					0.17							
23					0.23							
24												
25							0.16				T	
26				0.13								
27												
28												
29												
30		0.25		0.62								
31	0.08											
Totals	0.08	0.72	4.33	1.44	0.45	0.69	0.16	0.57	0.00	0.75	0.00	1.79
										Water Year Total:		10.98

NOTE: All Values are in units of inches, unless otherwise specified.

LEGEND: A - Acculated Total

 E - Estimated

 T - Trace, unmeasurable amount of rain

Data Revised: April 2016

A - 23

PRECIPITATION

DAILY RAINFALL SUMMARY

223C **Big Dalton Dam**

Gage Type: Standard Gage

Observation Time: Figures are for a 24-hour period

Latitude 34-10-06

Longitude: 117-48-36

Elevation: 1587 Feet

Water Year from 10/01/2014 to 09/30/2015

Day	Oct	Nov	Dec	Jan	Feb	Mar	Apr	May	Jun	Jul	Aug	Sep
1		0.69	0.46			0.30						
2		0.11				0.26						
3			1.84			0.15			T			
4			0.54									
5									0.02			
6												
7											0.02	
8					0.06		0.50	0.26				
9				T				0.01				
10									T			
11		T		0.54					0.01			
12			1.60	0.37					T			
13			0.50						0.09			
14									T			
15								0.58				0.60
16			T					0.02				0.80
17			1.23									
18												
19						0.01				0.42		
20										0.36		
21		0.08										
22							0.02					
23					1.19			0.08				
24					0.54							
25												
26							0.11					
27				0.37								
28					0.12							
29												
30				0.03								
31			0.18									
Totals	0.00	0.88	6.35	1.31	1.91	0.72	0.63	0.95	0.12	0.78	0.02	1.40
											Water Year Total:	15.07

NOTE: All Values are in units of inches, unless otherwise specified.

LEGEND: A - Acculated Total

 E - Estimated

 T - Trace, unmeasurable amount of rain

Data Revised: April 2016

A - 24

PRECIPITATION

DAILY RAINFALL SUMMARY

225 **Montana Ranch-Lakewood**

Gage Type: Standard Gage

Observation Time: Figures are for a 24-hour period

Latitude 33-50-35

Longitude: 118-07-09

Elevation: 47 Feet

Water Year from 10/01/2014 to 09/30/2015

Day	Oct	Nov	Dec	Jan	Feb	Mar	Apr	May	Jun	Jul	Aug	Sep
1		0.05	0.47			0.37						
2			0.02			0.13						
3			1.26									
4			0.81									
5			0.02									
6								0.03				
7							0.21	0.30				
8												
9												
10			T									
11			1.01	0.94								
12			0.45	0.02								
13												
14		T						0.38				0.74
15			0.10					0.11				0.11
16			0.60									
17			0.02									
18										0.50		
19										0.28		
20												
21												
22					0.44							
23												
24												
25												
26				0.13			0.03				0.01	
27												
28						T						
29												
30		0.23	0.03	0.02								
31	0.30											
Totals	0.30	0.28	4.79	1.11	0.44	0.50	0.24	0.82	0.00	0.78	0.01	0.85
										Water Year Total:		10.12

NOTE: All Values are in units of inches, unless otherwise specified.

LEGEND: A - Acculated Total

 E - Estimated

 T - Trace, unmeasurable amount of rain

Data Revised: April 2016

A - 25

PRECIPITATION

DAILY RAINFALL SUMMARY

228C Beverly Hills City Hall

Gage Type: Standard Gage

Observation Time: Figures are for a 24-hour period

Latitude 34-06-00

Longitude: 118-23-40

Elevation: 245 Feet

Water Year from 10/01/2014 to 09/30/2015

Day	Oct	Nov	Dec	Jan	Feb	Mar	Apr	May	Jun	Jul	Aug	Sep
1		0.40	0.02			0.15						
2			1.40			0.04						
3												
4												
5												
6												
7												
8							0.26E					
9												
10												
11				1.15								
12			1.37									
13			0.11									
14								0.67				2.00
15												
16			0.51									
17												
18										0.25		
19										0.03		
20												
21												
22						0.35						
23						T						
24												
25												
26				0.05								
27												
28												
29												
30			0.19	0.05								
31												
Totals	0.00	0.40	3.60	1.25	0.35	0.19	0.26	0.67	0.00	0.28	0.00	2.00
												Water Year Total: 9.00

NOTE: All Values are in units of inches, unless otherwise specified.

LEGEND: A - Acculated Total
 E - Estimated
 T - Trace, unmeasurable amount of rain

PRECIPITATION

DAILY RAINFALL SUMMARY

235C Henniger Flats

Gage Type: Standard Gage

Observation Time: Figures are for a 24-hour period

Latitude 34-11-38

Longitude: 118-05-17

Elevation: 2550 Feet

Water Year from 10/01/2014 to 09/30/2015

Day	Oct	Nov	Dec	Jan	Feb	Mar	Apr	May	Jun	Jul	Aug	Sep
1		0.89	0.01			0.05	0.01					
2			1.35			0.30						
3			0.70			0.05			0.05			
4									0.10			
5												
6												
7								0.01				
8					0.12		0.36	0.33				
9										0.02		
10												
11				0.92					0.07			
12			2.61	0.07					0.02			
13												
14								1.00				
15								1.08				2.03
16			0.40									0.40
17			0.02									
18						0.15				0.23		
19										0.13		
20										1.27		
21		0.13										
22					0.35					0.03		
23					1.32					0.04		
24								0.02				
25								0.16				
26								0.09				
27				0.10								
28					0.23							
29		0.18										
30		0.39										
31			0.08									
Totals	0.00	1.59	5.17	1.09	2.02	0.55	0.64	2.42	0.24	1.72	0.00	2.43
										Water Year Total:		17.87

NOTE: All Values are in units of inches, unless otherwise specified.

LEGEND: A - Acculated Total
 E - Estimated
 T - Trace, unmeasurable amount of rain

Data Revised: April 2016
A - 27

PRECIPITATION

DAILY RAINFALL SUMMARY

251C La Crescenta

Gage Type: Standard Gage

Observation Time: Figures are for a 24-hour period

Latitude 34-13-20

Longitude: 118-14-40

Elevation: 1440 Feet

Water Year from 10/01/2014 to 09/30/2015

Day	Oct	Nov	Dec	Jan	Feb	Mar	Apr	May	Jun	Jul	Aug	Sep
1		A			T	0.61						
2		0.73A	1.28			0.15						
3			0.32			T						
4			0.11						0.02			
5									0.01			
6								T				
7					A		T					
8					0.05A		0.11	0.11				
9												
10				A					T			
11				0.85A					0.01			
12			2.41									
13			T									
14								0.27				
15								0.55				1.94
16			0.32									0.06
17			0.94									
18												
19						T				A		
20										1.58A		
21		T										
22					0.79							
23					0.08							
24									T			
25							0.24				T	
26												
27				0.08								
28												
29												
30		0.65	T	0.01								
31												
Totals	0.00	1.38	5.38	0.94	0.92	0.76	0.35	0.93	0.04	1.58	0.00	2.00
										Water Year Total:		14.28

NOTE: All Values are in units of inches, unless otherwise specified.

LEGEND: A - Acculated Total

E - Estimated

T - Trace, unmeasurable amount of rain

Data Revised: April 2016

A - 28

PRECIPITATION

DAILY RAINFALL SUMMARY

252C Castaic Lake

Gage Type: Standard Gage

Observation Time: Figures are for a 24-hour period

Latitude 34-29-53

Longitude: 118-36-53

Elevation: 1150 Feet

Water Year from 10/01/2014 to 09/30/2015

Day	Oct	Nov	Dec	Jan	Feb	Mar	Apr	May	Jun	Jul	Aug	Sep
1		0.41	0.18			0.08						
2		0.01	0.20			0.37						
3			1.60			0.03						
4			0.12									
5												
6												
7			0.01									
8					0.10		0.19	0.03				
9								0.01				
10										T		
11				1.21								
12			1.54									
13			0.24									
14			0.01									0.02
15								0.91				0.90
16			0.06					0.03				0.06
17			0.25									
18												
19										0.52		
20										0.24		
21												
22					0.02							
23					0.42							
24					0.11							
25												
26							0.05					
27				0.04								
28												
29												
30		T										
31												
Totals	0.00	0.42	4.21	1.25	0.65	0.48	0.24	0.98	0.00	0.76	0.00	0.98
										Water Year Total:		9.97

NOTE: All Values are in units of inches, unless otherwise specified.

LEGEND: A - Acculated Total

E - Estimated

T - Trace, unmeasurable amount of rain

Data Revised: April 2016

A - 29

PRECIPITATION

DAILY RAINFALL SUMMARY

287B **Glendora-City Hall**

Gage Type: Standard Gage

Observation Time: Figures are for a 24-hour period

Latitude 34-08-09

Longitude: 117-51-52

Elevation: 785 Feet

Water Year from 10/01/2014 to 09/30/2015

Day	Oct	Nov	Dec	Jan	Feb	Mar	Apr	May	Jun	Jul	Aug	Sep
1		0.84	0.22			A						
2		T				0.28A						
3			1.57			0.20						
4			0.32									
5												
6												
7					0.03							
8							0.34	0.20				
9												
10												
11				A					0.02			
12			A	0.63A								
13			1.47A						0.06			
14												
15								0.42				0.90
16												0.70
17			0.85									
18										0.08		
19										0.38E		
20										0.68E		
21		1.31										
22												
23					1.15							
24					1.05							
25												
26							0.09					
27				0.28								
28												
29										0.02		
30												
31			0.35									
Totals	0.00	2.15	4.78	0.91	2.23	0.48	0.43	0.62	0.08	1.16	0.00	1.60
										Water Year Total:		14.44

NOTE: All Values are in units of inches, unless otherwise specified.

LEGEND: A - Acculated Total

 E - Estimated

 T - Trace, unmeasurable amount of rain

Data Revised: April 2016

A - 30

PRECIPITATION

DAILY RAINFALL SUMMARY

294B Sierra Madre-Mira Monte Pumping Plant

Gage Type: Standard Gage

Observation Time: Figures are for a 24-hour period

Latitude 34-10-11

Longitude: 118-02-51

Elevation: 985 Feet

Water Year from 10/01/2014 to 09/30/2015

Day	Oct	Nov	Dec	Jan	Feb	Mar	Apr	May	Jun	Jul	Aug	Sep
1		0.62	0.29			0.06						
2			0.01			0.28						
3			1.74			0.07						
4			0.59									
5												
6												
7												
8					0.09		0.38	0.16				
9												
10												
11				0.68								
12			1.45	0.19								
13			0.96						0.02			
14												
15								0.91				1.38
16								0.01				0.88
17			0.73									
18			0.02									
19										0.23		
20										0.86		
21		0.05										
22												
23					0.95							
24					0.38							
25												
26							0.17					
27				0.10								
28					0.09							
29												
30				0.01								
31			0.20									
Totals	0.00	0.67	5.99	0.98	1.51	0.41	0.55	1.08	0.02	1.09	0.00	2.26
										Water Year Total:		14.56

NOTE: All Values are in units of inches, unless otherwise specified.

LEGEND: A - Acculated Total
 E - Estimated
 T - Trace, unmeasurable amount of rain

PRECIPITATION

DAILY RAINFALL SUMMARY

306H Zuma Beach

Gage Type: Standard Gage

Observation Time: Figures are for a 24-hour period

Latitude 34-01-15

Longitude: 118-49-42

Elevation: 15 Feet

Water Year from 10/01/2014 to 09/30/2015

Day	Oct	Nov	Dec	Jan	Feb	Mar	Apr	May	Jun	Jul	Aug	Sep
1		0.42										
2			0.92			0.86				0.03		
3			0.22			0.14						
4												
5												
6												
7					0.04		0.16					
8								0.17				
9									0.10			
10				0.37E					0.01			
11			T	0.99E								
12			1.13									
13												
14								0.03				
15								0.60				0.67
16			0.22									
17			0.26									
18										0.90		
19										0.24		
20												
21												
22					0.02							
23					0.12							
24												
25												
26				0.02								
27				0.09								
28												
29												
30		0.83										
31												
Totals	0.00	1.25	2.75	1.47	0.18	1.00	0.16	0.80	0.11	1.17	0.00	0.67
										Water Year Total:		9.56

NOTE: All Values are in units of inches, unless otherwise specified.

LEGEND: A - Acculated Total
 E - Estimated
 T - Trace, unmeasurable amount of rain

PRECIPITATION

DAILY RAINFALL SUMMARY

322 **Munz Valley Ranch**

Gage Type: Standard Private

Observation Time: Figures are for a 24-hour period

Latitude 34-42-50

Longitude: 118-21-15

Elevation: 2600 Feet

Water Year from 10/01/2014 to 09/30/2015

Day	Oct	Nov	Dec	Jan	Feb	Mar	Apr	May	Jun	Jul	Aug	Sep
1		0.63	0.02			0.17						
2			1.47			0.01						
3			0.54									
4			0.11									
5												
6												
7								0.10				
8												
9												
10				0.04								
11				1.33								
12			1.51						0.22			
13			0.20									
14								0.08				
15								0.17				0.23
16												
17			0.22									
18										0.42		
19										0.28		
20										0.16		
21												
22						0.10						
23						0.35						
24												
25								0.02				
26												
27				0.14								
28												
29				0.03								
30												
31												
Totals	0.00	0.63	4.07	1.54	0.45	0.18	0.02	0.35	0.22	0.86	0.00	0.23
												Water Year Total: 8.55

NOTE: All Values are in units of inches, unless otherwise specified.

LEGEND: A - Acculated Total
 E - Estimated
 T - Trace, unmeasurable amount of rain

Data Revised: April 2016
A - 33

PRECIPITATION

DAILY RAINFALL SUMMARY

334B Cogswell Dam

Gage Type: Standard Gage

Observation Time: Figures are for a 24-hour period

Latitude 34-14-37

Longitude: 117-57-35

Elevation: 2300 Feet

Water Year from 10/01/2014 to 09/30/2015

Day	Oct	Nov	Dec	Jan	Feb	Mar	Apr	May	Jun	Jul	Aug	Sep
1		0.98	0.36			0.22						
2		0.07	0.02			0.39						
3			3.76			0.26						
4			0.56									
5											T	
6												
7									T			
8					0.10		0.33	0.33				
9									T			
10									0.04			
11				1.64					T			
12			2.58	0.24		T						
13			1.87						0.02			
14												
15			T					1.73				1.23
16			0.04									1.06
17			1.23									
18												
19						0.05				0.54		
20										1.98		
21		0.07										
22												
23					1.53							
24					0.51							
25												
26							0.06					
27				0.33								
28					0.03							
29												
30				0.02								
31			0.06									
Totals	0.00	1.12	10.48	2.23	2.17	0.92	0.39	2.06	0.06	2.52	0.00	2.29
										Water Year Total:		24.24

NOTE: All Values are in units of inches, unless otherwise specified.

LEGEND: A - Acculated Total

E - Estimated

T - Trace, unmeasurable amount of rain

Data Revised: April 2016

PRECIPITATION

DAILY RAINFALL SUMMARY

338C Mt. Wilson-Observatory

Gage Type: Standard Gage

Observation Time: Figures are for a 24-hour period

Latitude 34-14-07

Longitude: 118-04-28

Elevation: 5709 Feet

Water Year from 10/01/2014 to 09/30/2015

Day	Oct	Nov	Dec	Jan	Feb	Mar	Apr	May	Jun	Jul	Aug	Sep
1		0.59				0.15						
2			2.93			0.57						
3			1.15									
4												
5												
6											0.01	
7					0.36			0.52				
8							0.18	0.06				
9									0.12			
10				1.49								
11			0.19	1.13		T						
12			4.14									
13												
14								1.84				0.06
15												3.34
16			1.19									0.11
17												
18						0.18				0.65		
19		T								2.58		
20										0.28		
21		0.03										
22		0.03			2.20			0.01				
23					0.66							
24												
25												
26				0.19			0.11					
27												
28					0.21							
29												
30		0.97	0.07	0.03					0.01	0.07		
31	0.82		0.03									
Totals	0.82	1.62	9.70	2.84	3.43	0.90	0.29	2.43	0.13	3.58	0.01	3.51
										Water Year Total:		29.26

NOTE: All Values are in units of inches, unless otherwise specified.

LEGEND: A - Acculated Total
 E - Estimated
 T - Trace, unmeasurable amount of rain

Data Revised: April 2016
A - 35

PRECIPITATION

DAILY RAINFALL SUMMARY

372 San Francisquito Power House No.2

Gage Type: Standard Gage

Observation Time: Figures are for a 24-hour period

Latitude 34-32-02

Longitude: 118-31-27

Elevation: 1580 Feet

Water Year from 10/01/2014 to 09/30/2015

Day	Oct	Nov	Dec	Jan	Feb	Mar	Apr	May	Jun	Jul	Aug	Sep
1		0.63	0.05			0.29						
2		0.04	1.11			0.34						
3			0.70			0.03						
4			0.21									
5			0.06									
6												
7					0.06		0.01					
8					0.10		0.23	0.02				
9												
10				0.10								
11				0.80								
12			2.10	0.10								
13												
14								0.18				
15								0.85				1.10
16			0.04									
17			0.31									
18										0.40		
19										0.42		
20										0.24		
21										0.01		
22					0.37							
23					0.53							
24					0.05							
25												
26							0.10					
27				0.08								
28												
29												
30		0.31										
31										0.40		
Totals	0.00	0.98	4.58	1.08	1.11	0.66	0.34	1.05	0.00	1.47	0.00	1.10
										Water Year Total:		12.37

NOTE: All Values are in units of inches, unless otherwise specified.

LEGEND: A - Acculated Total
 E - Estimated
 T - Trace, unmeasurable amount of rain

Data Revised: April 2016
A - 36

PRECIPITATION

DAILY RAINFALL SUMMARY

373C Briggs Terrace

Gage Type: Standard Private

Observation Time: Figures are for a 24-hour period

Latitude 34-14-17

Longitude: 118-13-27

Elevation: 2200 Feet

Water Year from 10/01/2014 to 09/30/2015

Day	Oct	Nov	Dec	Jan	Feb	Mar	Apr	May	Jun	Jul	Aug	Sep
1		0.82				0.29						
2			1.54			0.80						
3			0.38						0.02			
4			0.05						0.17			
5												
6												
7					0.12							
8					0.05		0.16	0.28				
9									0.03	0.04		
10												
11				1.00								
12			2.90	0.04					0.03			
13												
14								0.23				
15								0.51				2.14
16			0.89					0.03				0.35
17												
18										0.81		
19										1.51		
20							0.03			0.04		
21												
22						0.77				0.02		
23						0.44						
24												
25								0.25				
26												
27				0.13								
28					0.05							
29												
30		0.62	0.02									
31				0.10								
Totals	0.00	1.44	5.78	1.27	1.43	1.09	0.44	1.05	0.25	2.42	0.00	2.49
											Water Year Total:	17.66

NOTE: All Values are in units of inches, unless otherwise specified.

LEGEND: A - Acculated Total
 E - Estimated
 T - Trace, unmeasurable amount of rain

Data Revised: April 2016
A - 37

PRECIPITATION

DAILY RAINFALL SUMMARY

387B Covina City Yard

Gage Type: Standard Gage

Observation Time: Figures are for a 24-hour period

Latitude 34-05-02

Longitude: 117-53-57

Elevation: 508 Feet

Water Year from 10/01/2014 to 09/30/2015

Day	Oct	Nov	Dec	Jan	Feb	Mar	Apr	May	Jun	Jul	Aug	Sep
1		0.31	0.48			0.10						
2						0.15						
3			1.50									
4			0.40									
5						0.10						
6												
7												
8							0.25	0.40				
9												
10												
11				0.36								
12			1.20	0.23								
13			0.25									
14												
15								0.55				0.67
16												0.40
17			0.54									
18												
19										0.31		
20										0.47		
21												
22												
23						0.59E						
24						0.01E						
25												
26								0.25				
27				0.17								
28						0.08						
29												
30												
31			0.02									
Totals	0.00	0.31	4.39	0.76	0.68	0.35	0.50	0.95	0.00	0.78	0.00	1.07
										Water Year Total:		9.79

NOTE: All Values are in units of inches, unless otherwise specified.

LEGEND: A - Acculated Total
 E - Estimated
 T - Trace, unmeasurable amount of rain

PRECIPITATION

DAILY RAINFALL SUMMARY

390B **Morris Dam**

Gage Type: Standard Gage

Observation Time: Figures are for a 24-hour period

Latitude 34-10-53

Longitude: 117-52-43

Elevation: 1210 Feet

Water Year from 10/01/2014 to 09/30/2015

Day	Oct	Nov	Dec	Jan	Feb	Mar	Apr	May	Jun	Jul	Aug	Sep
1		0.74	0.50			0.26						
2		0.11	0.03			0.10						
3			1.73			0.26						
4			0.44							T		
5									0.04			
6												
7											0.02	
8					0.07		0.51	0.24				
9									T			
10												0.02
11				0.57					0.01			
12			1.34	0.34								
13			0.80						T			
14								0.02				
15								0.71				0.98
16			T					0.01				0.71
17			0.91									
18												
19						0.02				0.32		
20										0.32		
21		0.54										
22					0.01							
23					1.14			0.10				
24					0.38							
25							0.01					
26							0.10					
27				0.39								
28					0.12							
29												
30				T								
31			0.17									
Totals	0.00	1.39	5.92	1.30	1.72	0.64	0.62	1.08	0.05	0.64	0.02	1.71
										Water Year Total:		15.09

NOTE: All Values are in units of inches, unless otherwise specified.

LEGEND: A - Acculated Total

 E - Estimated

 T - Trace, unmeasurable amount of rain

Data Revised: April 2016

A - 39

PRECIPITATION

DAILY RAINFALL SUMMARY

405B Soledad Canyon

Gage Type: Standard Private

Observation Time: Figures are for a 24-hour period

Latitude 34-26-23

Longitude: 118-17-33

Elevation: 2150 Feet

Water Year from 10/01/2014 to 09/30/2015

Day	Oct	Nov	Dec	Jan	Feb	Mar	Apr	May	Jun	Jul	Aug	Sep
1		0.49										
2		0.03	1.42			0.15						
3			0.19									
4												
5												
6												
7					0.05							
8								0.14				
9						0.01			0.05			0.12
10				0.08								
11				0.65								
12			2.08									
13												
14								0.62				
15												0.45
16			0.08									0.06
17			0.35									
18										0.76		
19						0.04				0.24		
20												
21		0.20										
22						A						
23						0.65A						
24												
25								0.04				
26												
27				0.05								
28												
29												
30		0.10										
31												
Totals	0.00	0.82	4.12	0.78	0.70	0.20	0.04	0.76	0.05	1.00	0.00	0.63
										Water Year Total:		9.10

NOTE: All Values are in units of inches, unless otherwise specified.

LEGEND: A - Acculated Total
 E - Estimated
 T - Trace, unmeasurable amount of rain

Data Revised: April 2016
A - 40

PRECIPITATION

DAILY RAINFALL SUMMARY

406C West Azusa

Gage Type: Standard Gage

Observation Time: Figures are for a 24-hour period

Latitude 34-06-53

Longitude: 117-54-56

Elevation: 505 Feet

Water Year from 10/01/2014 to 09/30/2015

Day	Oct	Nov	Dec	Jan	Feb	Mar	Apr	May	Jun	Jul	Aug	Sep
1		0.70	0.32E			0.32						
2			E			0.24						
3			1.55E									
4			0.41E									
5												
6												
7												
8							0.19	0.26E				
9												
10												0.17
11				0.43E								
12			1.37E	0.13								
13			0.14									
14												
15								0.60E				0.90
16												0.56
17			0.52									
18												
19										A		
20										1.18A		
21		0.01										
22												
23					0.89							
24					0.33							
25												
26							0.19					
27				0.18								
28												
29												
30												
31			0.27									
Totals	0.00	0.71	4.58	0.74	1.22	0.56	0.38	0.86	0.00	1.18	0.00	1.63
										Water Year Total:		11.86

NOTE: All Values are in units of inches, unless otherwise specified.

LEGEND: A - Acculated Total

E - Estimated

T - Trace, unmeasurable amount of rain

Data Revised: April 2016

A - 41

PRECIPITATION

DAILY RAINFALL SUMMARY

409B Pyramid Reservoir

Gage Type: Standard Gage

Observation Time: Figures are for a 24-hour period

Latitude 34-40-34

Longitude: 118-46-47

Elevation: 2505 Feet

Water Year from 10/01/2014 to 09/30/2015

Day	Oct	Nov	Dec	Jan	Feb	Mar	Apr	May	Jun	Jul	Aug	Sep
1		0.48	0.01			0.03						
2		T	0.88			0.46						
3			0.86			0.07						
4			0.01									
5												
6												
7												
8							0.01	0.08				
9								T				
10									0.02			0.79
11				1.19					0.18			
12			2.60	0.02								
13			0.20									
14												
15								0.04				0.47
16			0.09					0.01				0.01
17			0.08									
18			T									
19										0.82		
20										0.22		
21		0.02										
22					0.01			0.03				
23					0.09							
24					0.06			T				
25					T							
26							0.17					
27				0.51								
28				0.01								
29												
30		0.01		0.03								
31										1.29		
Totals	0.00	0.51	4.73	1.76	0.16	0.56	0.18	0.16	0.20	2.33	0.00	1.27
											Water Year Total:	11.86

NOTE: All Values are in units of inches, unless otherwise specified.

LEGEND: A - Acculated Total

E - Estimated

T - Trace, unmeasurable amount of rain

Data Revised: April 2016

A - 42

PRECIPITATION

DAILY RAINFALL SUMMARY

425B San Gabriel Dam

Gage Type: Standard Gage

Observation Time: Figures are for a 24-hour period

Latitude 34-12-19

Longitude: 117-51-38

Elevation: 1481 Feet

Water Year from 10/01/2014 to 09/30/2015

Day	Oct	Nov	Dec	Jan	Feb	Mar	Apr	May	Jun	Jul	Aug	Sep
1		0.84	0.47			0.51						
2		T	0.01			0.15						
3			2.39			0.37						
4			0.40									
5												
6												
7											0.03	
8					0.05		0.45	0.30				
9								T				
10												0.02
11				0.69								
12			1.74	0.33								
13			0.70						0.03			
14								0.01				
15								0.82				1.08
16			0.01					T				0.75
17			1.52									
18												
19						0.01				0.44		
20										0.24		
21		0.03										
22					0.01							
23					1.18			0.03				
24					0.72							
25												
26							0.04					
27				0.63								
28					0.19							
29												
30				0.02								
31			0.02									
Totals	0.00	0.87	7.26	1.67	2.15	1.04	0.49	1.16	0.03	0.68	0.03	1.85
										Water Year Total:		17.23

NOTE: All Values are in units of inches, unless otherwise specified.

LEGEND: A - Acculated Total
 E - Estimated
 T - Trace, unmeasurable amount of rain

Data Revised: April 2016
A - 43

PRECIPITATION

DAILY RAINFALL SUMMARY

436C Hansen Dam

Gage Type: Standard Gage

Observation Time: Figures are for a 24-hour period

Latitude 34-16-08

Longitude: 118-23-59

Elevation: 1110 Feet

Water Year from 10/01/2014 to 09/30/2015

Day	Oct	Nov	Dec	Jan	Feb	Mar	Apr	May	Jun	Jul	Aug	Sep
1		0.38	0.17			0.16						
2			1.23			0.40						
3			0.20									
4			0.01									
5												
6												
7					0.03		0.11					
8					0.01		0.01					
9												
10				0.05								
11				0.79								
12			2.01									
13												
14								0.34				
15								0.16				0.61
16			0.07									0.03
17			0.62									
18										0.53		
19										0.15		
20										0.13		
21												
22					0.13							
23					0.54							
24												
25							0.12					
26							0.01					
27				0.09								
28												
29												
30		0.52		0.33								
31												
Totals	0.00	0.90	4.31	1.26	0.71	0.56	0.25	0.50	0.00	0.81	0.00	0.64
												Water Year Total: 9.94

NOTE: All Values are in units of inches, unless otherwise specified.

LEGEND: A - Acculated Total
 E - Estimated
 T - Trace, unmeasurable amount of rain

Data Revised: April 2016
A - 44

PRECIPITATION

DAILY RAINFALL SUMMARY

445B Live Oak Dam

Gage Type: Standard Gage

Observation Time: Figures are for a 24-hour period

Latitude 34-08-02

Longitude: 117-44-38

Elevation: 1510 Feet

Water Year from 10/01/2014 to 09/30/2015

Day	Oct	Nov	Dec	Jan	Feb	Mar	Apr	May	Jun	Jul	Aug	Sep
1		0.50	0.29			0.10						
2		0.01	0.01			0.17						
3			1.17									
4			0.43									
5			0.01									
6												
7												
8							0.26	0.34				
9								T	T			
10												
11				0.52								
12			0.85	0.21								
13			0.14						0.04			
14												
15								0.62				0.68
16								0.08				0.22
17			0.62									
18												
19										0.26		
20										0.22		
21		0.60										
22												
23					0.67			0.05				
24					0.23							
25												
26							0.11					
27				0.18								
28					0.03							
29												
30												
31			0.12									
Totals	0.00	1.11	3.64	0.91	0.93	0.27	0.37	1.09	0.04	0.48	0.00	0.90
										Water Year Total:		9.74

NOTE: All Values are in units of inches, unless otherwise specified.

LEGEND: A - Acculated Total
 E - Estimated
 T - Trace, unmeasurable amount of rain

PRECIPITATION

DAILY RAINFALL SUMMARY

449B Eaton Wash Dam

Gage Type: Standard Gage

Observation Time: Figures are for a 24-hour period

Latitude 34-10-06

Longitude: 118-05-33

Elevation: 880 Feet

Water Year from 10/01/2014 to 09/30/2015

Day	Oct	Nov	Dec	Jan	Feb	Mar	Apr	May	Jun	Jul	Aug	Sep
1		A	0.20			A						
2		0.75A	0.01		0.01	0.45A						
3			1.32									
4			0.37									
5									0.02			
6												
7								0.01				
8					0.07		0.32	0.03				
9								0.08				
10									0.02			
11				A					0.03			
12			1.60	0.76A								
13			0.63									
14												
15								0.85				1.54
16			0.03									0.49
17			0.61									
18												
19						0.07				A		
20										0.51A		
21		0.23										
22												
23						A						
24						0.82A						
25												
26								0.16				
27				0.08								
28						A						
29												
30				0.01								
31			0.18									
Totals	0.00	0.98	4.95	0.85	0.90	0.52	0.48	0.97	0.07	0.51	0.00	2.03
										Water Year Total:		12.26

NOTE: All Values are in units of inches, unless otherwise specified.

LEGEND: A - Acculated Total
 E - Estimated
 T - Trace, unmeasurable amount of rain

Data Revised: April 2016
A - 46

PRECIPITATION

DAILY RAINFALL SUMMARY

453D Devil's Gate Dam

Gage Type: Standard Gage

Observation Time: Figures are for a 24-hour period

Latitude 34-10-53

Longitude: 118-10-27

Elevation: 980 Feet

Water Year from 10/01/2014 to 09/30/2015

Day	Oct	Nov	Dec	Jan	Feb	Mar	Apr	May	Jun	Jul	Aug	Sep
1		0.22	0.34			A						
2			0.03			0.26A						
3			2.19			0.35						
4			0.34						0.02			
5									0.01			
6												
7												
8					0.07		0.15	0.06				
9								0.03	0.01			
10												
11				A					0.01			
12			2.29	0.73A								
13			1.07E									
14												
15								0.18				2.32
16			0.13					0.80				0.12
17			1.03E									
18												
19						0.02				A		
20										1.53A		
21												
22												
23					0.42							
24					0.88							
25												
26							0.15					
27				0.09								
28												
29												
30												
31			0.07									
Totals	0.00	0.22	7.49	0.82	1.37	0.63	0.30	1.07	0.05	1.53	0.00	2.44
										Water Year Total:		15.92

NOTE: All Values are in units of inches, unless otherwise specified.

LEGEND: A - Acculated Total
 E - Estimated
 T - Trace, unmeasurable amount of rain

Data Revised: April 2016
A - 47

PRECIPITATION

DAILY RAINFALL SUMMARY

455B Lancaster-State Hwy Maintenance Sta.

Gage Type: Standard Gage

Observation Time: Figures are for a 24-hour period

Latitude 34-40-57

Longitude: 118-08-02

Elevation: 2395 Feet

Water Year from 10/01/2014 to 09/30/2015

Day	Oct	Nov	Dec	Jan	Feb	Mar	Apr	May	Jun	Jul	Aug	Sep
1		A				0.05				0.05		
2		0.20A										
3			1.22									
4			0.06									
5												
6												
7								0.04				
8												
9									0.03			
10												
11				A								
12			0.90	0.89A								
13			0.21									
14								0.16				
15												0.38
16			0.05									0.05
17			0.23									
18												
19						0.03				0.73E		
20										0.77E		
21												
22												
23					0.28							
24												
25								T				
26												
27				0.30								
28						T						
29				0.55								
30				0.15						0.03		
31												
Totals	0.00	0.20	2.67	1.89	0.28	0.08	0.00	0.20	0.03	1.58	0.00	0.43
										Water Year Total:		7.36

NOTE: All Values are in units of inches, unless otherwise specified.

LEGEND: A - Acculated Total
 E - Estimated
 T - Trace, unmeasurable amount of rain

PRECIPITATION

DAILY RAINFALL SUMMARY

465C Sepulveda Dam

Gage Type: Standard Gage

Observation Time: Figures are for a 24-hour period

Latitude 34-10-06

Longitude: 118-28-11

Elevation: 683 Feet

Water Year from 10/01/2014 to 09/30/2015

Day	Oct	Nov	Dec	Jan	Feb	Mar	Apr	May	Jun	Jul	Aug	Sep
1		0.35	0.12			0.25						
2			1.39			0.59						
3			0.43			0.04						
4			0.01									
5												
6												
7					0.01		0.03					
8								0.01				
9												
10				0.11								
11				1.37								
12			2.01									
13												
14								0.01				
15								0.33				0.85
16			0.23									
17			2.00									
18										0.65		
19										0.12		
20												
21												
22						0.02						
23						0.36						
24												
25												
26												
27				0.05								
28												
29												
30		0.87		0.15								
31												
Totals	0.00	1.22	6.19	1.68	0.39	0.88	0.03	0.35	0.00	0.77	0.00	0.85
												Water Year Total: 12.36

NOTE: All Values are in units of inches, unless otherwise specified.

LEGEND: A - Acculated Total
 E - Estimated
 T - Trace, unmeasurable amount of rain

Data Revised: April 2016
A - 49

PRECIPITATION

DAILY RAINFALL SUMMARY

482 Los Angeles-U.S.C.

Gage Type: Standard Gage

Observation Time: Figures are for a 24-hour period

Latitude 34-01-14

Longitude: 118-17-15

Elevation: 208 Feet

Water Year from 10/01/2014 to 09/30/2015

Day	Oct	Nov	Dec	Jan	Feb	Mar	Apr	May	Jun	Jul	Aug	Sep
1		0.18				0.66						
2			1.21			0.21						
3			0.31						T			
4									T			
5									T			
6												
7					0.02		0.13	0.03				
8								0.18				
9									0.01			
10				0.48								
11			0.01	0.50		T						
12			1.60									T
13		T										
14								0.69				
15			T					0.03				2.39
16			0.41									
17			0.15									
18						T		T		0.36		
19										0.02		
20		T								T		
21												
22					0.70							
23					T							
24												
25							T				T	
26				0.08								
27									T			
28					0.11				T			
29				T								
30		0.30	0.19	0.03					T			
31	0.25											
Totals	0.25	0.48	3.88	1.09	0.83	0.87	0.13	0.93	0.01	0.38	0.00	2.39
											Water Year Total:	11.24

NOTE: All Values are in units of inches, unless otherwise specified.

LEGEND: A - Acculated Total

E - Estimated

T - Trace, unmeasurable amount of rain

Data Revised: April 2016

A - 50

PRECIPITATION

DAILY RAINFALL SUMMARY

497 **Claremont-Slaughter**

Gage Type: Standard Private

Observation Time: Figures are for a 24-hour period

Latitude 34-07-35

Longitude: 117-43-55

Elevation: 1350 Feet

Water Year from 10/01/2014 to 09/30/2015

Day	Oct	Nov	Dec	Jan	Feb	Mar	Apr	May	Jun	Jul	Aug	Sep
1		0.64	0.01			0.28				0.01		
2						0.24						
3			0.56									
4			0.48									
5												
6											0.03	
7							0.35	0.04				
8								0.50				
9				0.01								
10				0.05								
11				0.50								
12			1.32	0.18								
13			0.02						0.05			
14								0.31				
15								0.41				1.16
16			0.06									0.05
17			0.74									
18										0.24		
19										0.29		
20										0.32		
21		0.99	0.01									
22					0.34							
23					1.20			0.07				
24												
25							0.15					
26				0.17			0.01					
27				0.13								
28					0.06							
29				0.02								
30		0.30	0.14						0.01			
31			0.01									
Totals	0.00	1.93	3.35	1.06	1.60	0.52	0.51	1.33	0.06	0.86	0.03	1.21
										Water Year Total:		12.46

NOTE: All Values are in units of inches, unless otherwise specified.

LEGEND: A - Acculated Total
 E - Estimated
 T - Trace, unmeasurable amount of rain

Data Revised: April 2016
A - 51

PRECIPITATION

DAILY RAINFALL SUMMARY

542 Fairmont

Gage Type: Standard Gage

Observation Time: Figures are for a 24-hour period

Latitude 34-42-15

Longitude: 118-25-40

Elevation: 3050 Feet

Water Year from 10/01/2014 to 09/30/2015

Day	Oct	Nov	Dec	Jan	Feb	Mar	Apr	May	Jun	Jul	Aug	Sep
1		0.54	0.05			0.19						
2		0.27	0.03			0.05						
3			2.22			0.06						
4			0.20									
5												
6												
7												
8							0.12					
9								0.01	0.01			
10												0.20
11				1.41								
12			1.65	0.02								
13			0.73						0.01			
14												
15								0.39				0.23
16			T									0.01
17			0.39									
18			T									
19										1.01		
20										0.24		
21												
22						0.01						
23						0.76						
24						0.01						
25												
26							0.10					
27				0.20								
28				T								
29												
30		T		0.03								
31												
Totals	0.00	0.81	5.27	1.66	0.78	0.30	0.22	0.40	0.02	1.25	0.00	0.44
Water Year Total:												11.15

NOTE: All Values are in units of inches, unless otherwise specified.

LEGEND: A - Acculated Total
 E - Estimated
 T - Trace, unmeasurable amount of rain

PRECIPITATION

DAILY RAINFALL SUMMARY

591B Santa Anita Reservoir

Gage Type: Standard Gage

Observation Time: Figures are for a 24-hour period

Latitude 34-11-08

Longitude: 118-06-16

Elevation: 1205 Feet

Water Year from 10/01/2014 to 09/30/2015

Day	Oct	Nov	Dec	Jan	Feb	Mar	Apr	May	Jun	Jul	Aug	Sep
1		0.89	0.27			0.06						
2			0.50			0.38						
3			1.00									
4			0.45						0.01			
5												
6												
7												
8					0.08E		0.31	0.23				
9												
10												
11				0.74								
12			1.81	0.08								
13			0.69									
14												
15								1.12				2.10
16			0.15									0.25
17			0.70									
18										0.04		
19						0.10				0.24		
20										0.47		
21												
22												
23					1.32							
24					0.50							
25												
26							0.17E					
27				0.11								
28					0.13							
29												
30												
31			0.06									
Totals	0.00	0.89	5.63	0.93	2.03	0.54	0.48	1.35	0.01	0.75	0.00	2.35
												Water Year Total: 14.96

NOTE: All Values are in units of inches, unless otherwise specified.

LEGEND: A - Acculated Total
 E - Estimated
 T - Trace, unmeasurable amount of rain

PRECIPITATION

DAILY RAINFALL SUMMARY

598D Neenach-Check 43-California D.W.R.

Gage Type: Standard Gage

Observation Time: Figures are for a 24-hour period

Latitude 34-47-40

Longitude: 118-37-15

Elevation: 2965 Feet

Water Year from 10/01/2014 to 09/30/2015

Day	Oct	Nov	Dec	Jan	Feb	Mar	Apr	May	Jun	Jul	Aug	Sep
1			0.02		0.04					0.09		
2		0.42	0.20			0.11						
3		0.01	1.28			0.28						
4			0.05			0.01						
5			0.03									
6												
7												
8							0.04	0.09				
9								0.02	0.01			
10									0.01			
11				1.01								
12			1.40	0.01								
13			0.15									
14			0.05									
15								0.03				0.48
16			0.04									
17			0.11									
18												
19										1.04		
20										0.66		
21		0.03										
22								0.01				
23					0.14		0.33					
24					0.01		0.33					
25							0.03					
26			0.04				0.02					
27				0.23								
28				0.01								
29												
30				0.11								
31				0.02								
Totals	0.00	0.46	3.37	1.39	0.19	0.40	0.75	0.15	0.02	1.79	0.00	0.48
											Water Year Total:	9.00

NOTE: All Values are in units of inches, unless otherwise specified.

LEGEND: A - Acculated Total
 E - Estimated
 T - Trace, unmeasurable amount of rain

Data Revised: April 2016
A - 54

PRECIPITATION

DAILY RAINFALL SUMMARY

610B Pasadena-City Hall

Gage Type: Daily Automatic

Observation Time: 2400

Latitude 34-08-54

Longitude: 118-08-36

Elevation: 864 Feet

Water Year from 10/01/2014 to 09/30/2015

Day	Oct	Nov	Dec	Jan	Feb	Mar	Apr	May	Jun	Jul	Aug	Sep
1		0.49E		0.01		0.95					0.01	
2			1.88			0.68						
3			0.58						0.01			
4			0.22		0.01			0.01				
5									0.01			
6												
7					0.07		0.21E					
8					0.08			0.14				
9									0.01			
10				0.07	0.01				0.01			
11				1.13					0.02			
12			3.42	0.01								
13												
14								0.57				
15				0.01				0.47				1.65
16			0.40									0.40
17			0.81									
18										0.13		
19						0.04				0.27		
20										0.23		
21										0.01		
22			0.01		0.32							
23					1.02							
24					0.02							
25								0.16E				
26												
27				0.25								
28												
29												
30		0.18E	0.16	0.02								
31			0.18	0.01								
Totals	0.00	0.67	7.66	1.51	1.53	1.67	0.37	1.19	0.06	0.64	0.01	2.05
											Water Year Total:	17.36

NOTE: All Values are in units of inches, unless otherwise specified.

LEGEND: A - Acculated Total
 E - Estimated
 T - Trace, unmeasurable amount of rain

Data Revised: April 2016
A - 55

PRECIPITATION

DAILY RAINFALL SUMMARY

612B Pasadena-Chlorine Plant

Gage Type: Standard Gage

Observation Time: Figures are for a 24-hour period

Latitude 34-12-04

Longitude: 118-09-49

Elevation: 1160 Feet

Water Year from 10/01/2014 to 09/30/2015

Day	Oct	Nov	Dec	Jan	Feb	Mar	Apr	May	Jun	Jul	Aug	Sep
1		0.52	0.28			0.16						
2			0.19			0.26						
3			1.40									
4			0.35						0.07E			
5												
6												
7												
8					0.05E		0.15	0.12				
9												
10												
11				0.64								
12			1.31									
13			0.95									
14												
15								1.00				1.80
16			0.12									0.16
17			1.20									
18										0.13		
19						0.09				0.24		
20										1.11		
21												
22												
23					0.80							
24					0.17							
25												
26							0.16E					
27				0.14								
28												
29												
30												
31			0.02									
Totals	0.00	0.52	5.82	0.78	1.02	0.51	0.31	1.12	0.07	1.48	0.00	1.96
										Water Year Total:		13.59

NOTE: All Values are in units of inches, unless otherwise specified.

LEGEND: A - Acculated Total
 E - Estimated
 T - Trace, unmeasurable amount of rain

PRECIPITATION

DAILY RAINFALL SUMMARY

613C Pasadena Fire Station

Gage Type: Standard Gage

Observation Time: Figures are for a 24-hour period

Latitude 34-07-15

Longitude: 118-08-05

Elevation: 779 Feet

Water Year from 10/01/2014 to 09/30/2015

Day	Oct	Nov	Dec	Jan	Feb	Mar	Apr	May	Jun	Jul	Aug	Sep
1		0.57	0.14			0.08						
2			0.90			0.34						
3			0.70									
4			0.36									
5												
6												
7												
8					0.05E		0.22	0.10				
9												
10				A								
11				0.65A								
12			1.51									
13			0.71									
14												
15								0.62				2.41
16			0.15									0.10
17			0.61									
18										0.03		
19						0.05				0.21		
20										0.15		
21												
22												
23					0.77							
24					0.05							
25												
26							0.17E					
27				0.13								
28												
29												
30												
31			0.27									
Totals	0.00	0.57	5.35	0.78	0.87	0.47	0.39	0.72	0.00	0.39	0.00	2.51
											Water Year Total:	12.05

NOTE: All Values are in units of inches, unless otherwise specified.

LEGEND: A - Acculated Total
 E - Estimated
 T - Trace, unmeasurable amount of rain

PRECIPITATION

DAILY RAINFALL SUMMARY

626 Thompson Creek Dam Precipitation

Gage Type: Standard Gage

Observation Time: Figures are for a 24-hour period

Latitude 34-08-26

Longitude: 117-42-39

Elevation: 1670 Feet

Water Year from 10/01/2014 to 09/30/2015

Day	Oct	Nov	Dec	Jan	Feb	Mar	Apr	May	Jun	Jul	Aug	Sep
1		0.66	0.39			0.18						
2		T	0.06			0.13						
3			1.48			0.15						
4			0.71									
5			0.01									
6												
7								0.02				
8							0.32	0.28				
9								0.24				
10												
11				0.49								
12			1.12	0.25								
13			0.17							T		
14												
15								0.76E				0.48
16								0.05				0.67
17			0.78									
18												
19										0.47E		
20										0.34E		
21		0.18										
22								0.04				
23					1.20			0.02				
24					0.33							
25												
26							0.11					
27				0.30								
28					0.11							
29												
30				0.01								
31			0.15									
Totals	0.00	0.84	4.87	1.05	1.64	0.46	0.43	1.41	0.00	0.81	0.00	1.15
										Water Year Total:		12.66

NOTE: All Values are in units of inches, unless otherwise specified.

LEGEND: A - Acculated Total
 E - Estimated
 T - Trace, unmeasurable amount of rain

PRECIPITATION

DAILY RAINFALL SUMMARY

627 San Gabriel Canyon-Power House

Gage Type: Standard Gage

Observation Time: Figures are for a 24-hour period

Latitude 34-09-20

Longitude: 117-54-28

Elevation: 744 Feet

Water Year from 10/01/2014 to 09/30/2015

Day	Oct	Nov	Dec	Jan	Feb	Mar	Apr	May	Jun	Jul	Aug	Sep
1		0.70	0.24			0.15						
2		0.11	0.01			0.12						
3			1.73			0.16						
4			0.48									
5									0.02			
6												
7												
8					0.07		0.36	0.17				
9												
10												0.13
11				0.70					0.02			
12			1.38	0.09								
13			0.60									
14												
15								0.66				1.58
16												0.10
17			0.75									
18										0.13		
19								0.01		0.28		
20										0.53		
21		0.22										
22												
23					0.79			0.03				
24					0.53							
25												
26							0.13					
27				0.34								
28					0.08							
29												
30		0.04								0.03		
31			0.27									
Totals	0.00	1.07	5.46	1.13	1.47	0.43	0.49	0.87	0.04	0.97	0.00	1.81
										Water Year Total:		13.74

NOTE: All Values are in units of inches, unless otherwise specified.

LEGEND: A - Acculated Total
 E - Estimated
 T - Trace, unmeasurable amount of rain

PRECIPITATION

DAILY RAINFALL SUMMARY

662D Long Beach Airport

Gage Type: Standard Gage

Observation Time: Figures are for a 24-hour period

Latitude 33-49-00

Longitude: 118-09-00

Elevation: 34 Feet

Water Year from 10/01/2014 to 09/30/2015

Day	Oct	Nov	Dec	Jan	Feb	Mar	Apr	May	Jun	Jul	Aug	Sep
1		0.15	0.10			0.03				T		
2		T	1.04			0.46				T		
3			0.81									
4												
5												
6												
7					T		0.21	T				
8								0.19				
9									0.01			0.02
10				0.35								
11			T	0.40		T						
12			1.54									
13		T	0.01						T			
14		0.01						0.49				
15								0.09				0.93
16			0.34									
17			0.53									
18			T							0.35		
19										0.19		
20												
21												
22						0.18				T		
23						0.06						
24												
25								0.01			T	
26				0.10								
27										T		
28						T				T		
29				T								
30		0.51	0.04	0.02						T		
31	0.18		T									
Totals	0.18	0.67	4.41	0.87	0.24	0.49	0.22	0.77	0.01	0.54	0.00	0.95
										Water Year Total:		9.35

NOTE: All Values are in units of inches, unless otherwise specified.

LEGEND: A - Acculated Total

E - Estimated

T - Trace, unmeasurable amount of rain

Data Revised: April 2016

A - 60

PRECIPITATION

DAILY RAINFALL SUMMARY

680B Westwood (U.C.L.A.)

Gage Type: Standard Gage

Observation Time: Figures are for a 24-hour period

Latitude 34-04-10

Longitude: 118-26-30

Elevation: 430 Feet

Water Year from 10/01/2014 to 09/30/2015

Day	Oct	Nov	Dec	Jan	Feb	Mar	Apr	May	Jun	Jul	Aug	Sep
1		0.42	0.25			0.42						
2			1.25			0.69						
3			0.42			0.02						
4			T									
5												
6												
7					T		0.02					
8					0.02		0.33	0.01				
9												
10				0.06								
11				1.23								
12			1.53									
13												
14		0.01						0.08				
15								0.70				2.62
16			0.30									T
17			0.51									
18			T							0.13		
19						T				0.10		
20												
21		T										
22					0.02							
23					0.57							
24												
25											T	
26												
27				0.09								
28												
29												
30		0.07		0.06								
31			0.07									
Totals	0.00	0.50	4.33	1.44	0.61	1.13	0.35	0.79	0.00	0.23	0.00	2.62
Water Year Total:												12.00

NOTE: All Values are in units of inches, unless otherwise specified.

LEGEND: A - Acculated Total

E - Estimated

T - Trace, unmeasurable amount of rain

Data Revised: April 2016

A - 61

PRECIPITATION

DAILY RAINFALL SUMMARY

716 Los Angeles-Ducommun St.

Gage Type: Standard Gage

Observation Time: Figures are for a 24-hour period

Latitude 34-03-09

Longitude: 118-14-13

Elevation: 306 Feet

Water Year from 10/01/2014 to 09/30/2015

Day	Oct	Nov	Dec	Jan	Feb	Mar	Apr	May	Jun	Jul	Aug	Sep
1		0.34	0.30			0.02E						
2						0.83E						
3			1.13									
4			0.41									
5												
6												
7												
8					0.02E		0.14	0.13				
9												
10									0.01			
11				0.66					0.01			
12			1.06E	0.06								
13			0.55E									
14												
15								0.75				2.34
16								0.01				0.01
17			0.47									
18			0.02									
19										0.35		
20										0.03		
21												
22												
23					0.52E							
24												
25												
26							0.02E					
27				0.18								
28												
29												
30				0.01								
31			0.19	0.20E								
Totals	0.00	0.34	4.13	1.11	0.54	0.85	0.16	0.89	0.02	0.38	0.00	2.35
											Water Year Total:	10.77

NOTE: All Values are in units of inches, unless otherwise specified.

LEGEND: A - Acculated Total
 E - Estimated
 T - Trace, unmeasurable amount of rain

Data Revised: April 2016
 A - 62

PRECIPITATION

DAILY RAINFALL SUMMARY

734C Los Angeles International Airport

Gage Type: Standard Gage

Observation Time: Figures are for a 24-hour period

Latitude 33-56-25

Longitude: 118-23-44

Elevation: 105 Feet

Water Year from 10/01/2014 to 09/30/2015

Day	Oct	Nov	Dec	Jan	Feb	Mar	Apr	May	Jun	Jul	Aug	Sep
1		0.20				0.25				T		
2			1.12			0.17				T		
3			0.21			0.07						
4												
5												
6												
7					T		0.10	0.11				
8								0.10				
9									0.01			0.01
10				0.69								
11			T	0.39		T			T			
12			1.49									T
13		T							T			
14		T						0.19				
15			T					0.03				1.80
16			0.73									
17			0.18									
18			T			T				0.32		
19										0.03		
20		T										
21												
22					0.27					T		
23					T							
24												
25							0.01					
26				0.13								
27				T					T			
28					T							
29				T								
30		0.22	0.31	0.04					T			
31	0.24											
Totals	0.24	0.42	4.04	1.25	0.27	0.49	0.11	0.43	0.01	0.35	0.00	1.81
										Water Year Total:		9.42

NOTE: All Values are in units of inches, unless otherwise specified.

LEGEND: A - Acculated Total
 E - Estimated
 T - Trace, unmeasurable amount of rain

PRECIPITATION

DAILY RAINFALL SUMMARY

747 Sandberg-Airways Station

Gage Type: Standard Gage

Observation Time: Figures are for a 24-hour period

Latitude 34-44-47

Longitude: 118-43-29

Elevation: 4517 Feet

Water Year from 10/01/2014 to 09/30/2015

Day	Oct	Nov	Dec	Jan	Feb	Mar	Apr	May	Jun	Jul	Aug	Sep
1		0.01				0.21				T		
2		T	1.49			0.06				T		
3			0.58									
4												
5												
6												
7					T		0.05	0.11				
8					0.01		T	0.02				
9									0.05			0.05
10				0.15					0.06			
11			0.47	0.83		T						
12			1.55									
13			0.02									
14		T					T	0.03				0.01
15			0.02									0.69
16			0.06									0.07
17			0.06									
18			T							0.64		
19		T								0.38		
20		0.01	0.03							T		
21		0.01					0.08	T				
22		0.03			0.09		T	0.07				
23		0.01			0.03		T	T				
24			0.01					0.03				
25			0.01				0.08					
26				0.18								
27				0.30						T		
28					0.01					T		
29		T		T								
30		0.04	T	0.04						0.24		
31	0.49											
Totals	0.49	0.11	4.30	1.50	0.14	0.27	0.21	0.26	0.11	1.26	0.00	0.82
										Water Year Total:		9.47

NOTE: All Values are in units of inches, unless otherwise specified.

LEGEND: A - Acculated Total

E - Estimated

T - Trace, unmeasurable amount of rain

Data Revised: April 2016

A - 64

PRECIPITATION

DAILY RAINFALL SUMMARY

749B Burbank Valley Pump Plant

Gage Type: Standard Gage

Observation Time: Figures are for a 24-hour period

Latitude 34-11-11

Longitude: 118-20-54

Elevation: 655 Feet

Water Year from 10/01/2014 to 09/30/2015

Day	Oct	Nov	Dec	Jan	Feb	Mar	Apr	May	Jun	Jul	Aug	Sep
1		0.05	0.49			0.85						
2			1.80			0.06						
3			0.03									
4												
5												
6												
7					0.03		0.07	0.05				
8												
9												
10				0.67								
11			1.25	0.09								
12			0.32									
13												
14								0.24				0.89
15			0.03									0.50
16			0.98									0.01
17			0.10									
18						0.05				0.48		
19										0.05		
20												
21												
22						0.45						
23						0.15						
24												
25								0.11				
26				0.13								
27												
28						0.43						
29												
30		0.46		0.31								
31	0.36											
Totals	0.36	0.51	5.00	1.20	1.06	0.96	0.18	0.29	0.00	0.53	0.00	1.40
										Water Year Total:		11.49

NOTE: All Values are in units of inches, unless otherwise specified.

LEGEND: A - Acculated Total
 E - Estimated
 T - Trace, unmeasurable amount of rain

PRECIPITATION

DAILY RAINFALL SUMMARY

750B Palmdale-F.A.A. Airport

Gage Type: Standard Gage

Observation Time: Figures are for a 24-hour period

Latitude 34-37-20

Longitude: 118-05-00

Elevation: 2528 Feet

Water Year from 10/01/2014 to 09/30/2015

Day	Oct	Nov	Dec	Jan	Feb	Mar	Apr	May	Jun	Jul	Aug	Sep
1		0.16E				0.03				0.03		
2			1.20			T						
3			0.11									
4												
5												
6									T		T	
7							T	T				
8												
9									0.01			
10				0.09								
11				0.56		T						
12			1.10						0.01			
13												
14								0.10				
15		T	T									0.43
16			0.02									
17			0.14									
18						0.03E				0.53		
19		T								0.38		
20										0.01		
21												
22					0.36							
23					0.02							
24			T									
25			T				0.08					
26				0.03								
27												
28					T							
29				T					T	0.65		
30		T	T	0.05					0.01	T		
31	T											
Totals	0.00	0.16	2.57	0.73	0.38	0.06	0.08	0.10	0.03	1.60	0.00	0.43
										Water Year Total:		6.14

NOTE: All Values are in units of inches, unless otherwise specified.

LEGEND: A - Acculated Total
 E - Estimated
 T - Trace, unmeasurable amount of rain

PRECIPITATION

DAILY RAINFALL SUMMARY

795 **Pasadena-Jourdan**

Gage Type: Standard Gage

Observation Time: Figures are for a 24-hour period

Latitude 34-08-52

Longitude: 118-05-14

Elevation: 705 Feet

Water Year from 10/01/2014 to 09/30/2015

Day	Oct	Nov	Dec	Jan	Feb	Mar	Apr	May	Jun	Jul	Aug	Sep
1		0.48	0.18			0.05						
2			0.55			0.26						
3			0.85									
4			0.31									
5												
6												
7												
8					0.05E		0.22	0.09				
9												
10												
11				0.66								
12			1.12									
13			0.84									
14												
15								0.65				2.00
16			0.06									0.05
17			0.55									
18										0.01		
19						0.06				0.18		
20										0.15		
21												
22												
23					0.84							
24					0.48							
25												
26							0.17E					
27				0.10								
28												
29												
30												
31			0.20									
Totals	0.00	0.48	4.66	0.76	1.37	0.37	0.39	0.74	0.00	0.34	0.00	2.05
												Water Year Total: 11.16

NOTE: All Values are in units of inches, unless otherwise specified.

LEGEND: A - Acculated Total
 E - Estimated
 T - Trace, unmeasurable amount of rain

Data Revised: April 2016
A - 67

PRECIPITATION

DAILY RAINFALL SUMMARY

1037 Arcadia-Arboretum

Gage Type: Standard Gage

Observation Time: Figures are for a 24-hour period

Latitude 34-08-48

Longitude: 118-02-59

Elevation: 565 Feet

Water Year from 10/01/2014 to 09/30/2015

Day	Oct	Nov	Dec	Jan	Feb	Mar	Apr	May	Jun	Jul	Aug	Sep
1		0.50				A						
2			0.84			0.36A						
3			0.71			0.02						
4			0.43									
5									0.01			
6												
7					T							
8					0.07		0.23	0.21				
9								0.01				
10												
11				0.65					0.02			
12			1.84									T
13			0.01									
14								0.24				
15								0.70				1.75
16												0.08
17			0.67									
18										0.03		
19						0.02				0.26		
20										0.32		
21		0.40										
22						A						
23						0.86A						
24						0.39						
25												
26								0.14				
27				0.09	0.06							
28												
29												
30		0.25									T	
31			0.26	0.02								
Totals	0.00	1.15	4.76	0.76	1.38	0.40	0.37	1.16	0.03	0.61	0.00	1.83
										Water Year Total:		12.45

NOTE: All Values are in units of inches, unless otherwise specified.

LEGEND: A - Acculated Total
 E - Estimated
 T - Trace, unmeasurable amount of rain

PRECIPITATION

DAILY RAINFALL SUMMARY

1041B Santa Fe Dam

Gage Type: Standard Gage

Observation Time: Figures are for a 24-hour period

Latitude 34-07-04

Longitude: 117-58-24

Elevation: 427 Feet

Water Year from 10/01/2014 to 09/30/2015

Day	Oct	Nov	Dec	Jan	Feb	Mar	Apr	May	Jun	Jul	Aug	Sep
1		0.53	0.09			0.08						
2			1.50			0.53						
3			0.18									
4			0.48									
5												
6												
7												
8					0.01		0.23	0.17				
9												0.02
10				0.03								
11				0.51								
12			1.70									
13												
14								0.43				
15								0.23				1.52
16			0.02									0.10
17			0.43									
18										0.15		
19										1.41		
20										0.07		
21												
22					0.13							
23					0.75							
24												
25							0.21					
26				0.10								
27				0.06								
28												
29												
30		0.10	0.24							0.03		
31			0.01									
Totals	0.00	0.63	4.65	0.70	0.89	0.61	0.44	0.83	0.00	1.66	0.00	1.64
											Water Year Total:	12.05

NOTE: All Values are in units of inches, unless otherwise specified.

LEGEND: A - Acculated Total
 E - Estimated
 T - Trace, unmeasurable amount of rain

Data Revised: April 2016
A - 69

PRECIPITATION

DAILY RAINFALL SUMMARY

1051B Canoga Park-Pierce College

Gage Type: Standard Gage

Observation Time: Figures are for a 24-hour period

Latitude 34-10-51

Longitude: 118-34-23

Elevation: 800 Feet

Water Year from 10/01/2014 to 09/30/2015

Day	Oct	Nov	Dec	Jan	Feb	Mar	Apr	May	Jun	Jul	Aug	Sep
1		0.35	0.04			0.55						
2			1.44			0.43						
3			0.34			0.04						
4			0.09									
5												
6												
7					0.03							
8					0.02		0.06	T				
9									0.04			
10				0.13								
11				1.12								
12			1.57									
13												
14								0.04				T
15								0.17				0.59
16			0.23									
17			0.14									
18			T							0.27		
19						T				0.40		
20										0.04		
21		T										
22					0.03							
23					0.32							
24												
25												
26				T								
27				0.33								
28												
29												
30		0.60		0.02								
31												
Totals	0.00	0.95	3.85	1.60	0.40	1.02	0.06	0.21	0.04	0.71	0.00	0.59
												Water Year Total: 9.43

NOTE: All Values are in units of inches, unless otherwise specified.

LEGEND: A - Acculated Total
 E - Estimated
 T - Trace, unmeasurable amount of rain

PRECIPITATION

DAILY RAINFALL SUMMARY

1058B Palmdale

Gage Type: Standard Gage

Observation Time: Figures are for a 24-hour period

Latitude 34-35-17

Longitude: 118-05-31

Elevation: 2595 Feet

Water Year from 10/01/2014 to 09/30/2015

Day	Oct	Nov	Dec	Jan	Feb	Mar	Apr	May	Jun	Jul	Aug	Sep
1		0.25				0.12						
2		0.01	1.09			0.04						
3			0.19									
4			0.11									
5												
6												
7												
8								0.02				
9												
10				0.05								
11				0.90								
12			1.35	0.04								
13												
14												
15								0.10				0.50
16			0.04									
17			0.22									
18			0.02							0.25		
19						0.06				0.45		
20										0.38		
21												
22												
23					0.49							
24												
25								0.11				
26												
27				0.03								
28												
29												
30				0.08						0.08		
31										0.07		
Totals	0.00	0.26	3.02	1.10	0.49	0.22	0.11	0.12	0.00	1.23	0.00	0.50
										Water Year Total:		7.05

NOTE: All Values are in units of inches, unless otherwise specified.

LEGEND: A - Acculated Total
 E - Estimated
 T - Trace, unmeasurable amount of rain

PRECIPITATION

DAILY RAINFALL SUMMARY

1081B Glendale-Gregg

Gage Type: Standard Private

Observation Time: Figures are for a 24-hour period

Latitude 34-11-45

Longitude: 118-14-30

Elevation: 1350 Feet

Water Year from 10/01/2014 to 09/30/2015

Day	Oct	Nov	Dec	Jan	Feb	Mar	Apr	May	Jun	Jul	Aug	Sep
1		0.49				0.04						
2			1.25			0.44						
3			0.28						T			
4			0.07						0.03			
5									0.02			
6												
7					0.05		T					
8							0.15	0.08				
9									T			
10				0.08					T			
11				0.76					T			
12			1.96									
13												
14								0.31				
15								0.39				1.78
16			0.29									0.06
17			1.00									
18						T				0.55		
19						T				0.12		
20												
21		T								0.30		
22					0.23					0.01		
23					0.84							
24							T					
25							0.24				T	
26				0.08			T					
27				T	T				T			
28					0.11							
29												
30		0.48	T	0.07					T			
31	0.15		T									
Totals	0.15	0.97	4.85	0.99	1.23	0.48	0.39	0.78	0.05	0.98	0.00	1.84
										Water Year Total:		12.71

NOTE: All Values are in units of inches, unless otherwise specified.

LEGEND: A - Acculated Total
 E - Estimated
 T - Trace, unmeasurable amount of rain

Data Revised: April 2016
 A - 72

PRECIPITATION

DAILY RAINFALL SUMMARY

1088B La Habra Heights-Mutual Water Co.

Gage Type: Standard Gage

Observation Time: Figures are for a 24-hour period

Latitude 33-56-55

Longitude: 117-57-51

Elevation: 445 Feet

Water Year from 10/01/2014 to 09/30/2015

Day	Oct	Nov	Dec	Jan	Feb	Mar	Apr	May	Jun	Jul	Aug	Sep
1		A	0.75			0.10						
2		0.53A				0.38						
3			1.03			0.02						
4			0.69									
5												
6												
7							0.08					
8								0.48				
9								0.20				
10												
11				0.37								
12			1.15	0.20								
13			0.21									
14												
15								0.34				1.02
16								0.13				0.09
17			0.30									
18												
19										0.38		
20										0.15		
21												
22					0.55							
23												
24												
25												
26												
27				0.22								
28												
29												
30												
31			0.05									
Totals	0.00	0.53	4.18	0.79	0.55	0.50	0.08	1.15	0.00	0.53	0.00	1.11
												Water Year Total: 9.42

NOTE: All Values are in units of inches, unless otherwise specified.

LEGEND: A - Acculated Total
 E - Estimated
 T - Trace, unmeasurable amount of rain

Data Revised: April 2016
A - 73

PRECIPITATION

DAILY RAINFALL SUMMARY

1095 Orange County Reservoir

Gage Type: Standard Gage

Observation Time: Figures are for a 24-hour period

Latitude 33-56-07

Longitude: 117-52-58

Elevation: 660 Feet

Water Year from 10/01/2014 to 09/30/2015

Day	Oct	Nov	Dec	Jan	Feb	Mar	Apr	May	Jun	Jul	Aug	Sep
1		0.55	1.17			0.11						
2			0.96			0.36						
3			0.59									
4			0.46									
5												
6												
7												
8							0.07	0.36				
9												
10				0.05								
11				0.67								
12			1.42	0.02								
13			0.01									
14								0.25				
15								0.11				1.36
16												0.07
17			0.35									
18										0.33		
19										0.49		
20										0.14		
21												
22						0.11						
23						0.51						
24								0.01				
25								0.03				
26												
27				0.19								
28												
29												
30		0.50										
31			0.04									
Totals	0.00	1.05	5.00	0.93	0.62	0.47	0.11	0.72	0.00	0.96	0.00	1.43
										Water Year Total:		11.29

NOTE: All Values are in units of inches, unless otherwise specified.

LEGEND: A - Acculated Total
 E - Estimated
 T - Trace, unmeasurable amount of rain

PRECIPITATION

DAILY RAINFALL SUMMARY

1114B Whittier Narrows Dam

Gage Type: Standard Gage

Observation Time: Figures are for a 24-hour period

Latitude 34-01-29

Longitude: 118-05-02

Elevation: 239 Feet

Water Year from 10/01/2014 to 09/30/2015

Day	Oct	Nov	Dec	Jan	Feb	Mar	Apr	May	Jun	Jul	Aug	Sep
1		0.76	0.03			A						
2			1.02			0.67A						
3			0.40									
4			0.27									
5												
6												
7							0.03					
8							0.08	0.70				
9												
10				0.07								
11				0.57								
12			1.42									
13			0.01									
14								0.47				
15								0.02				1.19
16			0.01									
17			0.21									
18										0.10		
19										0.05		
20										0.01		
21		0.02										
22					0.02							
23					0.48							
24												
25												
26				0.08								
27				0.08								
28												
29												
30		0.31	0.13	0.01						0.01		
31			0.02	0.01								
Totals	0.00	1.09	3.52	0.82	0.50	0.67	0.11	1.19	0.00	0.17	0.00	1.19
										Water Year Total:		9.26

NOTE: All Values are in units of inches, unless otherwise specified.

LEGEND: A - Acculated Total
 E - Estimated
 T - Trace, unmeasurable amount of rain

PRECIPITATION

DAILY RAINFALL SUMMARY

1115 San Antonio Dam

Gage Type: Standard Gage

Observation Time: Figures are for a 24-hour period

Latitude 34-09-24

Longitude: 117-40-20

Elevation: 2120 Feet

Water Year from 10/01/2014 to 09/30/2015

Day	Oct	Nov	Dec	Jan	Feb	Mar	Apr	May	Jun	Jul	Aug	Sep
1		0.91	0.11			0.21						
2		0.02	1.24			0.21						
3			0.50									
4			0.72									
5												
6												
7								0.01				
8					0.01		0.29	0.57				
9				0.02								
10				0.03								
11				0.44								
12			1.49	0.01								
13									0.01			
14								0.40				
15								0.53				1.15
16			0.01									0.05
17			0.59									
18								0.03		0.23		
19										0.19		
20										0.37		
21		0.03										
22					0.45							
23					0.96							
24					0.03			0.04				
25							0.12	0.01				
26				0.14								
27				0.18								
28					0.07							
29												
30		0.18	0.10									
31												
Totals	0.00	1.14	4.76	0.82	1.52	0.42	0.41	1.59	0.01	0.79	0.00	1.20
												Water Year Total: 12.66

NOTE: All Values are in units of inches, unless otherwise specified.

LEGEND: A - Acculated Total
 E - Estimated
 T - Trace, unmeasurable amount of rain

Data Revised: April 2016
A - 76

PRECIPITATION

DAILY RAINFALL SUMMARY

1158 **Torrance Municipal Airport**

Gage Type: Standard Gage

Observation Time: Figures are for a 24-hour period

Latitude 33-47-59

Longitude: 118-20-08

Elevation: 102 Feet

Water Year from 10/01/2014 to 09/30/2015

Day	Oct	Nov	Dec	Jan	Feb	Mar	Apr	May	Jun	Jul	Aug	Sep
1		0.35				0.20						
2		0.20	0.95			0.67						
3			0.64			0.81						
4			0.03									
5												
6												
7												
8							0.10	0.30				
9									0.10			
10				0.19								0.12
11				0.28								
12			1.55									
13			0.05									
14		0.05						0.39				
15								0.17				0.45
16			1.10									
17			0.23									
18			0.01								0.17	
19											0.15	
20											0.15	
21												
22						0.04						
23						0.59						
24												
25								0.05				
26												
27				0.20								
28												
29												
30		0.14		0.04								
31			0.11									
Totals	0.00	0.74	4.67	0.71	0.63	1.68	0.15	0.86	0.10	0.47	0.00	0.57
Water Year Total:												10.58

NOTE: All Values are in units of inches, unless otherwise specified.

LEGEND: A - Acculated Total
 E - Estimated
 T - Trace, unmeasurable amount of rain

Data Revised: April 2016
A - 77

PRECIPITATION

DAILY RAINFALL SUMMARY

1212 Lancaster FSS/FAA

Gage Type: Standard Gage

Observation Time: Figures are for a 24-hour period

Latitude 34-44-00

Longitude: 118-13-00

Elevation: 2340 Feet

Water Year from 10/01/2014 to 09/30/2015

Day	Oct	Nov	Dec	Jan	Feb	Mar	Apr	May	Jun	Jul	Aug	Sep
1		0.16				0.04				0.03		
2			1.14			T				T		
3			0.09									
4												
5												
6									0.03			
7					T		0.01	0.19				
8												
9				T					0.01			T
10				0.13								
11				0.72		T						
12			1.19						T			
13												
14								0.09				
15			0.01									0.64
16			0.01									
17			0.18									
18						T				0.72		
19										1.59		
20		T								T		
21												
22					0.39							
23												
24												
25							T					
26				0.06								
27				0.01								
28					0.01							
29				0.01								
30		T		0.03								
31	0.14											
Totals	0.14	0.16	2.62	0.96	0.40	0.04	0.01	0.28	0.04	2.34	0.00	0.64
										Water Year Total:		7.63

NOTE: All Values are in units of inches, unless otherwise specified.

LEGEND: A - Acculated Total
 E - Estimated
 T - Trace, unmeasurable amount of rain

Data Revised: April 2016
 A - 78

PRECIPITATION

DAILY RAINFALL SUMMARY

1217 Los Angeles Country Club

Gage Type: Standard Gage

Observation Time: Figures are for a 24-hour period

Latitude 34-04-10

Longitude: 118-25-17

Elevation: 380 Feet

Water Year from 10/01/2014 to 09/30/2015

Day	Oct	Nov	Dec	Jan	Feb	Mar	Apr	May	Jun	Jul	Aug	Sep
1		0.48	0.01			0.86						
2			1.54			0.04						
3			0.19						T			
4												
5												
6												
7					0.05		0.32					
8					0.01			0.01				
9												
10				1.28								
11				0.10								
12			1.77									
13												
14								0.61				
15								0.04				2.62
16			0.27									
17			0.39									
18										0.22		
19												
20										0.01		
21												
22					0.42							
23												
24												
25												
26				0.10								
27												
28					0.15							
29												
30		0.29	0.16	0.13								
31												
Totals	0.00	0.77	4.33	1.61	0.63	0.90	0.32	0.66	0.00	0.23	0.00	2.62
										Water Year Total:		12.07

NOTE: All Values are in units of inches, unless otherwise specified.

LEGEND: A - Acculated Total
 E - Estimated
 T - Trace, unmeasurable amount of rain

PRECIPITATION

DAILY RAINFALL SUMMARY

1222 Northridge-Garland

Gage Type: Standard Private

Observation Time: Figures are for a 24-hour period

Latitude 34-14-17

Longitude: 118-30-59

Elevation: 911 Feet

Water Year from 10/01/2014 to 09/30/2015

Day	Oct	Nov	Dec	Jan	Feb	Mar	Apr	May	Jun	Jul	Aug	Sep
1		0.31	0.05			0.66						
2			1.41			0.58						
3			0.46			0.04						
4			0.07									
5												
6												
7					0.09		0.07					
8							0.04					
9												
10				0.11								
11				1.03								
12			2.13									
13												
14								0.06				
15								0.18				1.31
16			0.12									0.02
17			0.34									
18						0.02				0.24		
19										0.27		
20										0.14		
21												
22						0.06						
23						0.41						
24												
25												
26												
27				0.10								
28												
29												
30		0.55		0.03								
31												
Totals	0.00	0.86	4.58	1.27	0.56	1.30	0.11	0.24	0.00	0.65	0.00	1.33
										Water Year Total:		10.90

NOTE: All Values are in units of inches, unless otherwise specified.

LEGEND: A - Acculated Total
 E - Estimated
 T - Trace, unmeasurable amount of rain

Data Revised: April 2016
A - 80

PRECIPITATION

DAILY RAINFALL SUMMARY

1240 Pearblossom-Calif.D.W.R. Booster Sta.

Gage Type: Standard Gage

Observation Time: Figures are for a 24-hour period

Latitude 34-30-32

Longitude: 117-55-15

Elevation: 3050 Feet

Water Year from 10/01/2014 to 09/30/2015

Day	Oct	Nov	Dec	Jan	Feb	Mar	Apr	May	Jun	Jul	Aug	Sep
1		0.17								0.01		
2			0.03									
3			0.81									
4			0.01									
5												
6												
7												
8								0.05				
9				0.02					0.25			
10												0.03
11				0.40								
12			0.34	0.44								
13			0.23									
14												
15								0.11				0.40
16												0.01
17			0.23									
18										0.01		
19						0.02				0.41		
20										0.57		
21												
22												
23					0.55							
24					0.07							
25					0.01							
26							0.02					
27				0.07								
28												
29												
30												
31										0.36		
Totals	0.00	0.17	1.65	0.93	0.63	0.02	0.02	0.16	0.25	1.36	0.00	0.44
										Water Year Total:		5.63

NOTE: All Values are in units of inches, unless otherwise specified.

LEGEND: A - Acculated Total
 E - Estimated
 T - Trace, unmeasurable amount of rain

PRECIPITATION

DAILY RAINFALL SUMMARY

1252 Palos Verdes Landfill

Gage Type: Standard Gage

Observation Time: Figures are for a 24-hour period

Latitude 33-45-40

Longitude: 118-20-03

Elevation: 400 Feet

Water Year from 10/01/2014 to 09/30/2015

Day	Oct	Nov	Dec	Jan	Feb	Mar	Apr	May	Jun	Jul	Aug	Sep
1		A	0.20			A						
2		0.61A				1.75A						
3			1.90									
4			0.13									
5												
6												
7												
8							0.25	0.25				
9												
10									0.15			0.10
11				A								
12			1.40	1.25A								
13			0.25									
14												
15								0.60				0.50
16												0.13
17			0.90									
18												
19										A		
20										0.60A		
21												
22												
23					0.45							
24												
25												
26												
27				0.25								
28												
29												
30				0.03								
31			0.13									
Totals	0.00	0.61	4.91	1.53	0.45	1.75	0.25	0.85	0.15	0.60	0.00	0.73
										Water Year Total:		11.83

NOTE: All Values are in units of inches, unless otherwise specified.

LEGEND: A - Acculated Total
 E - Estimated
 T - Trace, unmeasurable amount of rain

PRECIPITATION

DAILY RAINFALL SUMMARY

1253 Carson-County Sanitation

Gage Type: Standard Gage

Observation Time: Figures are for a 24-hour period

Latitude 33-48-07

Longitude: 118-16-58

Elevation: 40 Feet

Water Year from 10/01/2014 to 09/30/2015

Day	Oct	Nov	Dec	Jan	Feb	Mar	Apr	May	Jun	Jul	Aug	Sep
1		T	0.02			0.01						
2		0.35	0.02			0.05						
3		0.30	1.48			0.35						
4			0.52									
5			0.01									
6												
7												
8							0.06	A				
9								0.08A				
10												
11				0.63								
12			T	0.49								
13			0.94									
14		T	0.01									
15								0.58				A
16			T					0.11				0.71A
17			0.65									
18			0.14									
19										0.45		
20										0.10E		
21												
22												
23					0.12							
24					0.20							
25												
26							0.03					
27				0.17								
28												
29												
30				0.01								
31			0.18									
Totals	0.00	0.65	3.97	1.30	0.32	0.41	0.09	0.77	0.00	0.55	0.00	0.71
										Water Year Total:		8.77

NOTE: All Values are in units of inches, unless otherwise specified.

LEGEND: A - Acculated Total
 E - Estimated
 T - Trace, unmeasurable amount of rain

PRECIPITATION

DAILY RAINFALL SUMMARY

1254 Long Beach Reclamation Plant

Gage Type: Standard Gage

Observation Time: Figures are for a 24-hour period

Latitude 33-48-11

Longitude: 118-05-20

Elevation: 20 Feet

Water Year from 10/01/2014 to 09/30/2015

Day	Oct	Nov	Dec	Jan	Feb	Mar	Apr	May	Jun	Jul	Aug	Sep
1		0.26	0.15									
2		0.10				0.32						
3			1.05			0.26						
4			0.72									
5												
6												
7												
8							0.80	0.21				
9								0.02				
10												
11				0.46								
12			0.97	0.44								
13			0.49									
14												
15								0.46				0.94
16			0.07					0.20				0.18
17			0.31									
18												
19										0.38		
20										0.22E		
21												
22												
23					0.31							
24												
25												
26							0.04					
27				0.09								
28												
29												
30				0.02								
31			0.06									
Totals	0.00	0.36	3.82	1.01	0.31	0.58	0.84	0.89	0.00	0.60	0.00	1.12
										Water Year Total:		9.53

NOTE: All Values are in units of inches, unless otherwise specified.

LEGEND: A - Acculated Total
 E - Estimated
 T - Trace, unmeasurable amount of rain

Data Revised: April 2016
A - 84

PRECIPITATION

DAILY RAINFALL SUMMARY

1255 Los Coyotes Reclamation Plant

Gage Type: Standard Gage

Observation Time: Figures are for a 24-hour period

Latitude 33-53-05

Longitude: 118-06-24

Elevation: 70 Feet

Water Year from 10/01/2014 to 09/30/2015

Day	Oct	Nov	Dec	Jan	Feb	Mar	Apr	May	Jun	Jul	Aug	Sep
1		0.33	0.70									
2		0.11				0.35						
3			1.09									
4			0.77									
5												
6												
7												
8							0.35	0.15				
9								0.03				
10												
11				0.50								
12			1.00	0.36								
13			0.37									
14												
15								1.02				0.19
16			0.09					0.10				0.20
17			0.61									
18												
19										0.47		
20										0.17E		
21												
22												
23					0.30							
24												
25												
26							0.01					
27				0.13								
28												
29												
30				0.01								
31			T									
Totals	0.00	0.44	4.63	1.00	0.30	0.35	0.36	1.30	0.00	0.64	0.00	0.39
										Water Year Total:		9.41

NOTE: All Values are in units of inches, unless otherwise specified.

LEGEND: A - Acculated Total
 E - Estimated
 T - Trace, unmeasurable amount of rain

PRECIPITATION

DAILY RAINFALL SUMMARY

1256 **South Gate Transfer Station**

Gage Type: Standard Gage

Observation Time: Figures are for a 24-hour period

Latitude 33-56-40

Longitude: 118-09-56

Elevation: 100 Feet

Water Year from 10/01/2014 to 09/30/2015

Day	Oct	Nov	Dec	Jan	Feb	Mar	Apr	May	Jun	Jul	Aug	Sep
1		0.37	0.87			A						
2		0.19				0.63A						
3			1.10									
4			0.83									
5												
6												
7												
8							0.02	0.83				
9					0.01							
10												
11				A								
12			1.50	0.75A								
13												
14												
15								0.60				1.60
16			0.07									
17			0.26									
18												
19										0.47		
20												
21												
22												
23					0.40							
24												
25												
26							0.02					
27				0.15								
28												
29												
30				0.01								
31			0.02	0.02								
Totals	0.00	0.56	4.65	0.93	0.41	0.63	0.04	1.43	0.00	0.47	0.00	1.60
										Water Year Total:		10.72

NOTE: All Values are in units of inches, unless otherwise specified.

LEGEND: A - Acculated Total

 E - Estimated

 T - Trace, unmeasurable amount of rain

Data Revised: April 2016

A - 86

PRECIPITATION

DAILY RAINFALL SUMMARY

1257 San Jose Creek Reclamation Plant

Gage Type: Standard Gage

Observation Time: Figures are for a 24-hour period

Latitude 34-01-55

Longitude: 118-01-16

Elevation: 275 Feet

Water Year from 10/01/2014 to 09/30/2015

Day	Oct	Nov	Dec	Jan	Feb	Mar	Apr	May	Jun	Jul	Aug	Sep
1		0.41	0.43			0.14						
2		0.14				0.41						
3			1.36			0.01						
4			0.47									
5												
6												
7												
8							0.12	0.55				
9								0.07				
10												
11				0.41								
12			0.83	0.03								
13			0.90									
14												
15								0.61				0.55
16												0.38
17			0.27									
18												
19										0.24		
20										0.04E		
21												
22												
23					0.63							
24					T							
25												
26												
27				0.21								
28												
29												
30				0.03						0.07E		
31			0.33									
Totals	0.00	0.55	4.59	0.68	0.63	0.56	0.12	1.23	0.00	0.35	0.00	0.93
										Water Year Total:		9.64

NOTE: All Values are in units of inches, unless otherwise specified.

LEGEND: A - Acculated Total
 E - Estimated
 T - Trace, unmeasurable amount of rain

Data Revised: April 2016
A - 87

PRECIPITATION

DAILY RAINFALL SUMMARY

1258 Puente Hills Landfill

Gage Type: Standard Gage

Observation Time: Figures are for a 24-hour period

Latitude 34-01-35

Longitude: 118-01-49

Elevation: 300 Feet

Water Year from 10/01/2014 to 09/30/2015

Day	Oct	Nov	Dec	Jan	Feb	Mar	Apr	May	Jun	Jul	Aug	Sep
1		A	0.56			A						
2		0.70A				0.55A						
3			1.56									
4			0.57									
5												
6												
7												
8							0.12	0.67				
9								0.09				
10												
11				0.50E								
12			1.15	0.07E								
13			0.73									
14												
15								0.85				0.93
16												0.35
17			0.28									
18												
19										0.40		
20												
21		0.02										
22												
23					0.74							
24												
25												
26												
27				0.24								
28												
29												
30												
31										0.11		
Totals	0.00	0.72	4.85	0.81	0.74	0.55	0.12	1.61	0.00	0.51	0.00	1.28
										Water Year Total:		11.19

NOTE: All Values are in units of inches, unless otherwise specified.

LEGEND: A - Acculated Total
 E - Estimated
 T - Trace, unmeasurable amount of rain

Data Revised: April 2016
A - 88

PRECIPITATION

DAILY RAINFALL SUMMARY

1259 Whittier Narrows Reclamation Plant

Gage Type: Standard Gage

Observation Time: Figures are for a 24-hour period

Latitude 34-03-59

Longitude: 118-03-54

Elevation: 225 Feet

Water Year from 10/01/2014 to 09/30/2015

Day	Oct	Nov	Dec	Jan	Feb	Mar	Apr	May	Jun	Jul	Aug	Sep
1		0.47	0.30									
2		0.04	0.05			0.75						
3			1.18			0.02						
4			0.52									
5												
6												
7												
8							0.12	0.55				
9								0.17				
10												
11				0.58								
12			0.80	0.10								
13			0.33									
14												
15								0.50				0.85
16			0.02					0.05				0.32
17			0.30					T				
18			0.02									
19										0.19		
20										0.04E		
21												
22												
23					0.51							
24												
25												
26												
27				0.18								
28												
29												
30				0.02								
31			0.27							0.03E		
Totals	0.00	0.51	3.79	0.88	0.51	0.77	0.12	1.27	0.00	0.26	0.00	1.17
										Water Year Total:		9.28

NOTE: All Values are in units of inches, unless otherwise specified.

LEGEND: A - Acculated Total
 E - Estimated
 T - Trace, unmeasurable amount of rain

Data Revised: April 2016
A - 89

PRECIPITATION

DAILY RAINFALL SUMMARY

1260 Spadra Landfill

Gage Type: Standard Gage

Observation Time: Figures are for a 24-hour period

Latitude 34-02-36

Longitude: 117-49-50

Elevation: 700 Feet

Water Year from 10/01/2014 to 09/30/2015

Day	Oct	Nov	Dec	Jan	Feb	Mar	Apr	May	Jun	Jul	Aug	Sep
1		A	0.52			A						
2		0.69A				0.39A						
3			1.46									
4			0.47									
5												
6												
7											0.04	
8							0.14	0.42				
9												
10												
11				A								
12			0.95	0.82A								
13			0.56									
14												
15								0.39				0.83
16			0.03									0.45E
17			0.47									
18												
19										A		
20										0.74A		
21												
22												
23					0.52							
24												
25												
26							0.38					
27				0.21								
28												
29												
30				0.01								
31												
Totals	0.00	0.69	4.46	1.04	0.52	0.39	0.52	0.81	0.00	0.74	0.04	1.28
										Water Year Total:		10.49

NOTE: All Values are in units of inches, unless otherwise specified.

LEGEND: A - Acculated Total

E - Estimated

T - Trace, unmeasurable amount of rain

Data Revised: April 2016

A - 90

PRECIPITATION

DAILY RAINFALL SUMMARY

1261 La Canada Reclamation Plant

Gage Type: Standard Gage

Observation Time: Figures are for a 24-hour period

Latitude 34-13-00

Longitude: 118-11-14

Elevation: 1800 Feet

Water Year from 10/01/2014 to 09/30/2015

Day	Oct	Nov	Dec	Jan	Feb	Mar	Apr	May	Jun	Jul	Aug	Sep
1		0.35	0.41			0.12						
2						0.29						
3			1.72			0.08						
4			0.24									
5												
6												
7												
8							0.14	0.09				
9								0.02				
10												
11				0.74								
12			1.50	0.07								
13			0.79									
14												
15								0.96				1.50
16			0.04					0.01				0.57
17			1.35									
18												
19										0.37		
20										1.12E		
21												
22												
23					1.19							
24					0.15							
25												
26							0.17					
27			0.12									
28												
29												
30												
31												
Totals	0.00	0.35	6.05	0.93	1.34	0.49	0.31	1.08	0.00	1.49	0.00	2.07
										Water Year Total:		14.11

NOTE: All Values are in units of inches, unless otherwise specified.

LEGEND: A - Acculated Total
 E - Estimated
 T - Trace, unmeasurable amount of rain

PRECIPITATION

DAILY RAINFALL SUMMARY

1262 Saugus Reclamation Plant

Gage Type: Standard Gage

Observation Time: Figures are for a 24-hour period

Latitude 34-24-48

Longitude: 118-32-23

Elevation: 1150 Feet

Water Year from 10/01/2014 to 09/30/2015

Day	Oct	Nov	Dec	Jan	Feb	Mar	Apr	May	Jun	Jul	Aug	Sep
1		0.41	0.19			0.15						
2		0.01				0.74						
3			2.00			0.21						
4			0.34									
5												
6												
7												
8							0.05	0.07				
9								0.01				
10												0.61
11				1.17								
12			1.82	0.01								
13			0.21									
14												
15								0.49				1.00
16			0.29									0.06
17			0.37									
18												
19						0.01				0.80		
20										0.23E		
21												
22												
23					0.45							
24												
25												
26												
27				0.03								
28												
29												
30				0.08								
31												
Totals	0.00	0.42	5.22	1.29	0.45	1.11	0.05	0.57	0.00	1.03	0.00	1.67
Water Year Total:												11.81

NOTE: All Values are in units of inches, unless otherwise specified.

LEGEND: A - Acculated Total
 E - Estimated
 T - Trace, unmeasurable amount of rain

Data Revised: April 2016
 A - 92

PRECIPITATION

DAILY RAINFALL SUMMARY

1263 **Valencia Reclamation Plant**

Gage Type: Standard Gage

Observation Time: Figures are for a 24-hour period

Latitude 34-25-55

Longitude: 118-37-13

Elevation: 1000 Feet

Water Year from 10/01/2014 to 09/30/2015

Day	Oct	Nov	Dec	Jan	Feb	Mar	Apr	May	Jun	Jul	Aug	Sep
1		0.42	0.10			0.17						
2		0.02	0.05			0.49						
3			1.92			0.22						
4			0.07									
5												
6												
7												
8							0.15	0.23				
9												
10												0.18
11				1.23								
12			1.61	0.01								
13			0.16									
14												0.05
15								0.65				1.07
16			0.10									0.16
17			0.27									
18			0.01									
19										0.72		
20										0.32E		
21												
22												
23					0.50							
24												
25												
26							0.07					
27				0.03								
28												
29												
30				0.04								
31			0.01									
Totals	0.00	0.44	4.30	1.31	0.50	0.88	0.22	0.88	0.00	1.04	0.00	1.46
Water Year Total:												11.03

NOTE: All Values are in units of inches, unless otherwise specified.

LEGEND: A - Acculated Total
 E - Estimated
 T - Trace, unmeasurable amount of rain

Data Revised: April 2016
A - 93

PRECIPITATION

DAILY RAINFALL SUMMARY

1264 Calabasas Landfill

Gage Type: Standard Gage

Observation Time: Figures are for a 24-hour period

Latitude 34-08-25

Longitude: 118-42-35

Elevation: 800 Feet

Water Year from 10/01/2014 to 09/30/2015

Day	Oct	Nov	Dec	Jan	Feb	Mar	Apr	May	Jun	Jul	Aug	Sep
1		A	0.96			A						
2		0.43A				1.00A						
3			1.95			0.10						
4			0.25									
5												
6												
7												
8					0.13		0.04	0.04				
9												
10									0.06			
11				A								
12			1.25	1.05A								
13			0.63									
14		0.02										
15								0.31				0.98
16			0.10									
17			0.18									
18												
19										A		
20										1.05A		
21		0.02										
22												
23					0.24							
24					0.08							
25												
26												
27				0.23								
28												
29												
30				0.05								
31												
Totals	0.00	0.47	5.32	1.33	0.45	1.10	0.04	0.35	0.06	1.05	0.00	0.98
										Water Year Total:		11.15

NOTE: All Values are in units of inches, unless otherwise specified.

LEGEND: A - Acculated Total
 E - Estimated
 T - Trace, unmeasurable amount of rain

Data Revised: April 2016
A - 94

PRECIPITATION

DAILY RAINFALL SUMMARY

1265 Scholl Canyon Landfill

Gage Type: Standard Gage

Observation Time: Figures are for a 24-hour period

Latitude 34-08-38

Longitude: 118-11-07

Elevation: 1000 Feet

Water Year from 10/01/2014 to 09/30/2015

Day	Oct	Nov	Dec	Jan	Feb	Mar	Apr	May	Jun	Jul	Aug	Sep
1		0.41	0.21			A						
2		0.02				0.70A						
3			1.34			0.01						
4			0.25						0.01			
5												
6												
7												
8							0.18	0.06				
9					0.04							
10												
11				A								
12			1.25	0.60A					0.04			
13			1.08									
14												
15								1.22				1.71
16			0.04					0.02				0.32
17			0.81									
18												
19										A		
20										0.70A		
21												
22												
23					0.52							
24					0.03							
25												
26							0.31					
27				0.10								
28												
29												
30												
31			0.16	0.03								
Totals	0.00	0.43	5.14	0.73	0.59	0.71	0.49	1.30	0.05	0.70	0.00	2.03
										Water Year Total:		12.17

NOTE: All Values are in units of inches, unless otherwise specified.

LEGEND: A - Acculated Total
 E - Estimated
 T - Trace, unmeasurable amount of rain

PRECIPITATION

DAILY RAINFALL SUMMARY

1266 **Mission Canyon Landfill**

Gage Type: Standard Gage

Observation Time: Figures are for a 24-hour period

Latitude 34-08-40

Longitude: 118-28-45

Elevation: 1150 Feet

Water Year from 10/01/2014 to 09/30/2015

Day	Oct	Nov	Dec	Jan	Feb	Mar	Apr	May	Jun	Jul	Aug	Sep
1		A	2.50			A						
2		0.50A				1.25A						
3			2.02									
4			0.25									
5												
6												
7												
8								0.03				
9					0.02							
10												
11				A								
12			1.45	1.55A								
13												
14												
15								0.27				1.28
16			0.15					0.03				
17			1.30									
18												
19						0.01				A		
20										0.55A		
21												
22												
23					0.38							
24												
25												
26							0.03					
27				0.15								
28												
29												
30				0.14								
31												
Totals	0.00	0.50	7.67	1.84	0.40	1.26	0.03	0.33	0.00	0.55	0.00	1.28
										Water Year Total:		13.86

NOTE: All Values are in units of inches, unless otherwise specified.

LEGEND: A - Acculated Total

 E - Estimated

 T - Trace, unmeasurable amount of rain

Data Revised: April 2016

A - 96

PRECIPITATION

DAILY RAINFALL SUMMARY

1267 **Lancaster Reclamation Plant**

Gage Type: Standard Gage

Observation Time: Figures are for a 24-hour period

Latitude 34-46-38

Longitude: 118-09-11

Elevation: 2302 Feet

Water Year from 10/01/2014 to 09/30/2015

Day	Oct	Nov	Dec	Jan	Feb	Mar	Apr	May	Jun	Jul	Aug	Sep
1		0.23				0.05						
2		0.04				0.01						
3			0.85									
4			0.07									
5												
6												
7												
8								0.13				
9												
10												
11				0.65								
12			0.05	0.10								
13			0.16									
14												
15								0.08				0.70
16			0.02									0.14
17			0.20									
18												
19										0.50		
20										0.35E		
21												
22												
23					0.36							
24												
25												
26												
27				0.04								
28												
29												
30				0.03								
31												
Totals	0.00	0.27	1.35	0.82	0.36	0.06	0.00	0.21	0.00	0.85	0.00	0.84
										Water Year Total:		4.76

NOTE: All Values are in units of inches, unless otherwise specified.

LEGEND: A - Acculated Total
 E - Estimated
 T - Trace, unmeasurable amount of rain

Data Revised: April 2016
A - 97

PRECIPITATION

DAILY RAINFALL SUMMARY

1268 Palmdale Reclamation Plant

Gage Type: Standard Gage

Observation Time: Figures are for a 24-hour period

Latitude 34-35-30

Longitude: 118-05-10

Elevation: 2565 Feet

Water Year from 10/01/2014 to 09/30/2015

Day	Oct	Nov	Dec	Jan	Feb	Mar	Apr	May	Jun	Jul	Aug	Sep
1		0.18				0.03						
2			0.01			0.01						
3			1.15									
4			0.09									
5												
6												
7												
8								0.01				
9												
10												
11				0.55								
12			0.75	0.16								
13			0.36									
14												
15								0.06				0.38
16			0.01									0.07
17			0.23									
18												
19						0.05				0.51		
20										0.37E		
21												
22												
23					0.32							
24												
25												
26								0.10				
27				0.03								
28					0.01							
29												
30				0.08						0.03		
31										0.01		
Totals	0.00	0.18	2.60	0.82	0.33	0.09	0.10	0.07	0.00	0.92	0.00	0.45
										Water Year Total:		5.56

NOTE: All Values are in units of inches, unless otherwise specified.

LEGEND: A - Acculated Total
 E - Estimated
 T - Trace, unmeasurable amount of rain

Data Revised: April 2016
A - 98

PRECIPITATION

DAILY RAINFALL SUMMARY

1271 Pomona Waste Reclamation Plant

Gage Type: Standard Gage

Observation Time: Figures are for a 24-hour period

Latitude 34-03-18

Longitude: 117-47-34

Elevation: 786 Feet

Water Year from 10/01/2014 to 09/30/2015

Day	Oct	Nov	Dec	Jan	Feb	Mar	Apr	May	Jun	Jul	Aug	Sep
1		0.57	0.53			0.12						
2		0.19	0.02			0.20						
3			1.73			0.03						
4			0.48									
5												
6												
7												
8							0.18	0.48				
9								0.01				
10												
11				0.62								
12			0.87	0.34								
13			0.84									
14												
15								0.32				0.61
16			0.02					0.02				0.72
17			0.65									
18			0.01									
19										0.38		
20										0.33E		
21												
22												
23					0.59							
24					0.02							
25												
26							0.31					
27				0.22								
28												
29												
30				0.01								
31			0.15									
Totals	0.00	0.76	5.30	1.19	0.61	0.35	0.49	0.83	0.00	0.71	0.00	1.33
										Water Year Total:		11.57

NOTE: All Values are in units of inches, unless otherwise specified.

LEGEND: A - Acculated Total
 E - Estimated
 T - Trace, unmeasurable amount of rain

Data Revised: April 2016
A - 99

PRECIPITATION

DAILY RAINFALL SUMMARY

1274 Whittier - Valna Drive

Gage Type: Standard Private

Observation Time: Figures are for a 24-hour period

Latitude 33-57-39

Longitude: 118-01-10

Elevation: 255 Feet

Water Year from 10/01/2014 to 09/30/2015

Day	Oct	Nov	Dec	Jan	Feb	Mar	Apr	May	Jun	Jul	Aug	Sep
1		0.45	0.87									
2		0.05	0.02			0.17						
3			1.16			0.01						
4			0.71									
5												
6												
7											T	
8					0.02		0.10	0.85				
9								0.10	T			
10									0.02			
11				0.52								
12			1.17	0.11								
13			0.12									
14												
15								0.49				0.76
16			0.02					0.08				0.38
17			0.46									
18												
19										0.26		
20										0.20		
21		T										
22												
23					0.39							
24												
25												
26												
27				0.20								
28												
29												
30				0.02								
31			0.08									
Totals	0.00	0.50	4.61	0.85	0.41	0.18	0.10	1.52	0.02	0.46	0.00	1.14
										Water Year Total:		9.79

NOTE: All Values are in units of inches, unless otherwise specified.

LEGEND: A - Acculated Total
 E - Estimated
 T - Trace, unmeasurable amount of rain

Data Revised: April 2016
 A - 100

PRECIPITATION

DAILY RAINFALL SUMMARY

1290 Woodland Hills

Gage Type: Standard Private

Observation Time: Figures are for a 24-hour period

Latitude 34-10-39

Longitude: 118-36-45

Elevation: 873 Feet

Water Year from 10/01/2014 to 09/30/2015

Day	Oct	Nov	Dec	Jan	Feb	Mar	Apr	May	Jun	Jul	Aug	Sep
1		0.34	0.02			0.68						
2			1.40			0.19						
3			0.62			0.02						
4												
5												
6												
7					0.07		0.05					
8												
9									0.02			
10				0.40								
11				0.85								
12			1.60									
13		0.05										
14								0.05				
15			0.04					0.10				0.66
16			0.20									
17			0.17									
18										0.40		
19										0.28		
20										0.08		
21		0.01										
22					0.26							
23					0.05							
24												
25												
26				0.05								
27				0.29								
28												
29												
30		0.61		0.02								
31												
Totals	0.00	1.01	4.05	1.61	0.38	0.89	0.05	0.15	0.02	0.76	0.00	0.66
										Water Year Total:		9.58

NOTE: All Values are in units of inches, unless otherwise specified.

LEGEND: A - Acculated Total
 E - Estimated
 T - Trace, unmeasurable amount of rain

*Data Revised: April 2016
 A - 101*

APPENDIX B

HYDROLOGIC REPORT 2014 – 2015

RUNOFF - STREAM GAGING STATION INFORMATION

RUNOFF – STREAM GAGING STATION INFORMATION

ALHAMBRA WASH

Above Klingerman Street

STATION NO. F81D-R

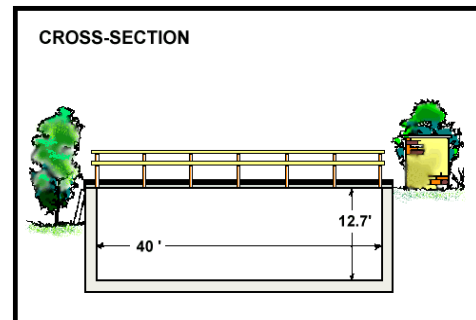
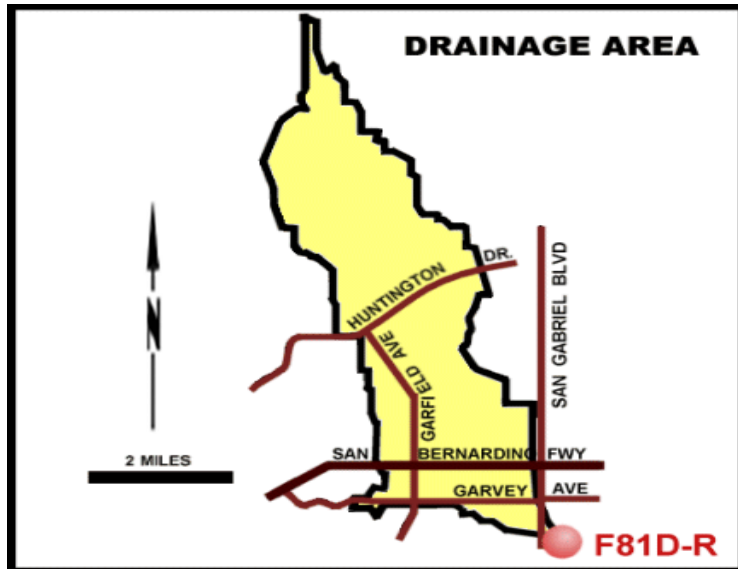

RECORDER - 5 min. interval data logger.

METHOD OF MEASUREMENT - Wading or from footbridge.

DRAINAGE AREA - 15.2 square miles.

LOCATION - 250 feet above Klingerman Street and 2650 feet below Garvey Avenue, City of Rosemead

REGULATION - None.

DIVERSION - None.

CHANNEL - Concrete, rectangular in section, 40.0 feet wide by 12.7 feet deep.

CONTROL - Channel forms control.

LENGTH OF RECORD - At Station F81-R, January 14, 1930 to September 30, 1934; at Station F81B-R, October 1, 1934 to February 25, 1935; at Station F81C-R February 25, 1935 to April 27, 1936; at Station F81B-R April 27, 1936 to May 22, 1936; at Station F81D-R, September 2, 1936 to date.

REMARKS - None.

RUNOFF – STREAM GAGING STATION INFORMATION

ARCADIA WASH

Below Grand Ave

STATION NO. F317-R

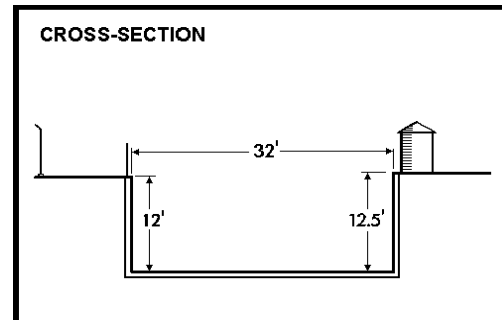
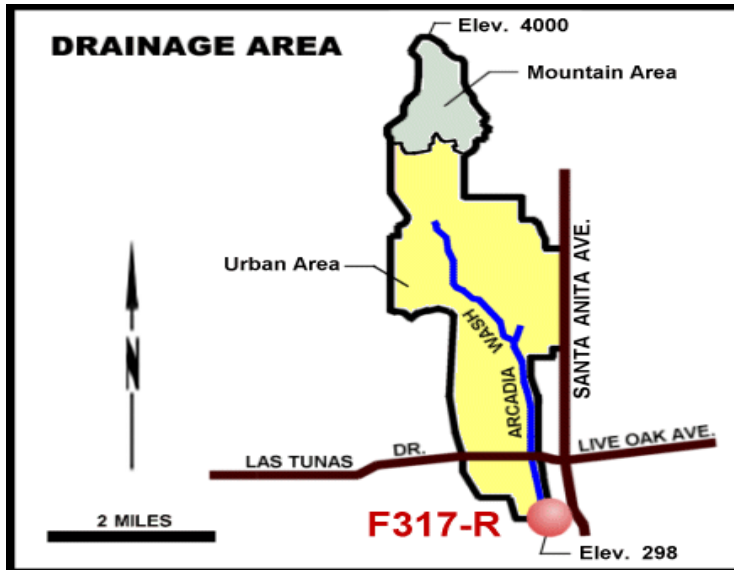

RECORDER - 5 min. interval data logger.

METHOD OF MEASUREMENT - Low flows measured by wading. High flows measured from upstream side of Grand Avenue bridge.

DRAINAGE AREA - 8.5 square miles.

LOCATION - On the west wall of Arcadia Wash about 75 feet downstream from centerline of Grand Avenue.

REGULATION - Several debris basins located upstream.

DIVERSION - None.

CHANNEL - Concrete, rectangular section, 32.0 feet wide by 12.0 feet deep.

CONTROL

LENGTH OF RECORD - December 12, 1955 to date.

REMARKS - None.

RUNOFF – STREAM GAGING STATION INFORMATION

ARROYO SECO

Below Devil's Gate Dam

STATION NO. F277-R

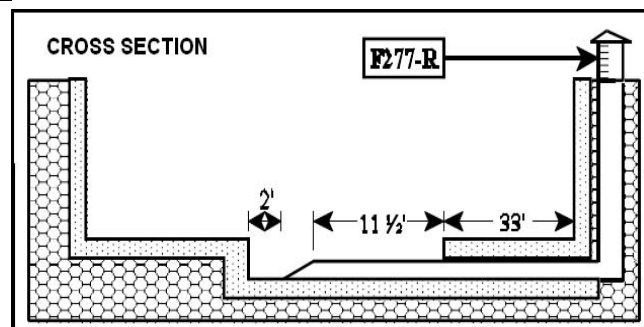
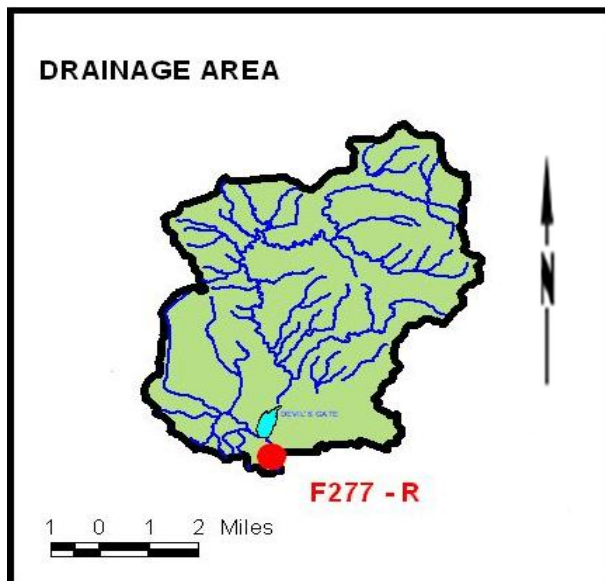

RECORDER - 5 min. interval data logger.

METHOD OF MEASUREMENT - Wading

DRAINAGE AREA - 32.5 square miles.

LOCATION - On the east side of the channel about 0.5 mile below Devil's Gate Dam, and about 0.5 mile above Washington Street, Pasadena. Elevation of Gage is about 926 feet.

REGULATION - Flow regulated by Devil's Gate Dam and Pasadena Water Department's Gated Diversion into channel above station.

DIVERSION - Pasadena Water Department diverts flow approximately two miles above Devil's Gate Dam for domestic use. Flow may be diverted to channel between Devil's Gate Dam and station from Pasadena Water Department.

CHANNEL - sand and gravel, natural section.

CONTROL - Channel forms control.

LENGTH OF RECORD - At Station P277-R, November 30, 1942 to September 30, 1980. At station F277, October 01, 1980 to date.

REMARKS - Located, constructed, and operated by the Pasadena Water Department January 1940. The operation taken over by the Los Angeles County Flood Control District November 30, 1942 in cooperation with the Pasadena Water Department.

RUNOFF – STREAM GAGING STATION INFORMATION

BALLONA CREEK

Above Sawtelle Blvd

STATION NO. F38C-R

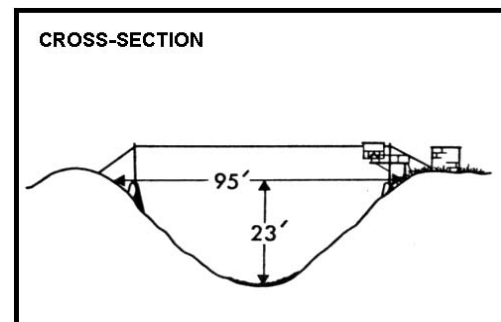
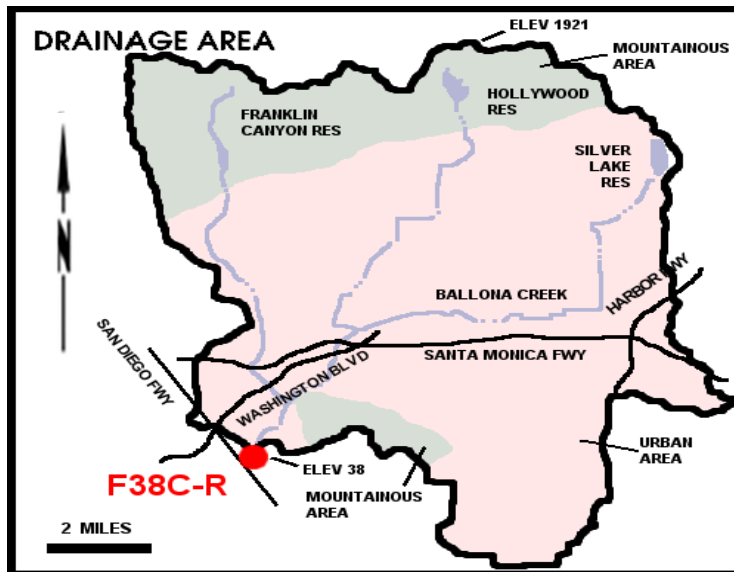

RECORDER - Continuous water stage.

METHOD OF MEASUREMENT - Wading

DRAINAGE AREA - 88.6 square miles.

LOCATION - 530.0 feet above Sawtelle Boulevard, 1.5 miles southwest of Culver City.

REGULATION - Stone Canyon Reservoir prior to January, 1951. Upper and Lower Franklin Canyon Reservoir, Hollywood Reservoir, and Silver Lake Reservoir.

DIVERSION - None.

CHANNEL - Concrete rubble, trapezoidal in section.

CONTROL - Channel forms control.

LENGTH OF RECORD - At station F38-R, February 27, 1928 to April 27, 1936; at Station F38B-R, May 14, 1936 to August 10, 1967; at Station F38C-R, August 10, 1967 to date.

REMARKS - None.

RUNOFF – STREAM GAGING STATION INFORMATION

BIG DALTON CREEK

Below Big Dalton Dam

STATION NO. F120B-R

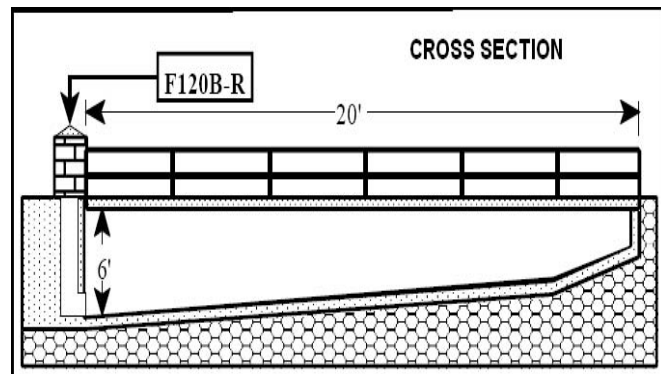
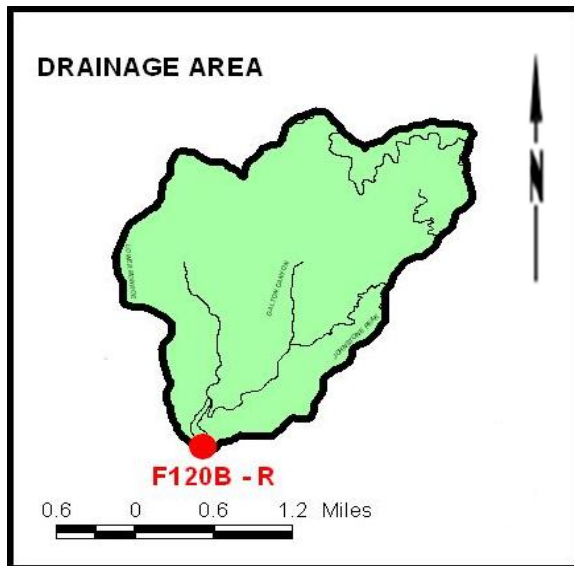

RECORDER - Continuous water stage.

METHOD OF MEASUREMENT - Wading

DRAINAGE AREA - 4.8 square miles.

LOCATION - On the left (southeast) bank about 400 feet below the old toe wall on the downstream side of Big Dalton Dam and about 5 miles northeast of Glendora. Elevation of zero gage height is 1539.63 feet.

REGULATION - 4.5 square miles regulated by Big Dalton Dam. 0.3 square miles unregulated flow from KERIL Canyon.

DIVERSION - None.

CHANNEL - Sand and gravel, natural section.

CONTROL - Concrete stabilizer.

LENGTH OF RECORD - Reservoir outflow records from October 1929 to June 3, 1940, recorder records from June 3, 1940 to September 30, 1955, from October 1, 1955 to date.

REMARKS - None.

RUNOFF – STREAM GAGING STATION INFORMATION

BIG ROCK CREEK

Upstream from Pallett Creek

STATION NO. F394-R

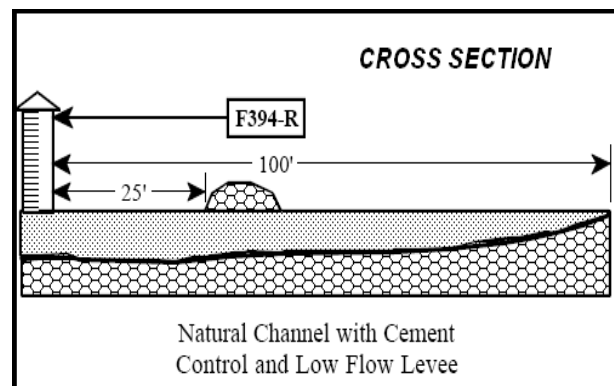
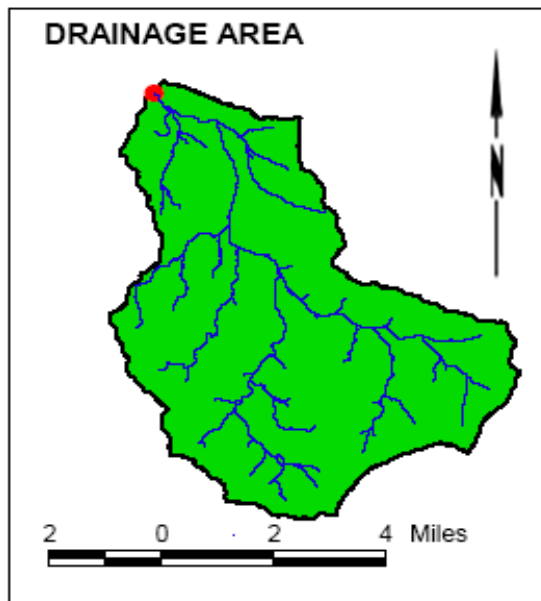

RECORDER - Continuous water stage.

METHOD OF MEASUREMENT - Wading or from stream gaging.

DRAINAGE AREA - 34.3 square miles.

LOCATION - 300 feet upstream from confluence with Pallett Creek, and 1.4 miles northwest of Valyermo.

REGULATION - None.

DIVERSION - None.

CHANNEL - Natural flow affected by pumping along creek.

CONTROL - Concrete stabilizer.

LENGTH OF RECORD - October 1986 to date.

REMARKS - None.

RUNOFF – STREAM GAGING STATION INFORMATION

BIG TUJUNGA CREEK

Below Big Tujunga Dam

STATION NO. F168B-R

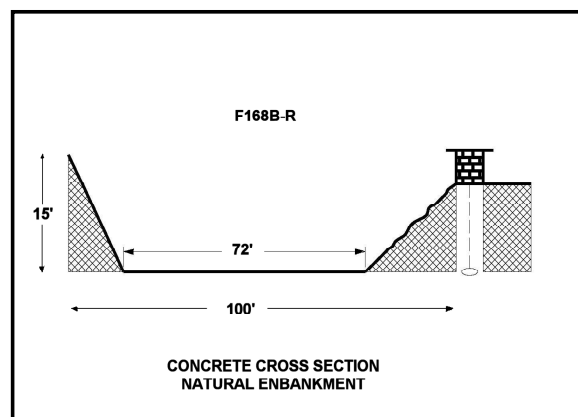
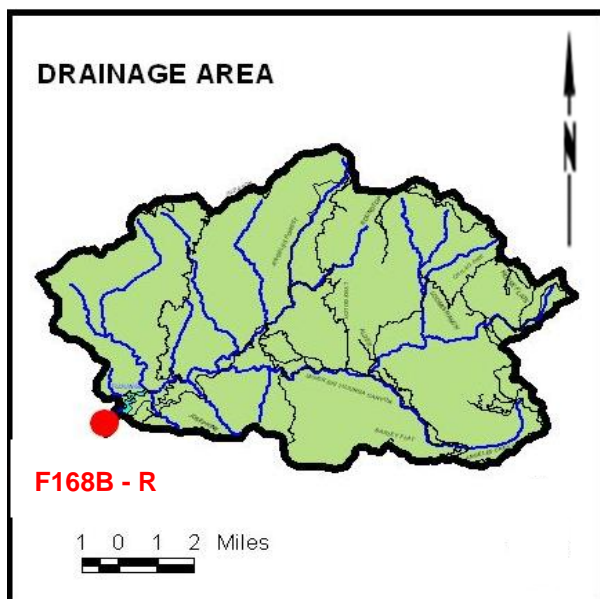

RECORDER - Continuous water stage.

METHOD OF MEASUREMENT - Wading

DRAINAGE AREA - 82.3 square miles.

LOCATION - On the right (northwest) bank, 2800 feet below Big Tujunga Dam and about 12 miles northeast of Sunland, Elevation of zero gage height is 2063.34 feet.

REGULATION - Flow regulated by Big Tujunga Dam.

DIVERSION - None.

CHANNEL - Sand, gravel, and boulders.

CONTROL - No artificial Control.

LENGTH OF RECORD - Stream measurements from December 8, 1931 to November 7, 1932 and January 20, 1938 to May 29, 1938; recorder records from November 8, 1932 to January 13, 1938 and from May 31, 1938 to September 30, 1955, from September 30, 1955 to date.

REMARKS - No data published from Water Years 2008- 09 thru 2011- 12 due to rehabilitation project.

RUNOFF – STREAM GAGING STATION INFORMATION

BOUQUET CREEK

Above Bouquet Canyon Road

STATION NO. F377B-R

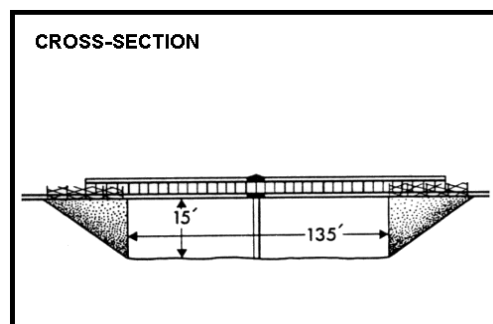
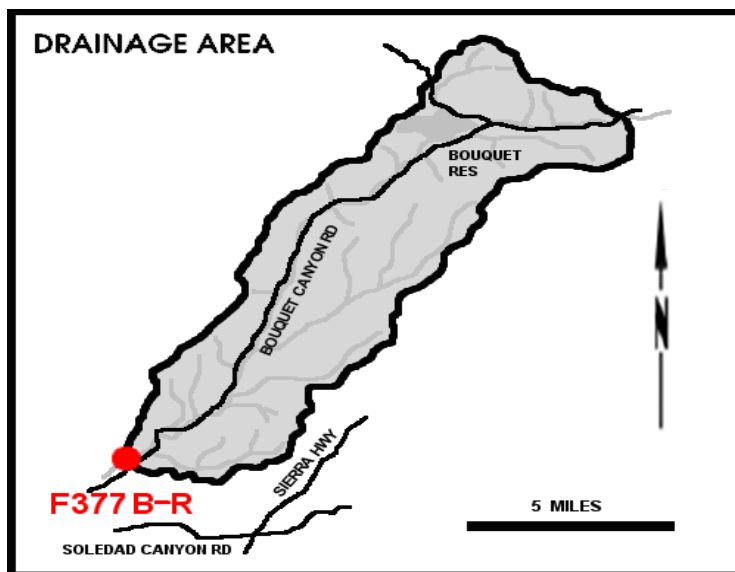

RECORDER - Continuous water stage.

METHOD OF MEASUREMENT - Wading or from bridge.

DRAINAGE AREA - 60.9 square miles.

LOCATION - In San Francisco Grant, on left bank, 500 feet upstream from Bouquet Canyon Road bridge, 1.5 miles northeast of Saugus, and 1.7 miles downstream from Haskell Canyon Creek

REGULATION - Bouquet Reservoir.

DIVERSION - None.

CHANNEL - Concrete sides with natural bottom, trapezoidal in section.

CONTROL - Concrete stabilizer.

LENGTH OF RECORD - At station F377-R, October 11, 1967 to December 19, 2001; at station F377B-R, January 4, 2002 to date.

REMARKS - Records fair except for estimated daily discharges, which are poor. Partial regulation by Bouquet Reservoir, capacity 36,500 acre-feet, principally used as equalizing reservoir to city of Los Angeles aqueduct. Some pumping of wells for irrigation upstream from station.

RUNOFF – STREAM GAGING STATION INFORMATION

BRADBURY CHANNEL

Below Central Avenue

STATION NO. F329-R

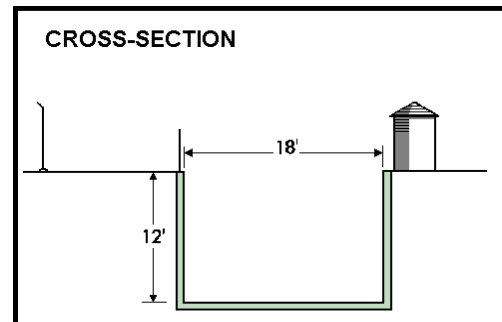
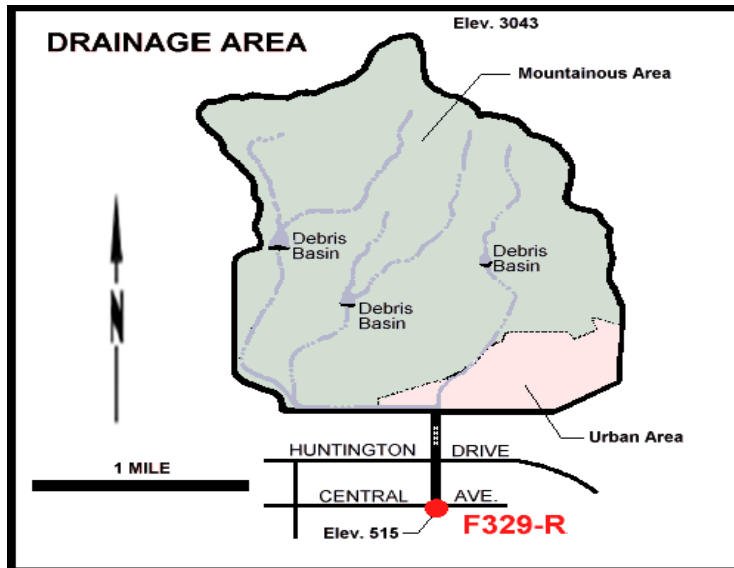

RECORDER - 5 min. interval data logger.

METHOD OF MEASUREMENT - Low flows measured by wading. High flows measured from footbridge four feet downstream from recorder.

DRAINAGE AREA - 3.3 square miles.

LOCATION - On the east wall of Bradbury Channel, 200 feet downstream from the centerline of Central Avenue, one mile east of Duarte.

REGULATION - Two debris basins located upstream.

DIVERSION - None.

CHANNEL - Rectangular concrete, 18 feet wide, 12 feet deep.

CONTROL - Channel forms control.

LENGTH OF RECORD - June 14, 1957 to date.

REMARKS - None.

RUNOFF – STREAM GAGING STATION INFORMATION

BRANFORD STREET CHANNEL

Below Sharp Avenue

STATION NO. F342-R

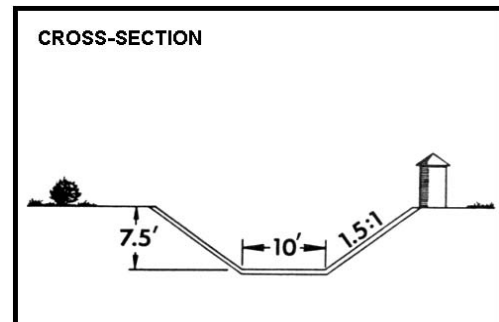
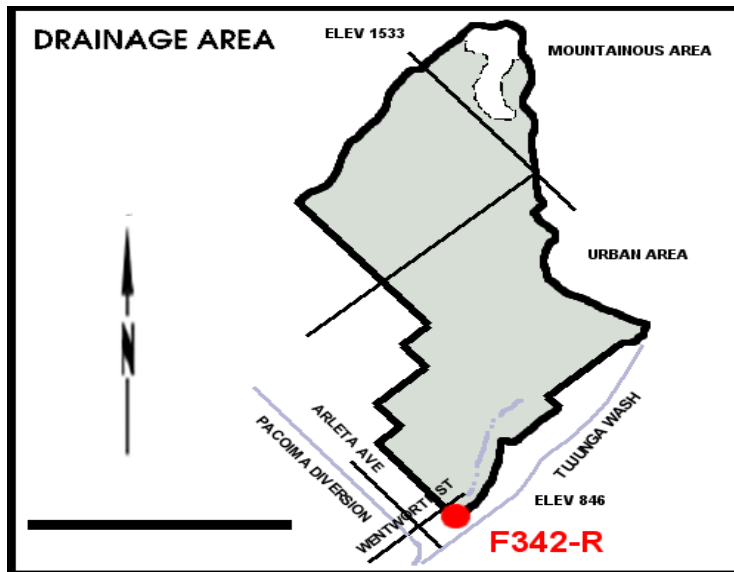

RECORDER - Continuous water stage.

METHOD OF MEASUREMENT - Low flows measured by wading.

DRAINAGE AREA - 5.01 square miles.

LOCATION - On the south bank of channel, 125 feet downstream from Sharp Avenue, about 3.6 miles south of San Fernando.

REGULATION - Flow from Lopez Creek is diverted to Hansen Dam at the mouth of Lopez Canyon.

DIVERSION - None.

CHANNEL - Trapezoidal, 10 feet wide at bottom and 7.5 feet deep with 1.5 to 1 side slopes.

CONTROL - Channel forms control.

LENGTH OF RECORD - January 12, 1962 to date.

REMARKS - None.

RUNOFF – STREAM GAGING STATION INFORMATION

BURBANK WESTERN STORM DRAIN

At Riverside Dr.

STATION NO. E285-R

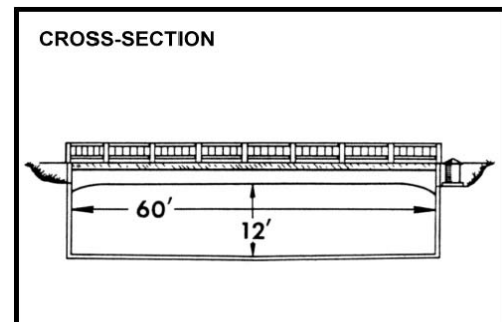
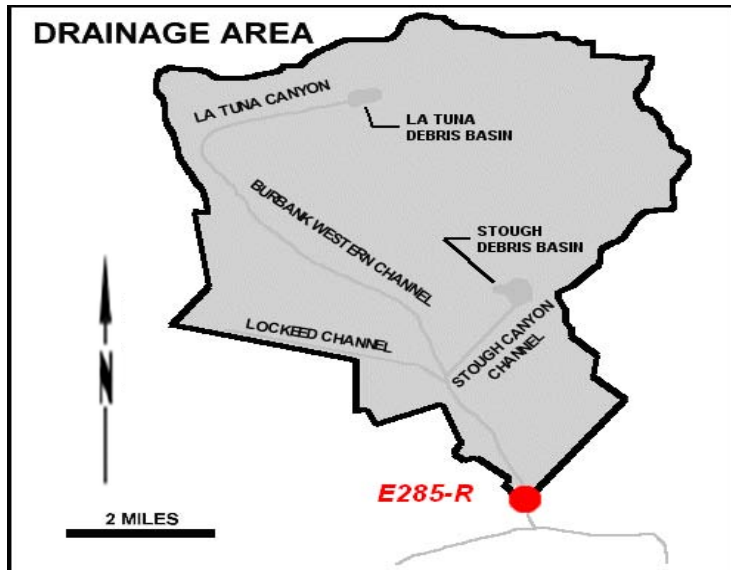

RECORDER - Continuous water stage.

METHOD OF MEASUREMENT - Wading or from bridge.

DRAINAGE AREA - 25.0 square miles.

LOCATION - 20 feet upstream from Riverside Drive, Glendale.

REGULATION - Several debris basins on tributaries.

DIVERSION - None.

CHANNEL - Concrete, rectangular section.

CONTROL - Channel forms control.

LENGTH OF RECORD - October 1, 1949 to date.

REMARKS - Operated in cooperation with the USCE.

RUNOFF – STREAM GAGING STATION INFORMATION

COMPTON CREEK

Near Greenleaf Drive.

STATION NO. F37B-R

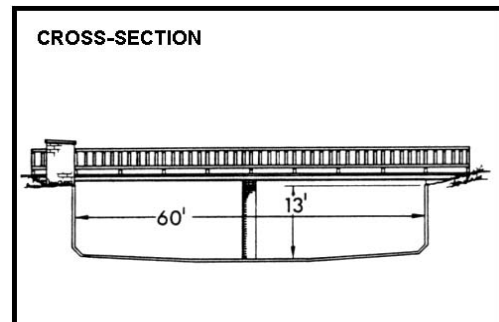
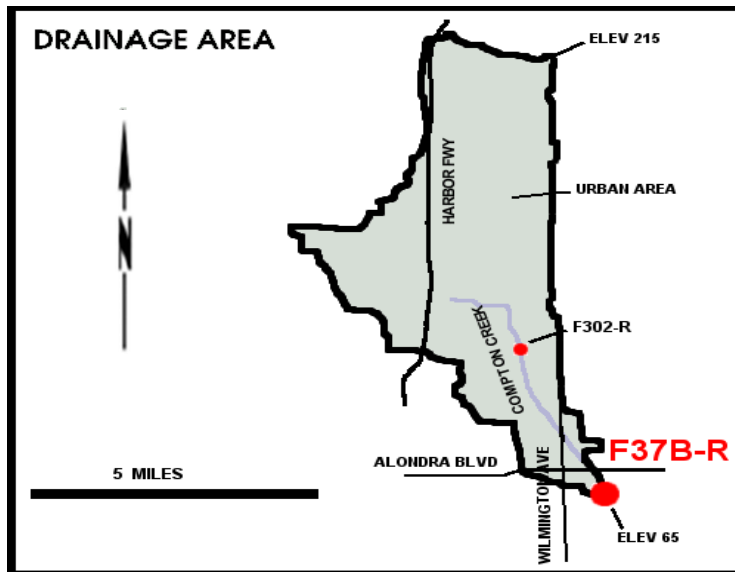

RECORDER - Continuous water stage.

METHOD OF MEASUREMENT - Wading or from bridge.

DRAINAGE AREA - 22.6 square miles.

LOCATION - 120.0 feet above Greenleaf Boulevard, 1.5 miles south west of Compton.

REGULATION - None.

DIVERSION - None.

CHANNEL - Concrete, rectangular in section, 60 feet wide by 13 feet deep.

CONTROL - Channel forms control.

LENGTH OF RECORD - At Station F37-R, January 22, 1928 to June 9, 1938; at Station F37B-R, October 3, 1938 to date.

REMARKS - None.

RUNOFF – STREAM GAGING STATION INFORMATION

COYOTE CREEK

Below Spring Street.

STATION NO. F354-R

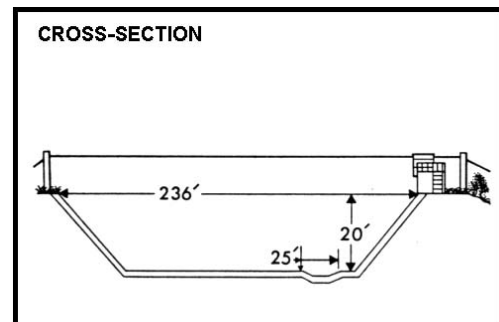
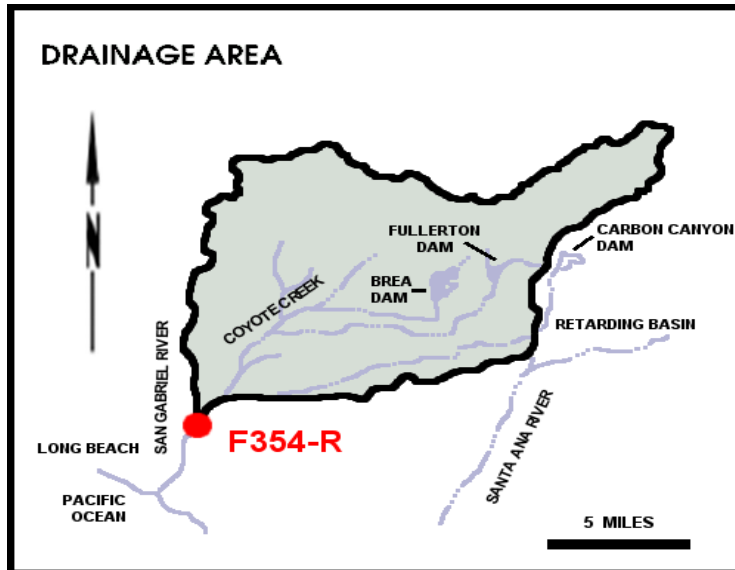

RECORDER - Continuous water stage.

METHOD OF MEASUREMENT - Wading or from cable car.

DRAINAGE AREA - 185.0 square miles.

LOCATION - 241.0 feet below Spring Street, 5.7 miles northeast of Long Beach.

REGULATION - Partially regulated by Fullerton Dam, Brea Dam, and Carbon Canyon Dam.

DIVERSION - None.

CHANNEL - Concrete, trapezoidal in section.

CONTROL - Channel forms control.

LENGTH OF RECORD - December 19, 1936 to date.

REMARKS - Previous gaging stations for record correlation: Station F41-S, December 1, 1928 to January 14, 1930; Station F41-R, January 14, 1930 to October 30, 1936; Station F41B-R, October 30, 1936 to February 17, 1937; Station F41C-R, February 18, 1937 to February 8, 1956; Station F320-R, February 9, 1956 to July 2, 1965; At Station F354-R October 1, 1963 to date.

RUNOFF – STREAM GAGING STATION INFORMATION

DALTON WASH At Merced Avenue STATION NO. F274B-R

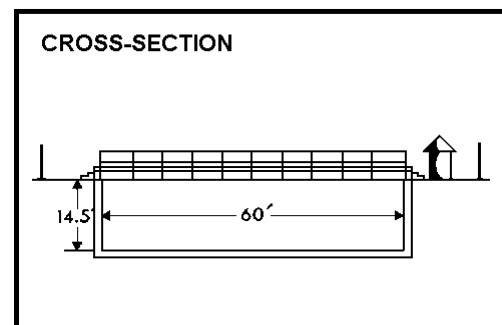
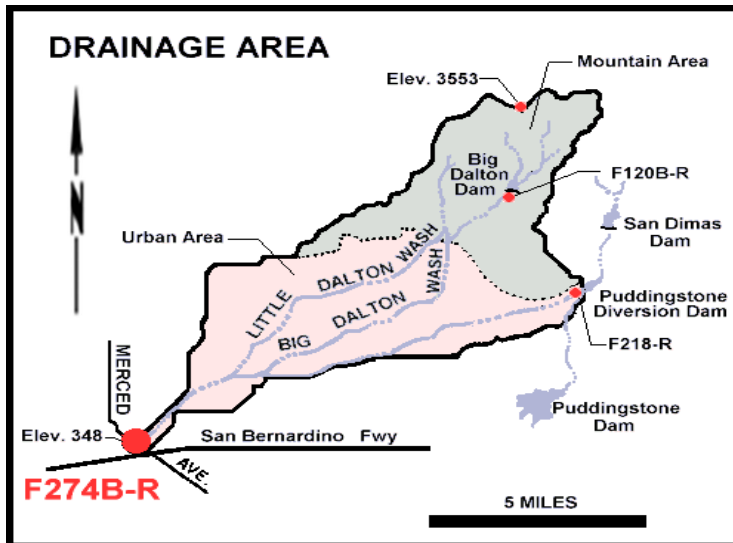

RECORDER - 5 min. interval data logger.

METHOD OF MEASUREMENT - Low flows measured by wading. High flows measured from footbridge 100 feet from station.

DRAINAGE AREA - 35.95 square miles.

LOCATION - On the west bank and upstream of Merced Avenue about 150 feet, about one-half mile above the junction with Walnut Wash and about one mile south of Baldwin Park.

REGULATION - Partly regulated by Big Dalton Dam, San Dimas Dam, Puddingstone Diversion Dam, Big Dalton Spreading Grounds, Little Dalton Spreading Grounds, Big Dalton Debris Basin, Little Debris Basin and Irwindale Spreading Grounds.

DIVERSION - None.

CHANNEL - Concrete, rectangular section.

CONTROL - Channel forms control.

LENGTH OF RECORD - At station F274, October 1940 to September 1958; at station F274B-R, October 1, 1958 to date.

REMARKS - Flow may include imported water originating at San Dimas.

RUNOFF – STREAM GAGING STATION INFORMATION

EATON WASH

At Loftus Drive.

STATION NO. F318-R

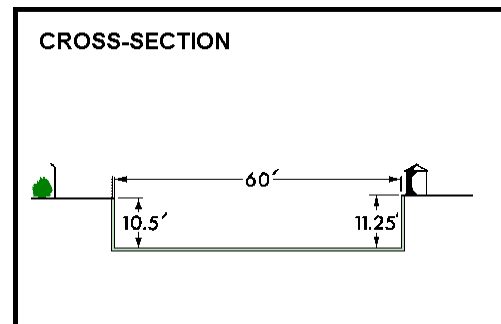
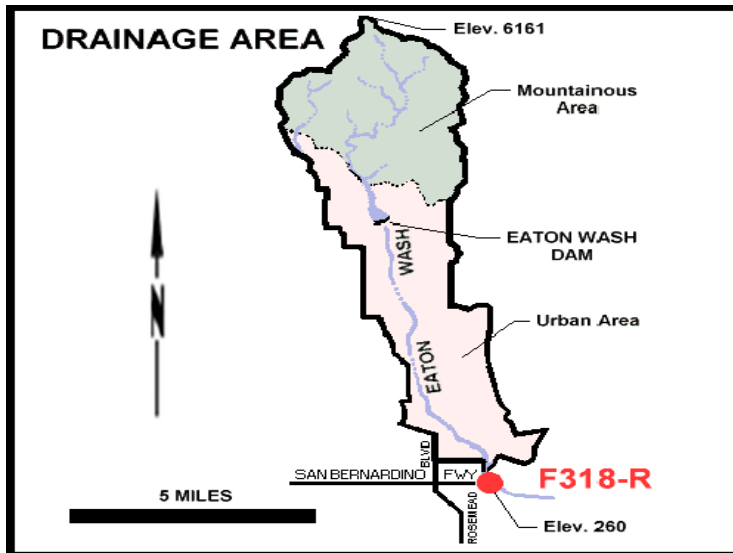

RECORDER - 5 min. interval data logger.

METHOD OF MEASUREMENT - Low flows measured by wading. High flows measured from upstream side of East Loftus Drive bridge.

DRAINAGE AREA - 22.8 square miles.

LOCATION - On the west wall of the channel 52 feet above the centerline of East Loftus Drive bridge, 1.3 miles west of El Monte.

REGULATION - Partly regulated by Eaton Dam.

DIVERSION - The Pasadena Water Department diverts some water just above the mouth of Eaton Canyon. The Flood Control District Diverts water to spreading grounds below Eaton Dam and below Huntington Drive.

CHANNEL - Rectangular concrete, 60 feet wide, 11.3 feet.

CONTROL - Channel forms control.

LENGTH OF RECORD - 1956 to date.

REMARKS - None.

RUNOFF – STREAM GAGING STATION INFORMATION

EATON WASH

Below Eaton Wash Dam

STATION NO. F271-R

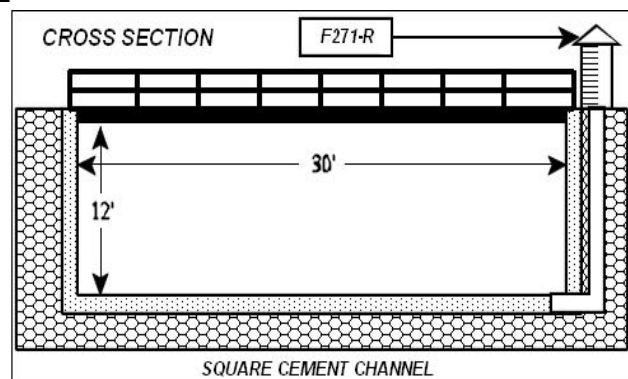
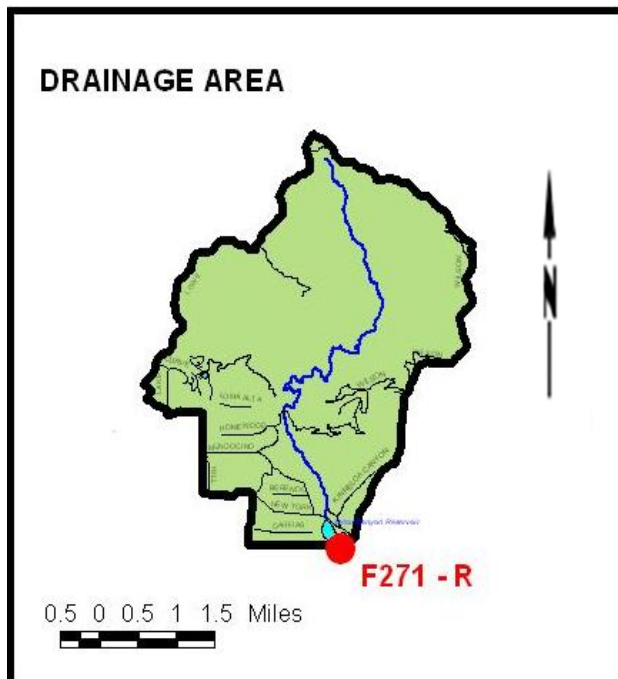

RECORDER - Continuous water stage.

METHOD OF MEASUREMENT - Wading

DRAINAGE AREA - 12.4 square miles.

LOCATION - On the right (west) bank of the concrete outlet channel 190 feet below the beginning of the open section at the base of Eaton Wash Dam. Elevation of gage about 840 feet.

REGULATION - Flow regulated by Eaton Wash Dam.

DIVERSION - Pasadena Water Department diverts flow above the mouth of Eaton Canyon.

CHANNEL - Concrete, rectangular section.

CONTROL - Channel forms control.

LENGTH OF RECORD - Reservoir outflow records from February 2, 1937 to October 10, 1940. Recorder records from October 10, 1940 to September 30, 1955, from September 30, 1955 to date.

REMARKS - None.

RUNOFF – STREAM GAGING STATION INFORMATION

FISH CREEK

Above mouth of canyon.

STATION NO. U7-R

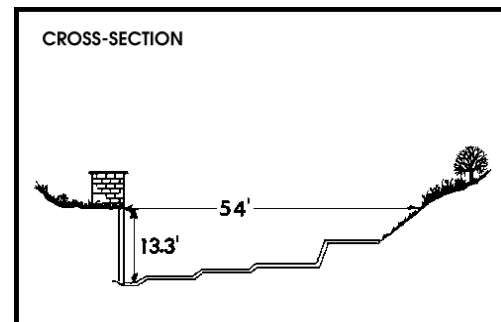
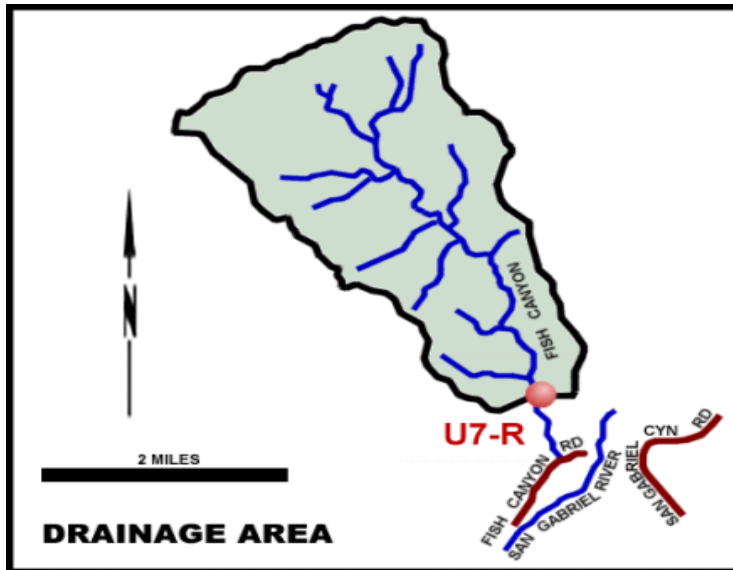

RECORDER - 5 min. interval data logger.

METHOD OF MEASUREMENT - Wading

DRAINAGE AREA - 6.36 square miles.

LOCATION - 0.8 mile upstream of mouth of canyon and 3.0 miles northeast of Duarte.

REGULATION - None.

DIVERSION - None.

CHANNEL - Natural, rock and gravel.

CONTROL - Concrete control.

LENGTH OF RECORD - July to September 1916; July 1917 to date.

REMARKS - Operated and maintained by USGS until October 1, 1971.

RUNOFF – STREAM GAGING STATION INFORMATION

LITTLE ROCK CREEK

Above Little Rock Dam.

STATION NO. L1-R

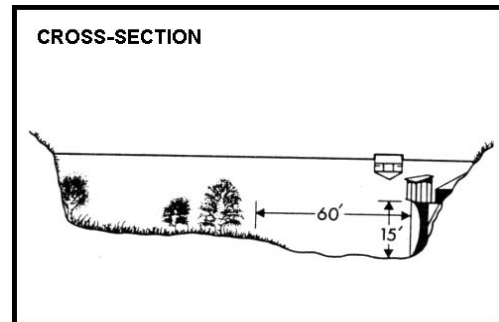
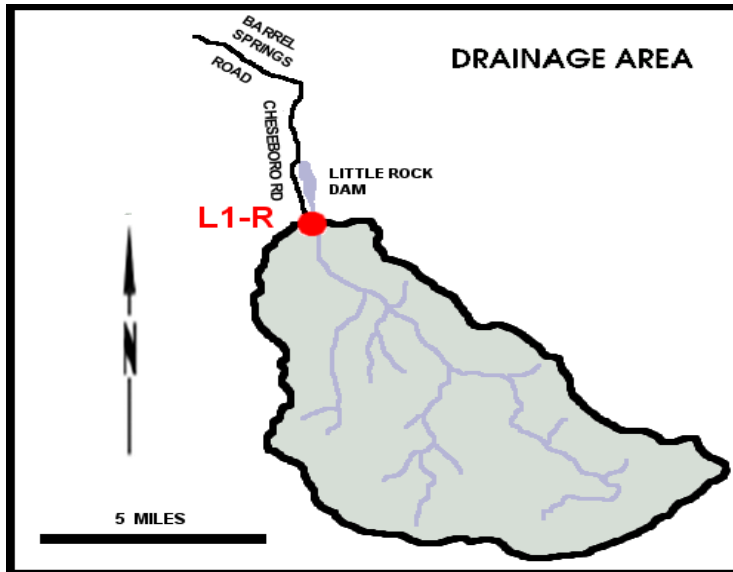

RECORDER - Continuous water stage.

METHOD OF MEASUREMENT - Stream gaging.

DRAINAGE AREA - 49.2 square miles.

LOCATION - 2.0 miles above Little Rock Dam, 5.0 miles south of Little Rock.

REGULATION - None.

DIVERSION - None.

CHANNEL - Sand, gravel, and boulder, natural in section.

CONTROL - Channel forms control.

LENGTH OF RECORD - October 1, 1930 to date.

REMARKS - None.

RUNOFF – STREAM GAGING STATION INFORMATION

LIVE OAK CREEK

Below Live Oak Dam.

STATION NO. F356-R

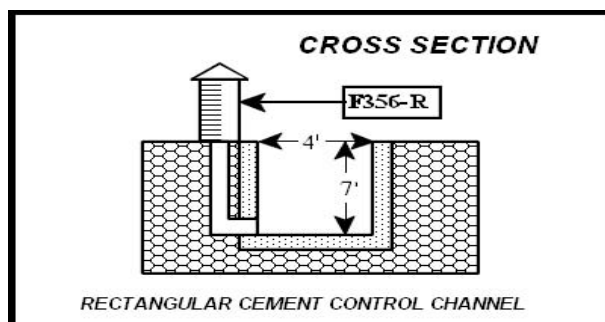
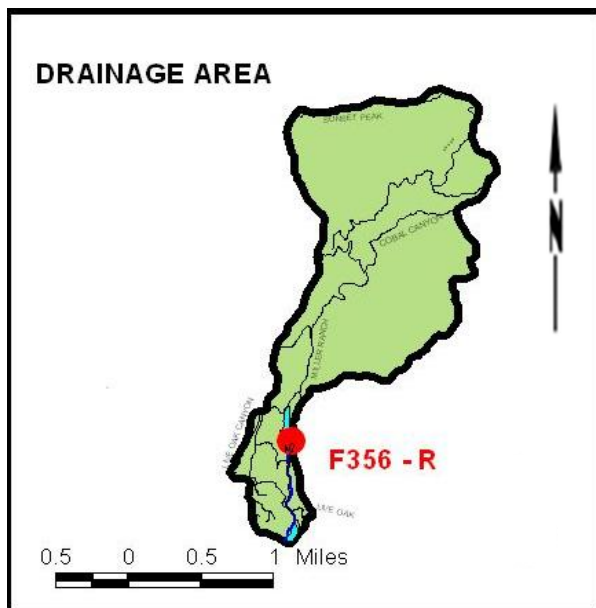

RECORDER - Continuous water stage.

METHOD OF MEASUREMENT - Wading

DRAINAGE AREA - 2.28 square miles.

LOCATION - On the right (west) bank of stream, 0.5 mile above mouth of canyon and 100 feet below Live Oak Dam, about 2.5 miles northeast of La Verne. Elevation of gage 1427.01 feet.

REGULATION - Flow regulated by Live Oak Dam, spillway enter canyon below station and are not included in these records.

DIVERSION - None.

CHANNEL - Natural channel.

CONTROL - San Dimas type flume.

LENGTH OF RECORD - At Station F356-R from November 29, 1963 to September 30, 1965, for prior records (beginning January 1928) see Station F31-R, Live Oak Creek near mouth of canyon, and from September 30, 1965 to date.

REMARKS - None.

RUNOFF – STREAM GAGING STATION INFORMATION

LOS ANGELES RIVER

Below Wardlow River Road.

STATION NO. F319-R

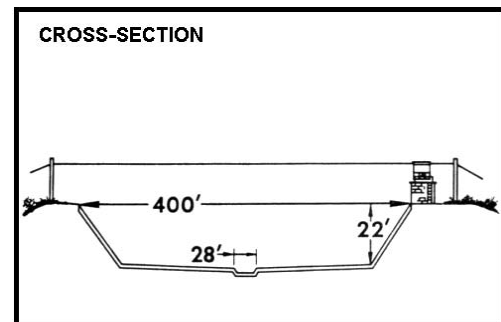
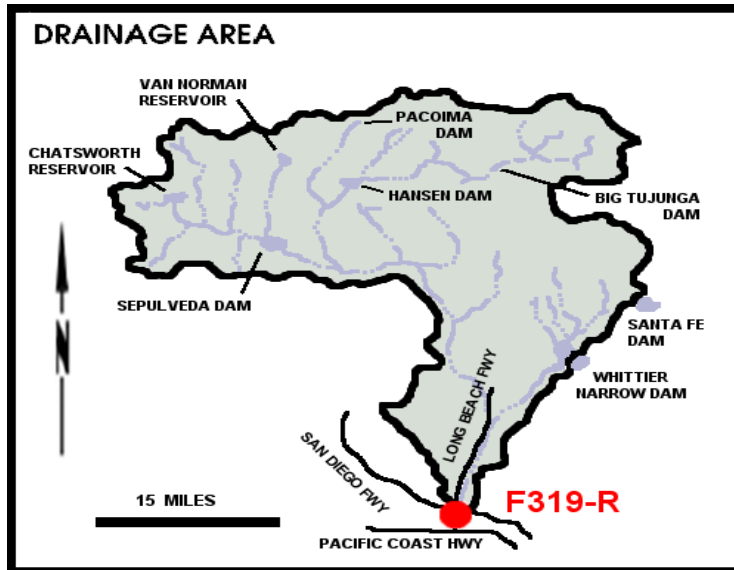

RECORDER - Continuous water stage.

METHOD OF MEASUREMENT - Wading

DRAINAGE AREA - 815.0 square miles.

LOCATION - 900.0 feet below Wardlow Road, Long Beach.

REGULATION - Flow is subject to the same regulation as Station F34D-R and P45B-R.

DIVERSION - Flows diverted to Dominguez Gap Spreading Grounds.

CHANNEL - Trapezoidal, concrete, 302.0 feet wide at bottom with 2.25:1 side slopes. Low flow channel 28.0 feet wide by 1.0 foot deep in center of channel.

CONTROL - Channel forms control.

LENGTH OF RECORD - At Station F180-R, October 31, 1931 to January 13, 1956; at Station F319-R, January 13, 1956 to date.

REMARKS - Prior to 1931, see Station F36-R.

RUNOFF – STREAM GAGING STATION INFORMATION

LOS ANGELES RIVER

Below Firestone Blvd.

STATION NO. F34D-R

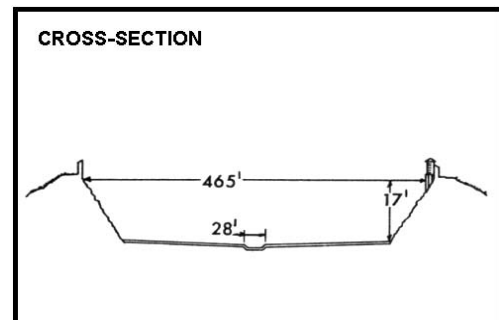
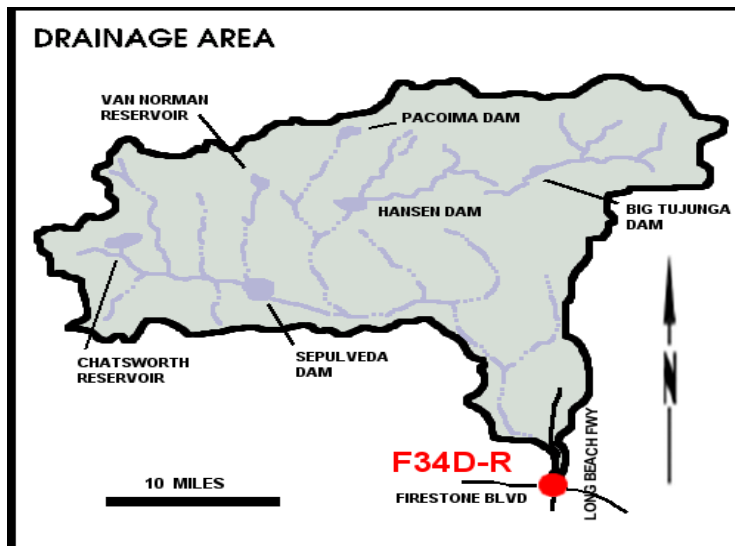

RECORDER - Continuous water stage.

METHOD OF MEASUREMENT - Wading or from bridge.

DRAINAGE AREA - 596.0 square miles.

LOCATION - 472.0 feet downstream of Firestone Boulevard, 3.0 miles west of Downey.

REGULATION - Partially regulated by Sepulveda, Pacoima, Big Tujunga, Hansen, and Devils Gate Dam; and by several spreading grounds, reservoirs, and debris basins.

DIVERSION - None.

CHANNEL - Concrete, with rip-rap side slopes, trapezoidal in section, with trapezoidal low flow channel.

CONTROL - Channel forms control.

LENGTH OF RECORD - At Station F34-R, March 1, 1928 to April 11, 1938; at Station F34B-r, April 11, 1938 to November 3, 1949; at Station F34C-R, November 4, 1949 to December 11, 1956; at Station F34D-R, December 11, 1956 to December 2013.

REMARKS - Subject to diversion from Big Tujunga Creek, Arroyo Seco, and other domestic irrigation diversions.

RUNOFF – STREAM GAGING STATION INFORMATION

LOS ANGELES RIVER

At Tujunga Avenue.

STATION NO. F300-R

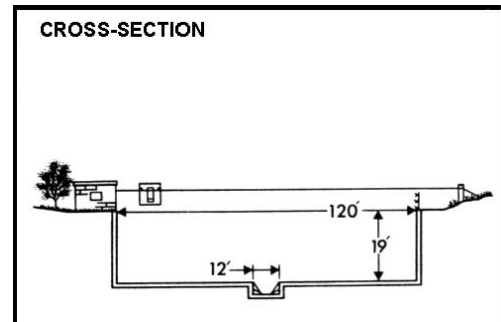
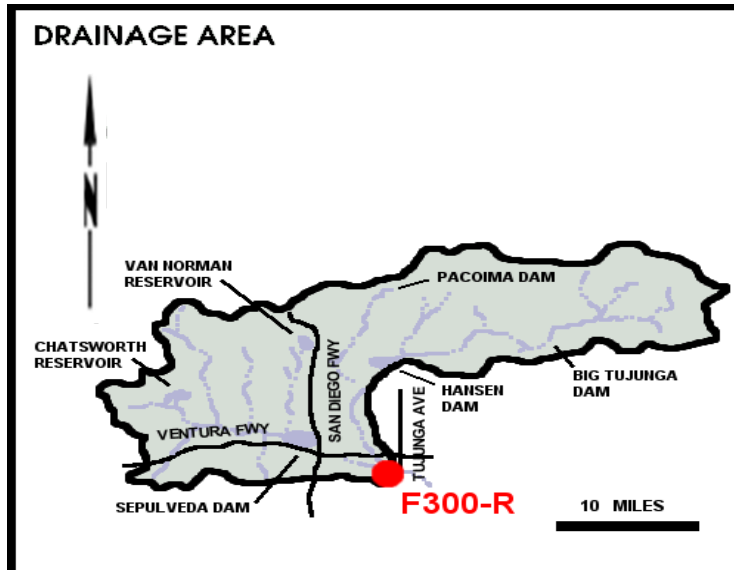

RECORDER - Continuous water stage.

METHOD OF MEASUREMENT - Wading

DRAINAGE AREA - 401.0 square miles.

LOCATION - 200.0 feet above Tujunga Avenue bridge, Studio City.

REGULATION - Flow regulated by Sepulveda, Big Tujunga, Hansen, Pacoima Dams, Lopez Debris Dam, and Project No. 85 Diversion.

DIVERSION - None.

CHANNEL - Concrete, rectangular section, 120 feet wide by 19 feet deep.

CONTROL - Channel forms control.

LENGTH OF RECORD - May 8, 1950 to date.

REMARKS - Subject to diversions at mouth of Big Tujunga and Pacoima Canyons for irrigation, at Big Tujunga, Branford, Hansen, and Pacoima Spreading Grounds.

RUNOFF – STREAM GAGING STATION INFORMATION

LOS ANGELES RIVER

Above Arroyo Seco

STATION NO. F57C-R

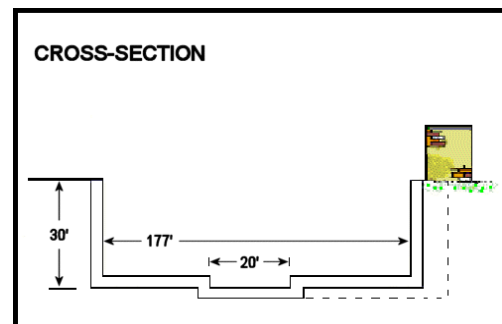
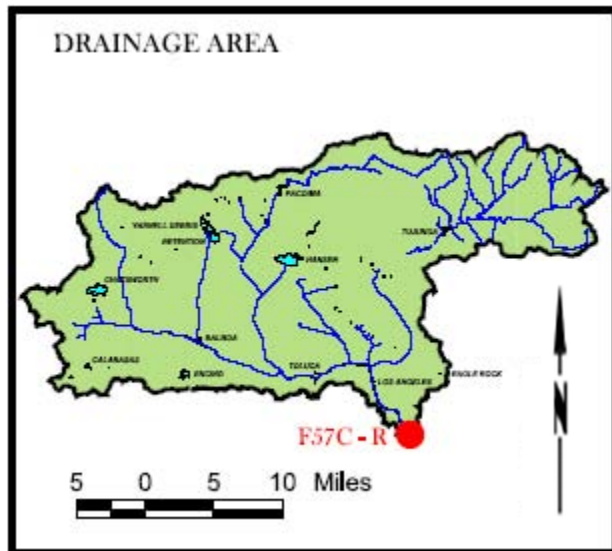

RECORDER - Continuous water stage.

METHOD OF MEASUREMENT - Wading

DRAINAGE AREA - 511.0 square miles.

LOCATION - 800 feet above the confluence of the Arroyo Seco with the Los Angeles River, Los Angeles.

REGULATION - Partially regulated by Sepulvedo, Pacoima, Big Tujunga, and Hansen Dams; and by several spreading grounds, reservoirs, and debris basins.

DIVERSION - None.

CHANNEL - Concrete, rectangular in section, with a trapezoidal low-flow channel.

CONTROL - Channel forms control.

LENGTH OF RECORD - At Station F57-R, December 5, 1929 to May 26, 1938; at Station F57B-R, April 5, 1939 to December 8, 1939; at Station F57C-R, December 8, 1939 to date.

REMARKS - Subject to diversions from Big Tujunga Creek, and other diversions for domestic and irrigation uses.

RUNOFF – STREAM GAGING STATION INFORMATION

MALIBU CREEK

Below Cold Creek.

STATION NO. F130-R

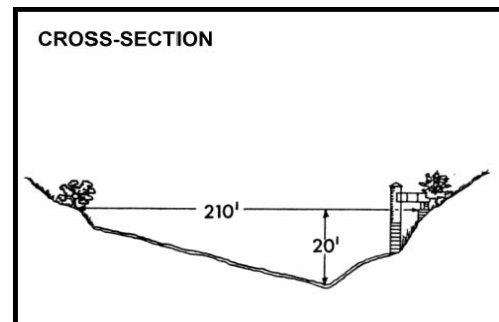
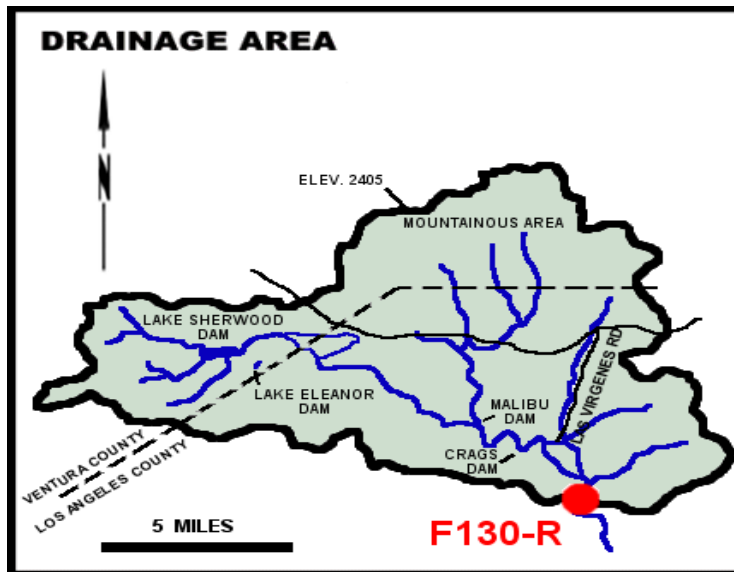

RECORDER - 5 min. interval data logger.

METHOD OF MEASUREMENT - Wading

DRAINAGE AREA - 104.96 square miles.

LOCATION - 0.2 mile downstream of Cold Creek, 6.0 miles southwest of Calabasas.

REGULATION - Lake Sherwood Dam, Lake Eleanor Dam, Malibu Lake Dam and Crags Dam. Other small recreational dams affect low summer flows.

DIVERSION - None.

CHANNEL - Coarse sand and gravel, lined with trees and brush, natural in section.

CONTROL - Concrete stabilizer.

LENGTH OF RECORD - January 17, 1931 to date.

REMARKS - Cableway washed out on January 25, 1969, no high flow measurements since that date.

RUNOFF – STREAM GAGING STATION INFORMATION

MESCAL CREEK

At mouth of canyon.

STATION NO. F395-R

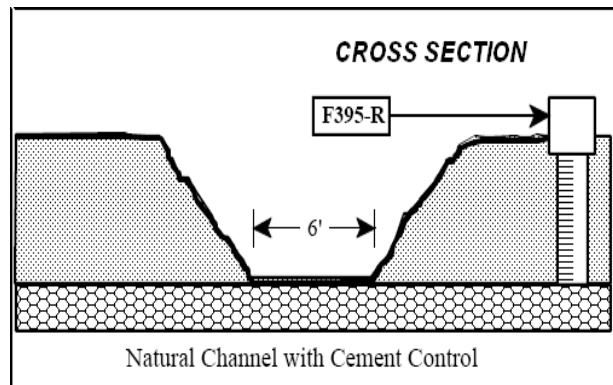
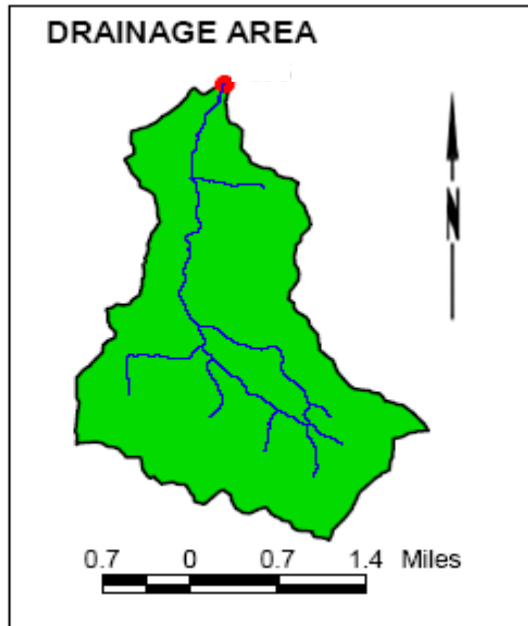

RECORDER - Continuous water stage.

METHOD OF MEASUREMENT - Wading

DRAINAGE AREA - 5.41 square miles.

LOCATION - On left bank, 75 feet east of Mescal Canyon Motorway, 2.7 miles south of Fort Tejon Road, and 3.8 miles southwest of Pinon Hills.

REGULATION - Slight regulation of low flow by Jackson Lake

DIVERSION - One small diversion upstream from station for domestic use.

CHANNEL - Natural channel.

CONTROL - Concrete stabilizer.

LENGTH OF RECORD - October 2001 to date.

REMARKS - None.

RUNOFF – STREAM GAGING STATION INFORMATION

MINT CANYON CREEK

At Sierra Highway.

STATION NO. F328B-R

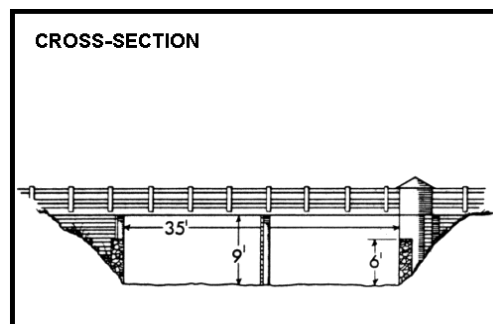
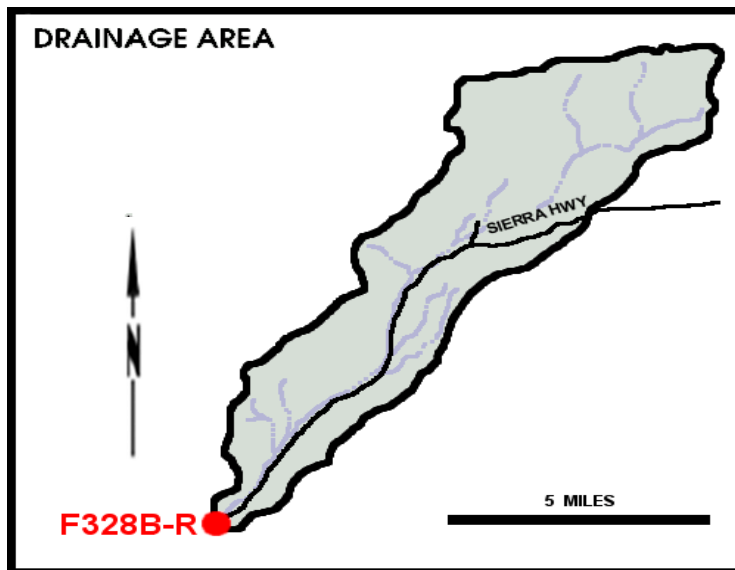

RECORDER - Continuous water stage.

METHOD OF MEASUREMENT - Wading or from cable car.

DRAINAGE AREA - 28.00 square miles.

LOCATION - On left bank, on upstream side of Sierra Highway bridge, 1.6 miles upstream from confluence with Santa Clara River, and 3.3 miles east of Saugus.

REGULATION - None.

DIVERSION - None.

CHANNEL - Natural, sand and gravel.

CONTROL - Concrete control at downstream end of bridge.

LENGTH OF RECORD - At station F328-R, October 26, 1956 to October 1, 2001, at station F328B-R, November 4, 2001 to date.

REMARKS - Station F328B-R.

RUNOFF – STREAM GAGING STATION INFORMATION

MONTEBELLO STORM DRAIN

Above Rio Hondo.

STATION NO. F181-R

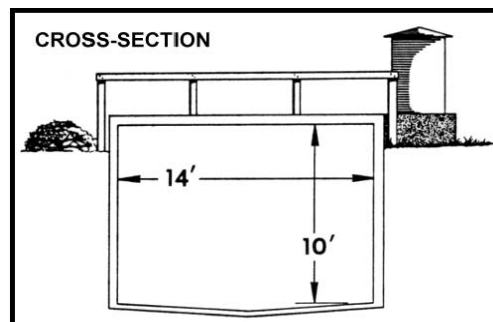
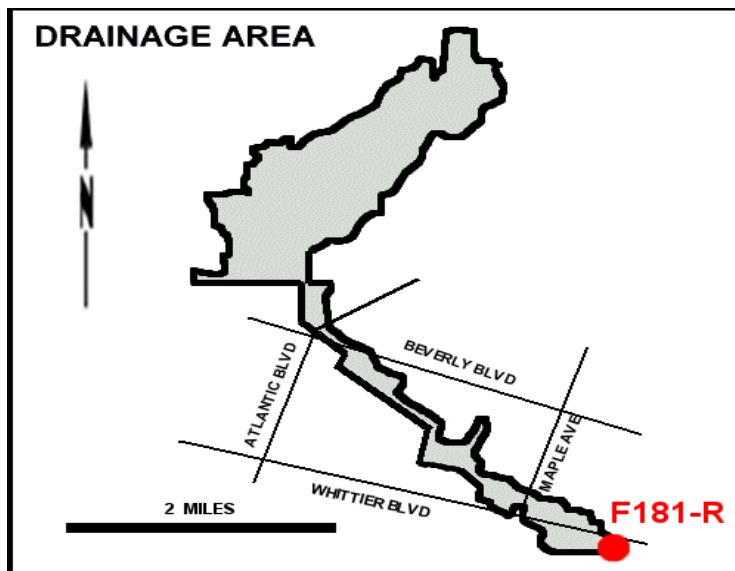

RECORDER - Continuous water stage.

METHOD OF MEASUREMENT - Wading or from footbridge.

DRAINAGE AREA - 9.6 square miles.

LOCATION - 150.0 feet east of Mines Avenue and 500.0 feet west of Rio Hondo.

REGULATION - None.

DIVERSION - None.

CHANNEL - 14.0 foot by 10.0 foot concrete, box section.

CONTROL - Channel forms control.

LENGTH OF RECORD - January 12, 1932 to date.

REMARKS - May be affected by backwater during flood flows.

RUNOFF – STREAM GAGING STATION INFORMATION

PACOIMA CREEK

Below Pacoima Dam.

STATION NO. F118C-R

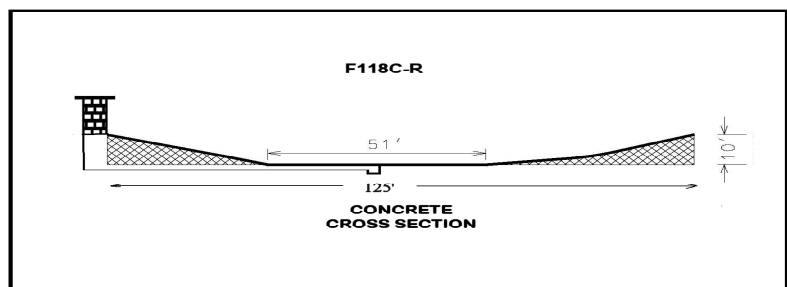
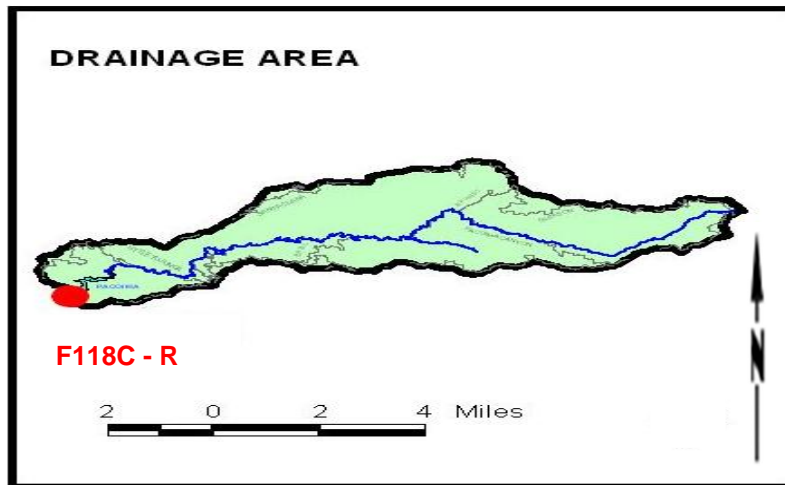

RECORDER - Continuous water stage.

METHOD OF MEASUREMENT - Wading or from bridge.

DRAINAGE AREA - 28.2 square miles.

LOCATION - East of San Fernando, and about 500 feet downstream from Pacoima Dam, former station F118-R was approximately 450 feet downstream, former station U13-R was approximately 0.5 mile downstream. Elevation of gage, about 1650 feet.

REGULATION - Regulated by Pacoima Dam, station F118-R and F118B-R do not include spillway discharges, station U13-R was so located that it would have included spillway discharge.

DIVERSION - Water passing over Pacoima Dam spillway enters Pacoima Creek below station F118-R.

CHANNEL - Gravel and boulders.

CONTROL - Channel forms control.

LENGTH OF RECORD - At Station U13-R, Pacoima Creek near San Fernando, California, at office of USGS, water resources branch, Los Angeles, from March 1916 to September 1929, from October 1, 1929 to March 23, 1933, records based on Dam outflow records and gage readings at the marsh flume below Pacoima Dam, these records are available at the office of the Los Angeles County Flood Control District, at Station F118-R March 24, 1933 to February 1, 1935, at Station F118B-R February 9, 1935 to April 28, 1937 and June 25, 1937 to June 15, 1943, and from September 15, 1943 to June 30, 2012, at Station F118C-R from July 1, 2012 to date.

REMARKS - Located, constructed and operated by the Los Angeles County Flood Control District in cooperation with the USGS, Water Resources Branch.

RUNOFF – STREAM GAGING STATION INFORMATION

PACOIMA DIVERSION

At Branford Street.

STATION NO. F305-R

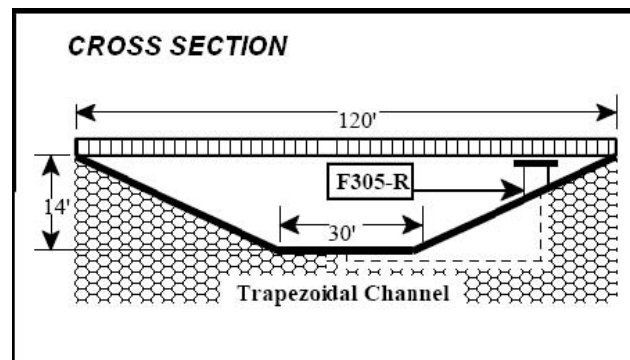
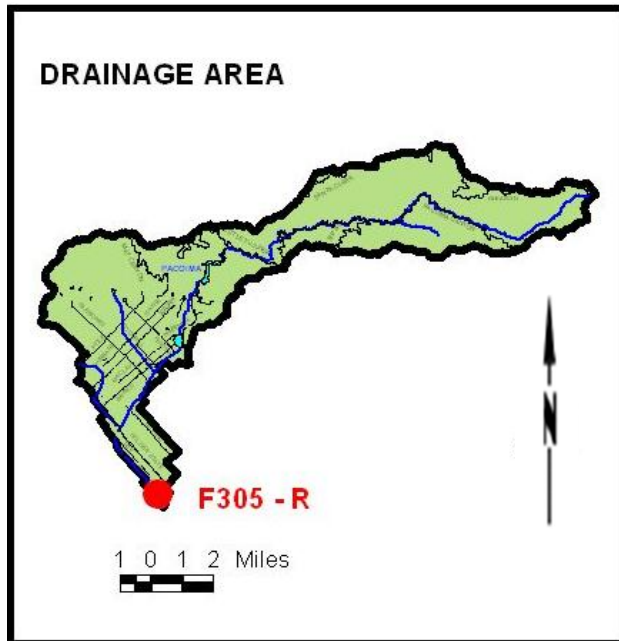

RECORDER - Continuous water stage.

METHOD OF MEASUREMENT - Wading or from footbridge.

DRAINAGE AREA - 48.8 square miles.

LOCATION - On the left (northeasterly) bank of the channel, 35 feet above Branford street bridge. Elevation of zero gage height 844 feet.

REGULATION - Flow regulated by Pacoima Dam and Pacoima Spreading Grounds.

DIVERSION - Small diversions for irrigation near mouth of canyon, water diverted to Lopez Basin and Pacoima Spreading Grounds during spreading operations.

CHANNEL - Trapezoidal concrete, with grouted rock walls.

CONTROL - Channel forms control.

LENGTH OF RECORD - October 30, 1953 to September 30, 1967, from October 1, 1988 to date.

REMARKS - Located and constructed by the Corps of Engineers, Department of Army, operated by the Los Angeles County Flood Control District.

RUNOFF – STREAM GAGING STATION INFORMATION

PALLETT CREEK

At Valyermo Highway.

STATION NO. F122-R

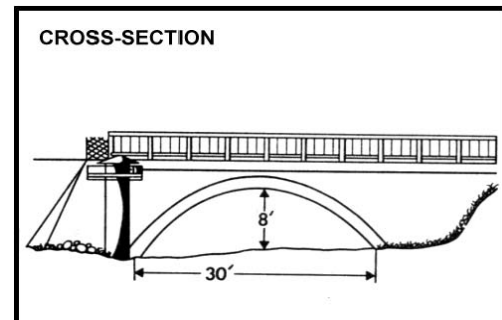
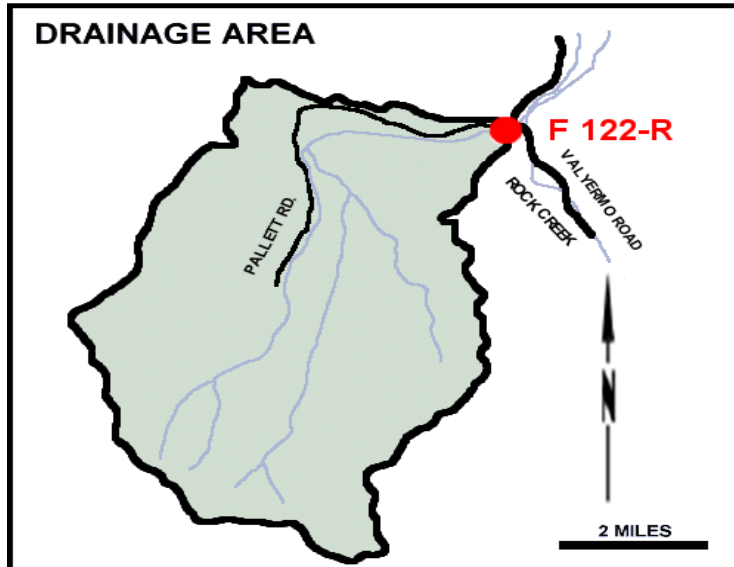

RECORDER - Continuous water stage.

METHOD OF MEASUREMENT - Wading or from bridge.

DRAINAGE AREA - 15.8 square miles.

LOCATION - Upstream side of Valyermo Highway bridge, 5.0 miles southeast of Pearblossom.

REGULATION - None.

DIVERSION - None.

CHANNEL - Sand and gravel, natural section.

CONTROL - Channel forms control for low flows; bridge form control for high flows.

LENGTH OF RECORD - At Station F122-S, December 29, 1930 to October 31, 1961; at Station F122-R, October 31, 1961 to date.

REMARKS - None.

RUNOFF – STREAM GAGING STATION INFORMATION

RIO HONDO

Above Stuart and Gray Road.
STATION NO. F45B-R

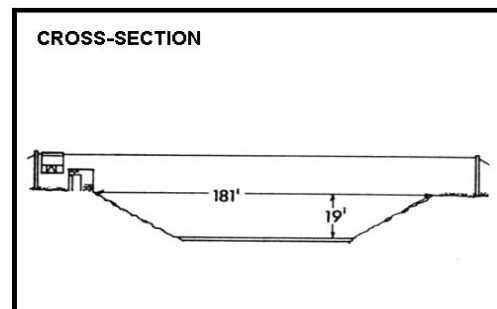
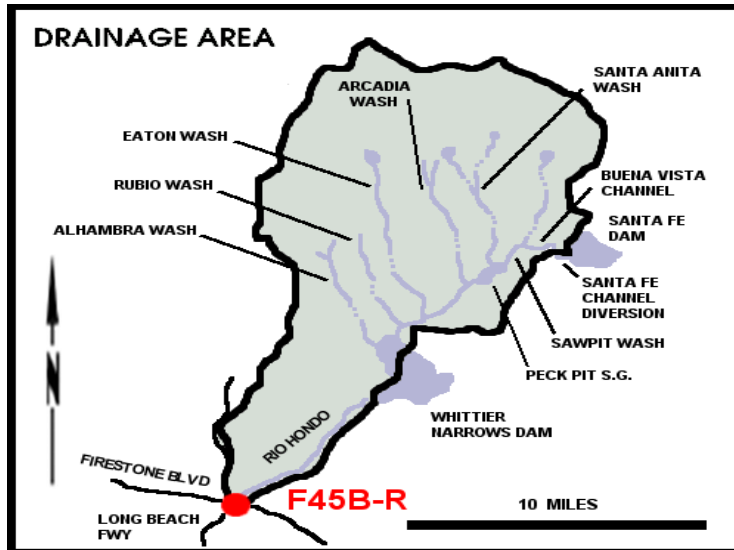

RECORDER - Continuous water stage.

METHOD OF MEASUREMENT - Wading or from cable car.

DRAINAGE AREA - 140.0 square miles.

LOCATION - 0.6 mile upstream of the confluence of Rio Hondo and Los Angeles River, 1.5 miles west of Downey.

REGULATION - Partially regulated by Sierra Madre, Santa Anita, Sawpit, Eaton, Santa Fe, and Whittier Narrows Dams, several debris basins, and spreading grounds.

DIVERSION - None.

CHANNEL - Concrete with rip-rap side slopes, trapezoidal in section.

CONTROL - Channel forms control.

LENGTH OF RECORD - At Station F45-R, March 1, 1928 to April 18, 1951; at Station F45B-R, October 31, 1951 to date.

REMARKS - Subject to diversions from Eaton Creek, Monrovia Creek, Sawpit Creek, Little Santa Anita Canyon, and other locations for irrigation and spreading. High flows from San Gabriel River may flow into Rio Hondo above Whittier Narrows Dam.

RUNOFF – STREAM GAGING STATION INFORMATION

RIO HONDO

Below Lower Azusa Avenue.
STATION NO. F192B-R

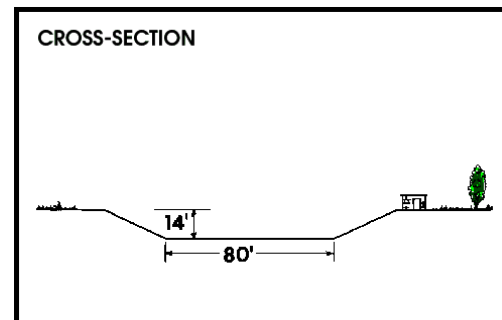
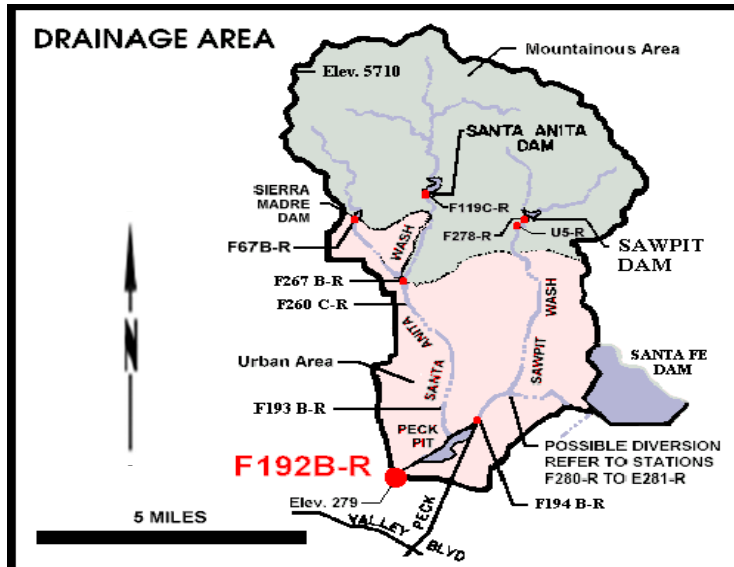

RECORDER - 5 min. interval data logger.

METHOD OF MEASUREMENT - Wading

DRAINAGE AREA - 40.9 square miles.

LOCATION - 300 feet downstream from Lower Azusa Road, 1.5 miles north of El Monte.

REGULATION - Partially regulated by Sierra Madre Dam, Santa Anita Dam, Sawpit Dam, Santa Fe Dam, Peck Pit, Buena Vista Pit, and several debris basins.

DIVERSION - None.

CHANNEL - Concrete, trapezoidal section, 80.0 feet wide by 14.0 feet deep.

CONTROL - Channel forms control.

LENGTH OF RECORD - At Station F192-R, February 22, 1932 to May 7, 1958; at Station F192B-R, May 7, 1958 to date.

REMARKS - Subject to diversions from Monrovia, Sawpit, and Little Santa Anita Creeks. Also from the San Gabriel River below Santa Fe Dam; and from irrigation and spreading.

RUNOFF – STREAM GAGING STATION INFORMATION

RIO HONDO BYPASS

Zone One Ditch

STATION NO. F313B-R

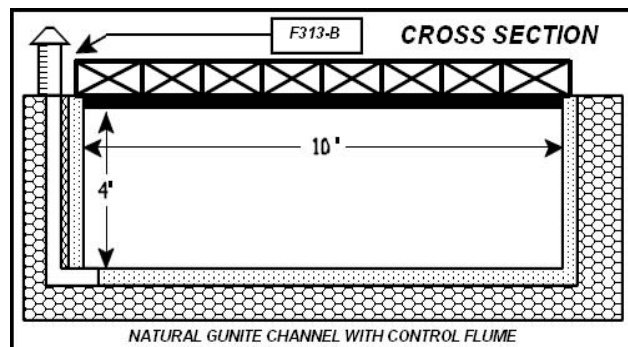
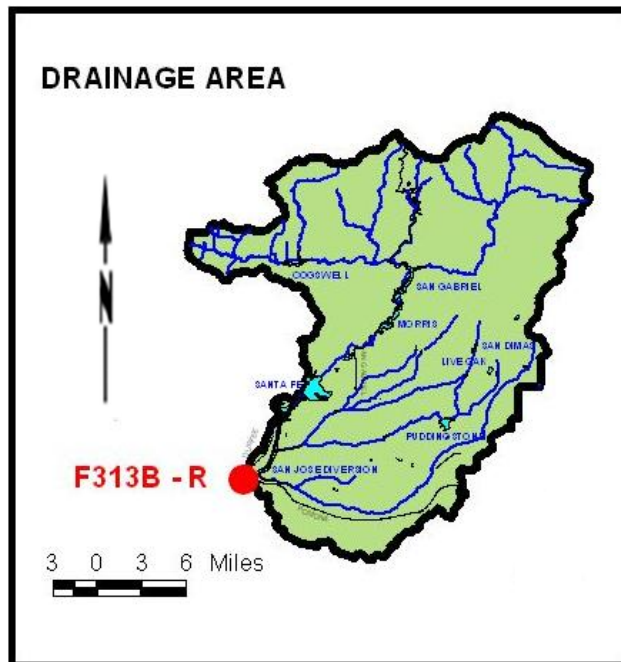

RECORDER - 5 min. interval data logger.

METHOD OF MEASUREMENT - Wading or from footbridge.

DRAINAGE AREA – 445.7 square miles.

LOCATION - On the left (south) bank of the channel 400 feet below diversion headworks.

REGULATION - Flow regulated at headworks installed to divert a portion of Zone I water from the San Gabriel River to Rio Hondo.

DIVERSION - None.

CHANNEL - Soil, sand, and clay.

CONTROL - Artificial controls below station.

LENGTH OF RECORD - October 1, 1953 to October 1, 1963, and from October 1, 1974 to September 30, 1982, and from October 1, 1982 to date.

REMARKS - Used only for Zone I purchased water diverted to Rio Hondo Spreading Grounds.

RUNOFF – STREAM GAGING STATION INFORMATION

RUBIO DIVERSION CHANNEL

Below Gooseberry Inlet.
STATION NO. F338-R

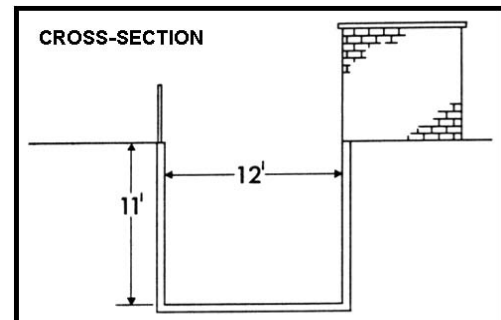
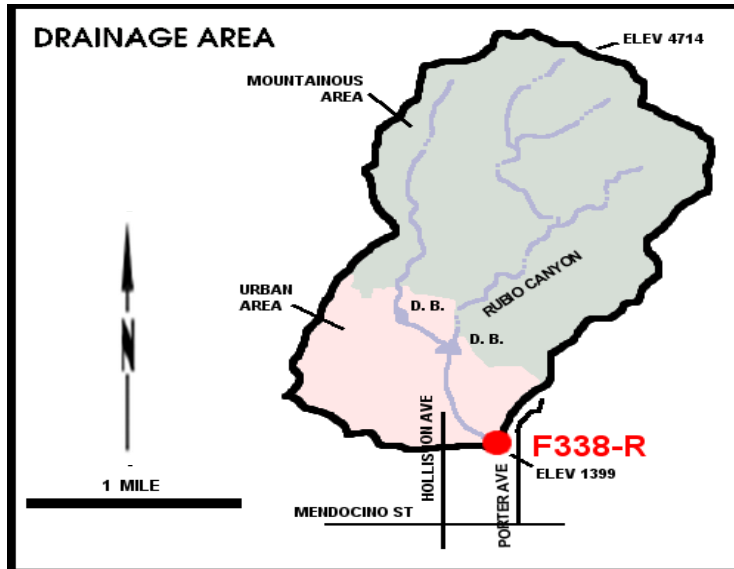

RECORDER - 5 min. interval data logger.

METHOD OF MEASUREMENT - Low flows measured by wading. High flows measured from steel footbridge 27 feet above station.

DRAINAGE AREA - 2.1 square miles.

LOCATION - On the north bank, 375 feet upstream of Crest Drive, 3.5 miles northeast of Pasadena.

REGULATION - Flow partially regulated by Rubio and Goosebury Debris Basins.

DIVERSION - None.

CHANNEL - Retangular concrete, 12 feet wide and 11 feet deep.

CONTROL - Channel forms control.

LENGTH OF RECORD - December 16, 1959 to date.

REMARKS - None.

RUNOFF – STREAM GAGING STATION INFORMATION

RUBIO WASH

At Glendon Way.

STATION NO. F82C-R

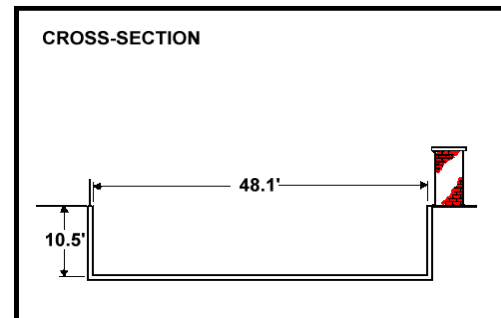
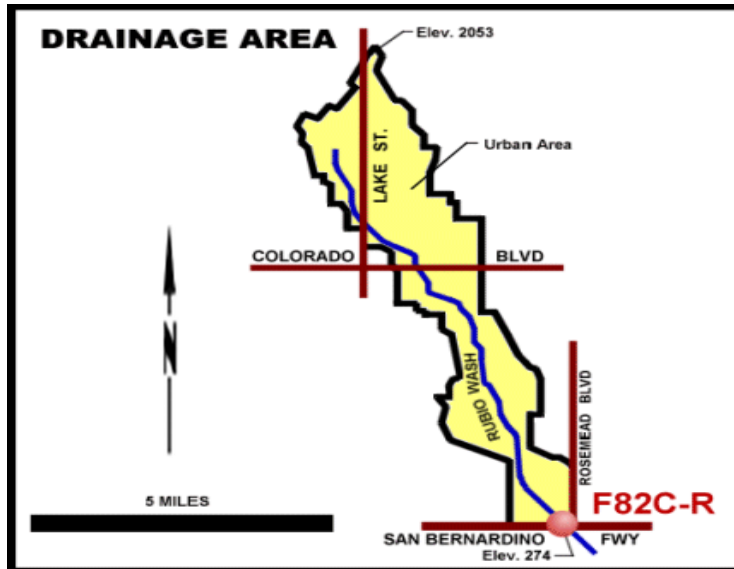

RECORDER - 5 min. interval data logger.

METHOD OF MEASUREMENT - Low flows measured by wading. High flows measured from footbridge at station.

DRAINAGE AREA - 10.9 square miles.

LOCATION - On the east side of channel, 10 feet south of the westerly extension of Glendon Way, Rosemead.

REGULATION - Partly regulated by Las Flores and Rubio debris basins.

DIVERSION - None.

CHANNEL - Concrete, rectangular in section.

CONTROL - Channel forms control.

LENGTH OF RECORD - At station F82-R, October 1931 to October 1934; at station F82B-R, October 1934 to October 1937; at station F82C-R, November 6, 1936 to date.

REMARKS - None.

RUNOFF – STREAM GAGING STATION INFORMATION

SAN DIMAS CREEK

Below San Dimas Dam.

STATION NO. F303-R

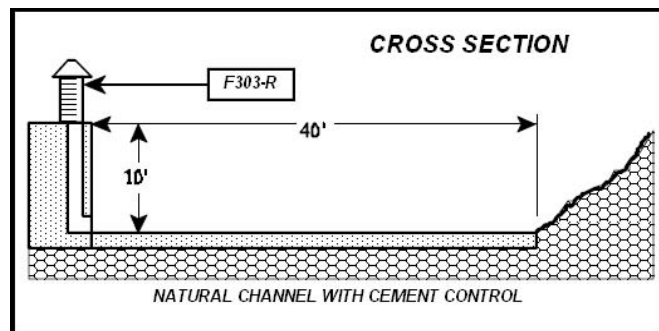
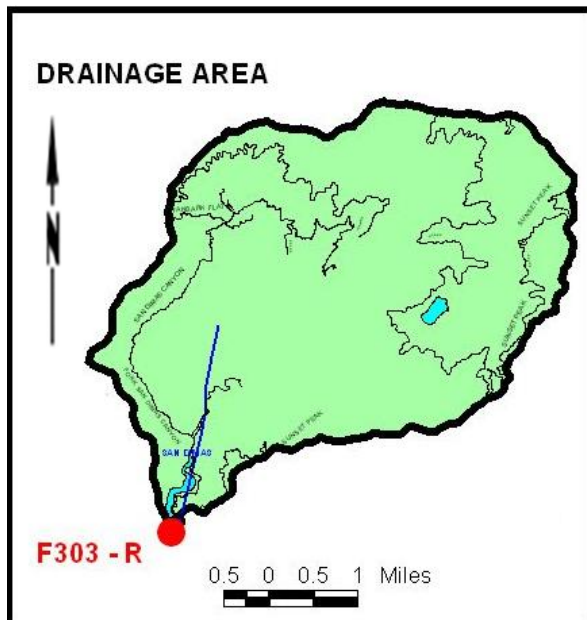

RECORDER - Continuous water stage.

METHOD OF MEASUREMENT - Wading or from cable car.

DRAINAGE AREA - 16.2 square miles.

LOCATION - On the left (east) bank of San Dimas Creek, 350 feet below San Dimas Dam. Elevation of zero gage height 1325 feet.

REGULATION - Flow regulated by San Dimas Dam and partially by old water tunnel 150 feet above station.

DIVERSION - None.

CHANNEL - Natural channel.

CONTROL - A concrete control installed below station to keep low flow at left bank.

LENGTH OF RECORD - December 24, 1951 to date.

REMARKS - Located, constructed and operated by the Los Angeles County Flood Control District.

RUNOFF – STREAM GAGING STATION INFORMATION

SAN DIMAS WASH

Below Puddingstone Diversion.

STATION NO. F218-R

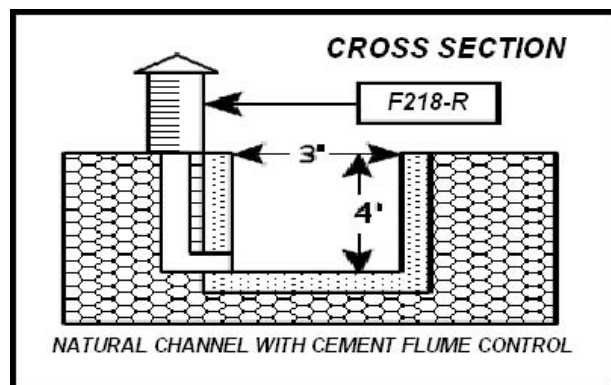
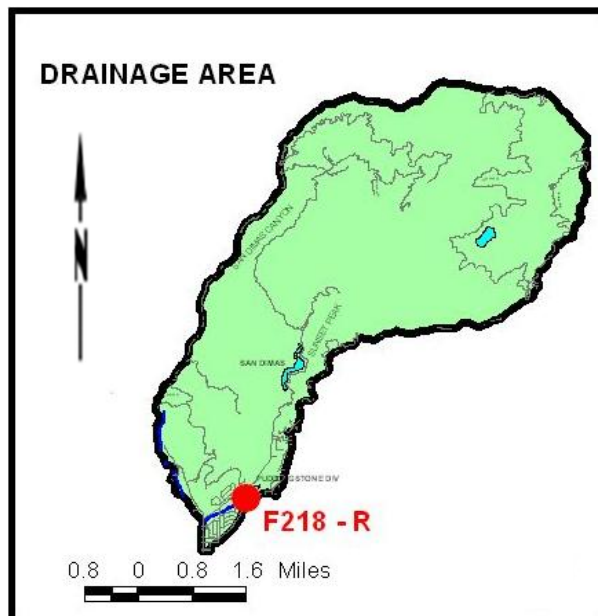

RECORDER - Continuous water stage.

METHOD OF MEASUREMENT - Wading

DRAINAGE AREA - 19.9 square miles.

LOCATION - On San Dimas type flume about 75 feet west of the southerly end of Puddingstone Diversion Dam about 3 miles northwest of La Verne. Elevation of zero gage height 1126.86 feet

REGULATION - Flow entirely regulated by Puddingstone Diversion Dam, spillway discharge enters wash below the station, inflow into Puddingstone Diversion Dam is regulated by San Dimas Dam.

DIVERSION - San Dimas Water Company diverts water below San Dimas Dam for irrigation.

CHANNEL - Sand and gravel.

CONTROL - 3ft X 3ft San Dimas Type Flume control.

LENGTH OF RECORD - October 1, 1945 to date

REMARKS - None..

RUNOFF – STREAM GAGING STATION INFORMATION

SAN GABRIEL - AZUSA CONDUIT

(Sandbox 20ft weir)

STATION NO. F250-R

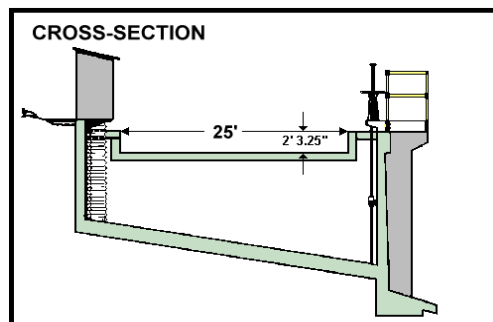
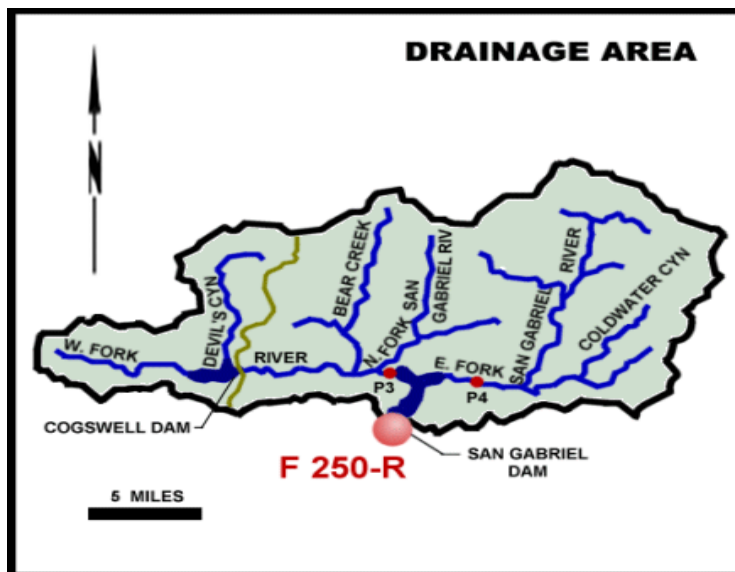

RECORDER - 5 min. interval data logger.

METHOD OF MEASUREMENT - Weir formula with gage height observation.

DRAINAGE AREA - 202.7 square miles.

LOCATION - On the concrete conduit which diverts from San Gabriel Dam, 160 feet below the dam.

REGULATION - Regulated in section.

DIVERSION - None.

CHANNEL - 25 foot concrete weir.

CONTROL - Channel forms control.

LENGTH OF RECORD - February 26, 1933 to date.

REMARKS - Approximate capacity 95 second-feet.

RUNOFF – STREAM GAGING STATION INFORMATION

SAN GABRIEL - AZUSA CONDUIT

(Sandbox 10ft weir)

STATION NO. F220B-R

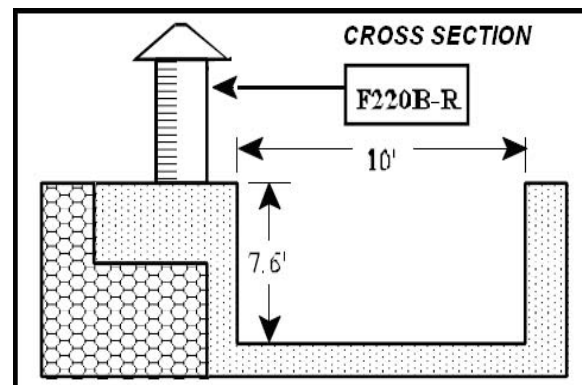
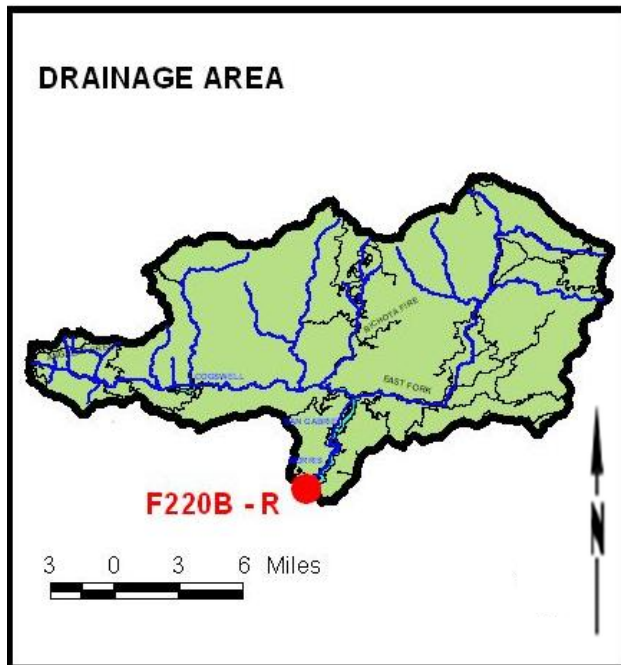

RECORDER - Continuous water stage.

METHOD OF MEASUREMENT – Weir formula with gage height observation.

DRAINAGE AREA - None

LOCATION - On the concrete conduit which diverts from San Gabriel Dam, 160 feet below the dam.

REGULATION - Flow regulated by San Gabriel Dam.

CHANNEL – Concrete, rectangular in section, 10.0 feet wide by 7.6 feet deep

CONTROL – 10 feet concrete weir.

LENGTH OF RECORD – February 26, 1933 to date.

REMARKS - Approximate capacity 95 second/feet.

RUNOFF – STREAM GAGING STATION INFORMATION

SAN GABRIEL RIVER

Above Firestone Avenue.

STATION NO. F262C-R

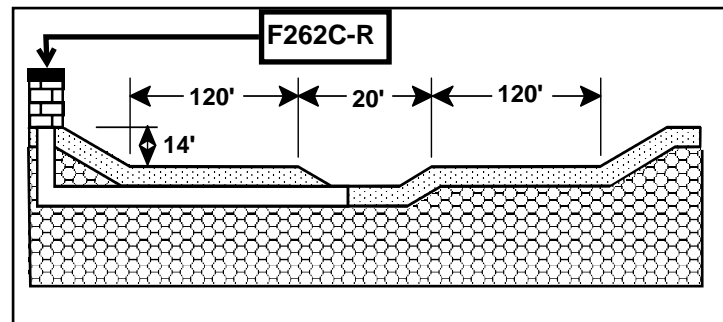
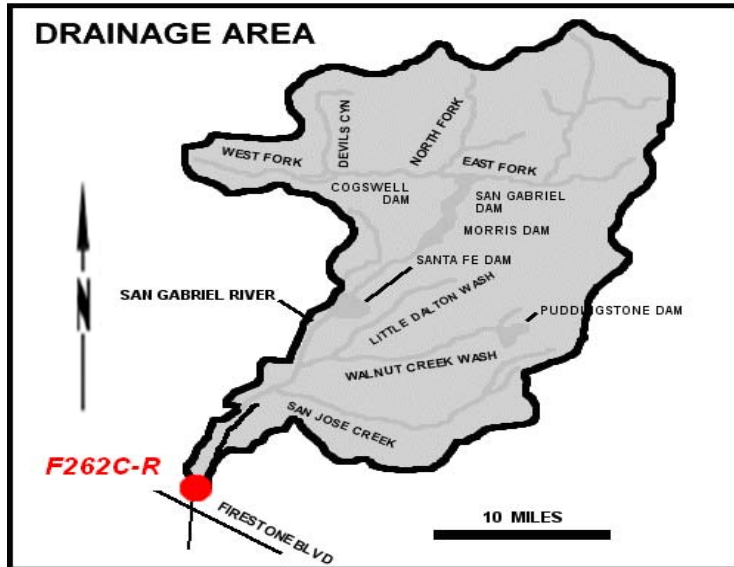

RECORDER - Continuous water stage.

METHOD OF MEASUREMENT - Float and tape recorder.

DRAINAGE AREA - 215.8 square miles.

LOCATION - 1,400 feet above Firestone Avenue, 2.0 miles east of Downey.

REGULATION - Partially regulated by Cogswell, San Gabriel, Morris, Santa Fe, Big Dalton, San Dimas, Puddingstone Diversion, Puddingstone, Live Oak, Thompson Creek, and Whittier Narrows Dams, Several debris basin, MWD outlets, and several spreading grounds.

DIVERSION - None.

CHANNEL - Trapezoidal concrete channel with trapezoidal low flow.

CONTROL - Concrete stabilizer.

LENGTH OF RECORD - At Station F267-R, February 27, 1937 to September 30, 1967; at Station F262B-R, August 6, 1968 to September 30, 1990; at Station F262C-R, October 1, 1990 to date.

REMARKS - No recording during 1967-1968 season due to channel construction.

RUNOFF – STREAM GAGING STATION INFORMATION

SAN GABRIEL RIVER

Above Spring Street.

STATION NO. F42B-R

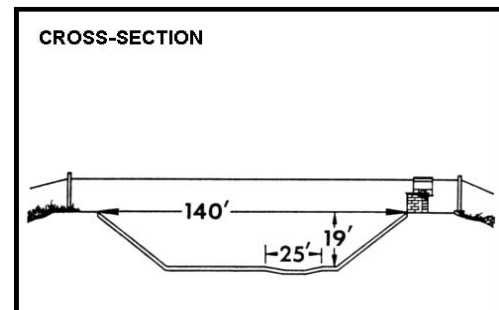
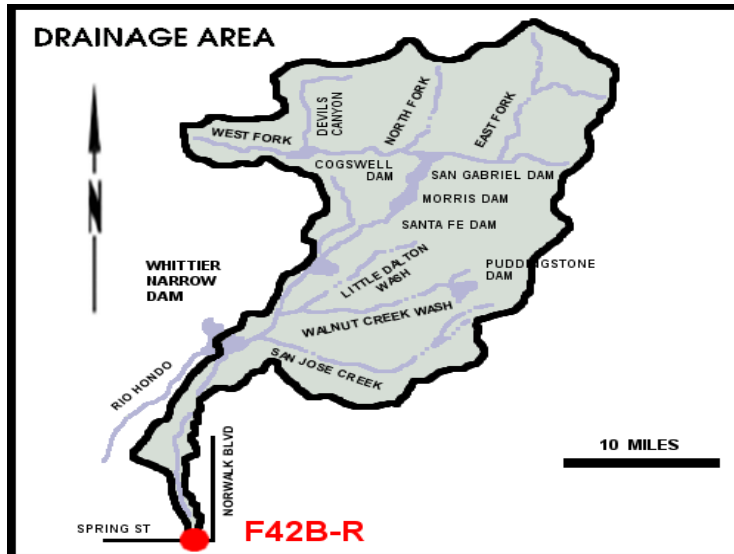

RECORDER - Continuous water stage.

METHOD OF MEASUREMENT - Wading or from cable car.

DRAINAGE AREA - 231.0 square miles.

LOCATION - 455.0 feet north of Spring Street, 4.0 miles east of Signal Hill, Long Beach.

REGULATION - Partially regulated by Cogswell, San Gabriel, Morris, Santa Fe, Big Dalton, San Dimas, Puddingstone Diversion, Puddingstone, Live Oak, Thompson Creek, and Whittier Narrows Dams, Several debris basins, MWD outlet, and several spreading grounds.

DIVERSION - None.

CHANNEL - Concrete, trapezoidal section with low flow channel.

CONTROL - Channel forms control.

LENGTH OF RECORD - At Station F42-R, February 6, 1928 to May 26, 1964; at Station F42B-R, November 16, 1964 to date.

REMARKS - High flows into Whittier Narrows Reservoir are partially diverted to the Rio Hondo.

RUNOFF – STREAM GAGING STATION INFORMATION

SAN GABRIEL RIVER

Below San Gabriel River Pkwy.

STATION NO. F263C-R

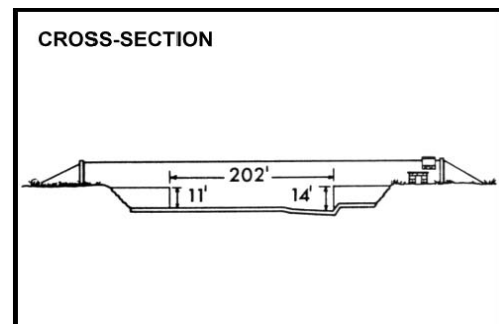
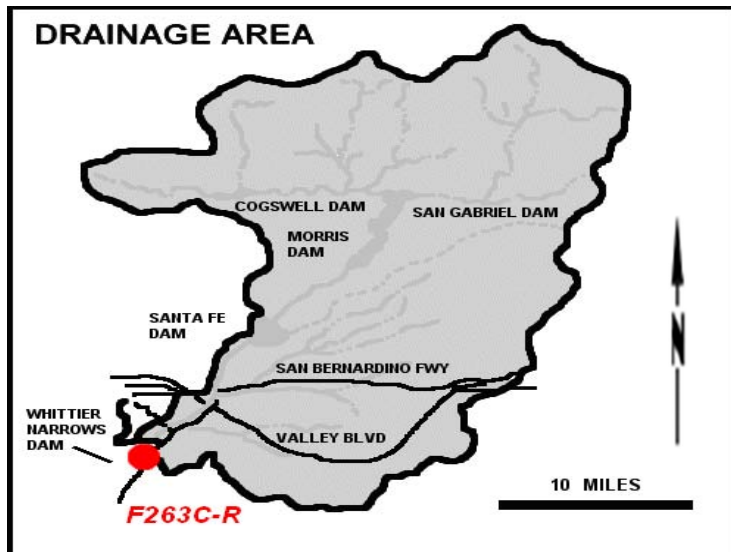

RECORDER - Continuous water stage.

METHOD OF MEASUREMENT - Wading or from cable car.

DRAINAGE AREA - 206.3 square miles.

LOCATION - 462.0 feet below San Gabriel River Parkway, 1.4 miles northeast of Pico Rivera.

REGULATION - Partially regulated by Santa Fe, Big Dalton, Puddingstone Diversion, Puddingstone, and Thompson Creek Dams. Flows may include imported water from several Metropolitan Water District outlets. Water is at times diverted to the Zone one ditch, upstream of Whittier Narrows Dam.

DIVERSION - None.

CHANNEL - Rip-rap slopes with sand bottom trapezoidal section.

CONTROL - Concrete stabilizer.

LENGTH OF RECORD - At Station F263-R, February 4, 1937 to March 6, 1952; at Station F263B-R, March 6, 1952 to August 9, 1968; at Station F263C-R, August 9, 1968 to date.

REMARKS - None.

RUNOFF – STREAM GAGING STATION INFORMATION

SAN GABRIEL RIVER

At Foothill Blvd.

STATION NO. F190-R

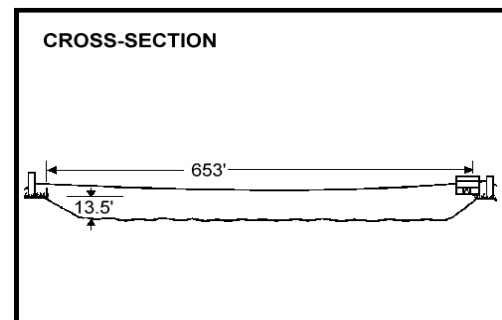
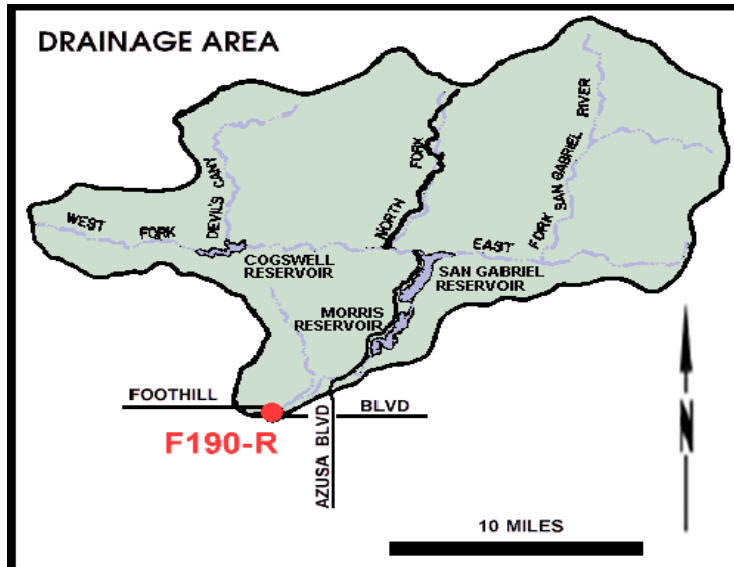

RECORDER - 5 min. interval data logger.

METHOD OF MEASUREMENT - Wading or from cable car.

DRAINAGE AREA - 230.0 square miles.

LOCATION - Downstream side of Foothill Boulevard bridge, 2.0 miles west of Azusa.

REGULATION - Partially regulated by Cogswell, San Gabriel, and Morris Dams.

DIVERSION - None.

CHANNEL - Sand, gravel and rock, trapezoidal section with soft bottom.

CONTROL - Gunited rock stabilizers.

LENGTH OF RECORD - February 22, 1932 to date.

REMARKS - Flows may include imported originating at the Metropolitan Water District outlet below Morris Dam.

RUNOFF – STREAM GAGING STATION INFORMATION

SAN GABRIEL RIVER

Below Santa Fe Dam.

STATION NO. E281-R

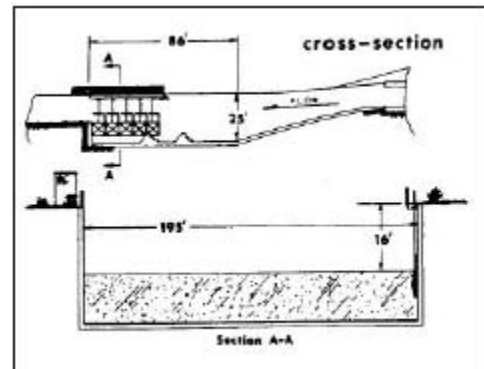
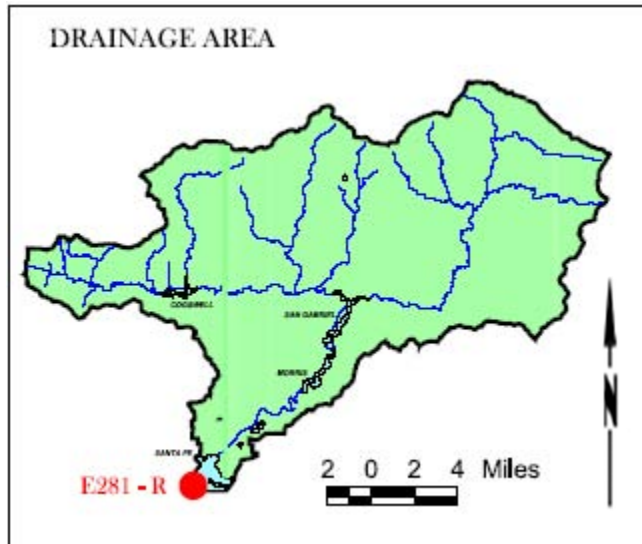

RECORDER - Continuous water stage.

METHOD OF MEASUREMENT - Wading or from cable car.

DRAINAGE AREA 236.0 Square miles (Revised)

LOCATION – 1.7 north of Baldwin Park. Elevation of gage about 400 feet.

REGULATION - Flow regulated by Santa Fe Dam.

DIVERSION - There are diversions for irrigation, power development and spreading, discharges over the spillway of Dam flow to the Rio Hondo and are not recorded at this station, five gated openings on the west side of the stilling basin may divert flow to a diversion canal to the Rio Hondo. Such diversions are measured at station F280-R, Santa Fe Channel.

CHANNEL - A stilling basin located in the outlet channel immediately below Santa Fe Dam.

CONTROL - 194.84 foot concrete overflow section to the San Gabriel River and 5 gated openings to the Rio Hondo Diversion Channel.

LENGTH OF RECORD – February 9, 1943 to date.

REMARKS – Station operated by USGS. Outflow from Santa Fe Dam may be diverted through Santa Fe Diversion Channel. Refer to Station F280-R.

RUNOFF – STREAM GAGING STATION INFORMATION

SAN GABRIEL RIVER

Below Cogswell Dam.

STATION NO. F209-R

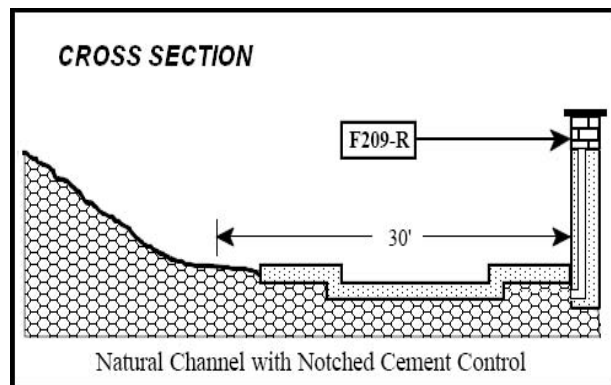
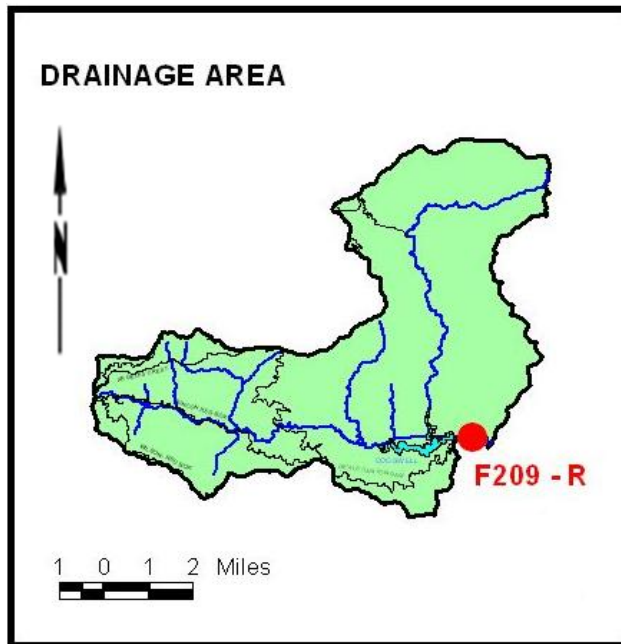

RECORDER - Continuous water stage.

METHOD OF MEASUREMENT - Wading or from cable car.

DRAINAGE AREA - 41.0 square miles.

LOCATION - On the left (northeast) bank of the west fork of the San Gabriel River about 7 miles above junction of the east and west forks and 0.5 mile downstream from Cogswell Dam. Elevation of zero gage height 2083.37 feet.

REGULATION - 40.4 square miles regulated by Cogswell Dam, 0.6 square mile unregulated.

DIVERSION - None.

CHANNEL - Sand, Gravel, and boulders.

CONTROL - Concrete control with low flow notch about 35 feet below the station.

LENGTH OF RECORD - October 1, 1933 to October 1, 1967, and from October 1, 1988 to date.

REMARKS - None.

RUNOFF – STREAM GAGING STATION INFORMATION

SAN GABRIEL RIVER

Above Whittier Narrow Dam.

STATION NO. G44B-R

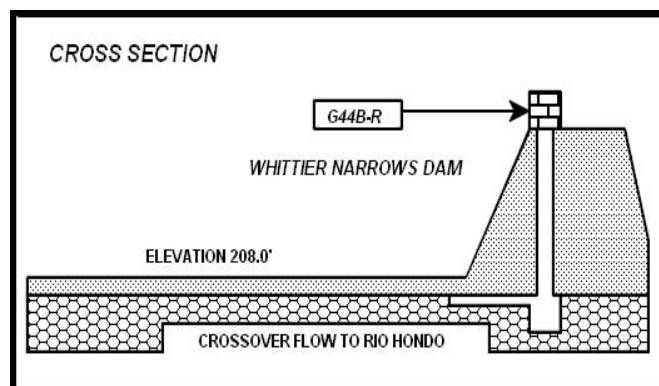
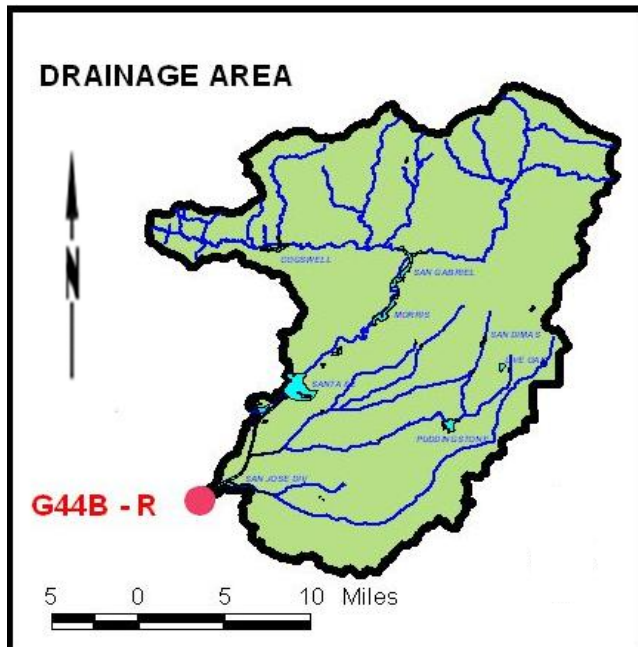

RECORDER - Continuous water stage.

METHOD OF MEASUREMENT - Stream gaging.

DRAINAGE AREA - 442 square miles.

LOCATION - On top of Whittier Narrows Dam, San Gabriel side, adjacent to radial gates.

REGULATION - Flows regulated by several reservoirs including Cogswell, San Gabriel, Morris, and Santa Fe Dams.

DIVERSION - Surface flows controlled by Whittier Narrows Dams radial gates; San Gabriel side to Rio Hondo side.

CHANNEL - Natural, rock and gravel.

CONTROL - Concrete and radial gates.

LENGTH OF RECORD - October 1, 1991 to date.

REMARKS - None.

RUNOFF – STREAM GAGING STATION INFORMATION

SAN GABRIEL RIVER

Below Morris Dam.

STATION NO. U8-R

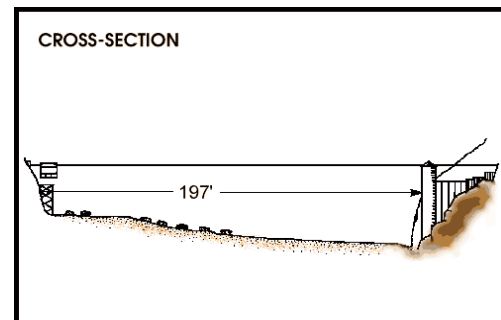
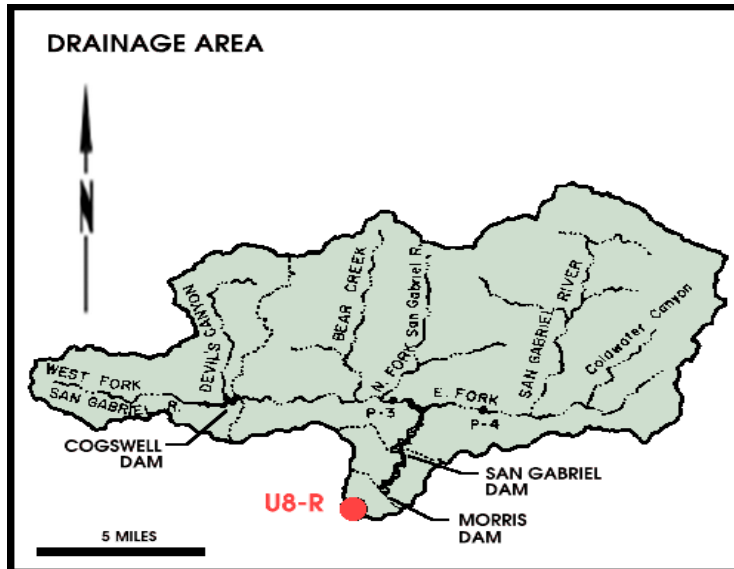

RECORDER - 5 min. interval data logger.

METHOD OF MEASUREMENT - Wading or from cable car.

DRAINAGE AREA - 212.4 square miles.

LOCATION - 1.1 miles downstream of Morris Dam, 27 miles northeast of Azusa.

REGULATION - All flows regulated by Cogswell Dam, 27 miles northeast of Azusa.

DIVERSION - None.

CHANNEL - Gravel and boulder, natural section.

CONTROL - Concrete control.

LENGTH OF RECORD - May 1894 to date.

REMARKS - Flows up to 90 cfs are at times diverted past the station through the Azusa Conduit, flows at station may include imported water from the MWD outlet below Morris Dam.

RUNOFF – STREAM GAGING STATION INFORMATION

San Gabriel River West Fork

At toe of Cogswell Dam.

STATION NO. F251-R

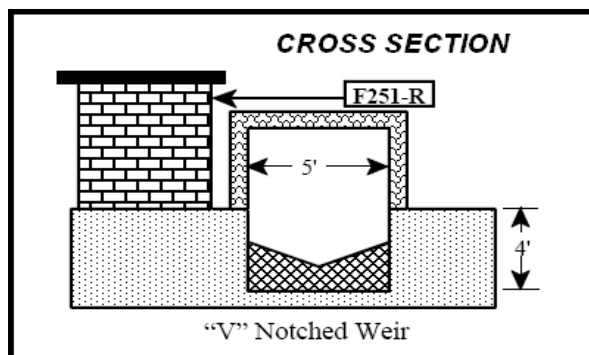
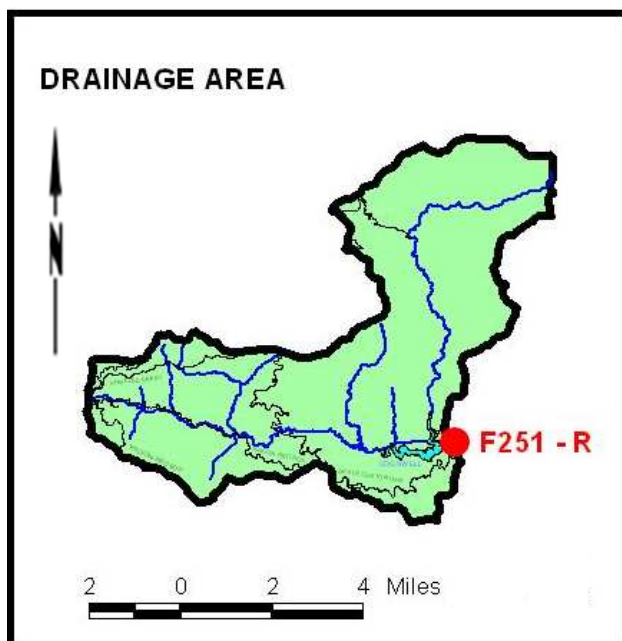

RECORDER - Continuous water stage.

METHOD OF MEASUREMENT - Wading

DRAINAGE AREA - 39.2 square miles.

LOCATION - About 200 feet below San Gabriel Dam No 2, and about 7 miles above the junction of the east and west Forks of the San Gabriel River.

REGULATION - Except for the bank runoff from a very small area below the dam, the flow is entirely regulated by San Gabriel Dam No 2.

DIVERSION - Water released from San Gabriel Dam No 2 enters river below station F251-R.

CHANNEL - Sand and gravel, natural section.

CONTROL - "V" notched weir.

LENGTH OF RECORD - Recorder records from April 26, 1935 to September 30, 1936 and from October 1974 to date.

REMARKS - None.

RUNOFF – STREAM GAGING STATION INFORMATION

SAN JOSE CHANNEL

Above Workman Mill Road.

STATION NO. F312B-R

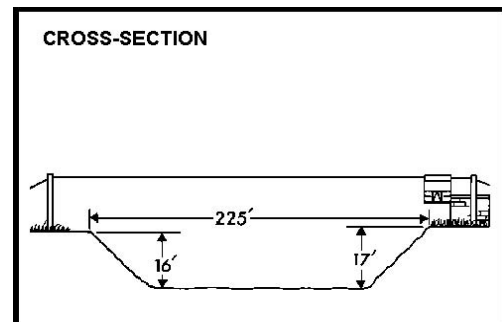
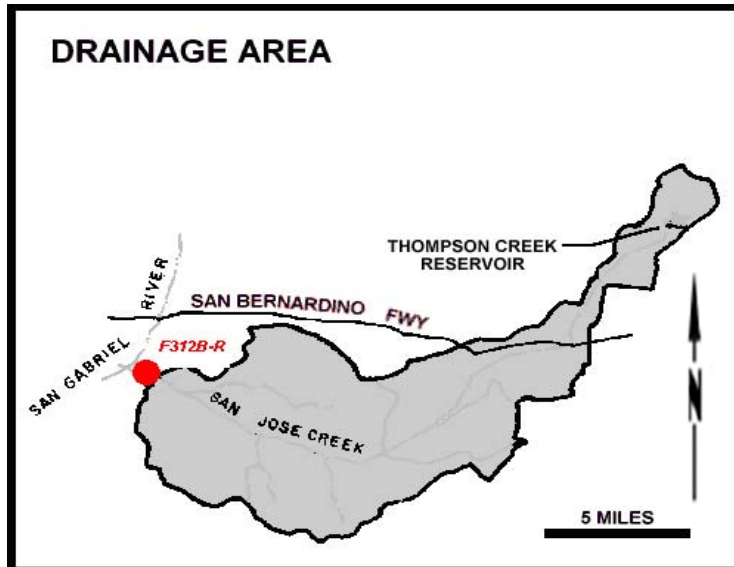

RECORDER - 5 min. interval data logger.

METHOD OF MEASUREMENT - Wading or from cable car.

DRAINAGE AREA - 83.4 square miles.

LOCATION - 1,650 feet above Workman Mill Road, 3.0 miles southeast of El Monte.

REGULATION - Partially regulated by Thompson Creek Dam and Pomona Sewage Treatment Plant.

DIVERSION - None.

CHANNEL - Grouted rip-rap side slopes with natural bottom, trapezoidal section.

CONTROL - Rock stabilizer.

LENGTH OF RECORD - September 13, 1955 to date.

REMARKS - None.

RUNOFF – STREAM GAGING STATION INFORMATION

SANTA ANITA WASH

Below Foothill Blvd.

STATION NO. F260C-R

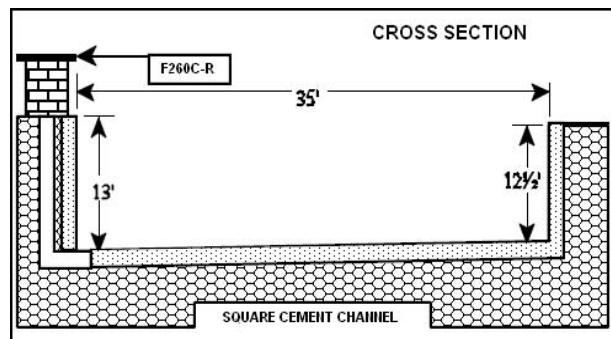
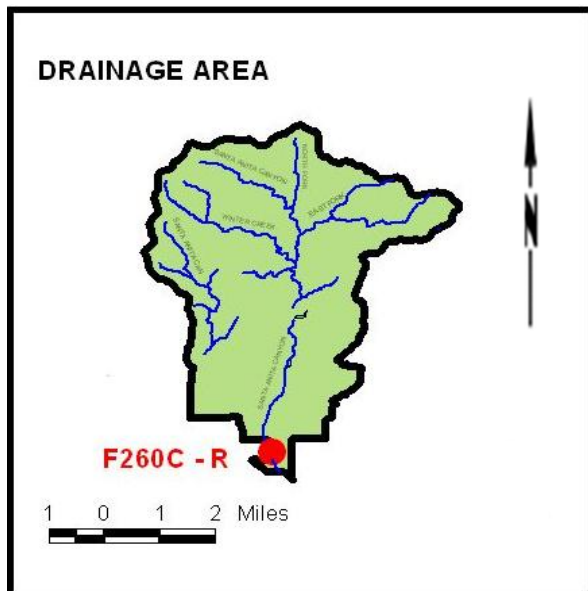

RECORDER - 5 min. interval data logger.

METHOD OF MEASUREMENT - Wading

DRAINAGE AREA 17.2 square miles.

LOCATION - Approximately 1/4 mile downstream from Foothill Blvd. in Arcadia. Located on the right bank of the Santa Anita Wash.

REGULATION - Flow partially regulated by Big Santa Anita Dam and Sierra Madre Dam.

DIVERSION - About 2 second feet diverted for irrigation at mouth of Santa Anita Canyon. The city of Sierra Madre diverts water from Sierra Madre Wash and Santa Anita Creek for spreading in Sierra Madre Spreading Grounds. The Flood Control District diverts water from Santa Anita Creek for spreading at mouth of Santa Anita Canyon.

CHANNEL - Concrete, rectangular section.

CONTROL - Channel forms control.

LENGTH OF RECORD - October 1, 1935 to October 1, 1938, and from October 1, 1957 to October 1, 1967, and from October 1, 1974 to date.

REMARKS - None.

RUNOFF – STREAM GAGING STATION INFORMATION

SANTA ANITA WASH

At Longden Avenue.

STATION NO. F193B-R

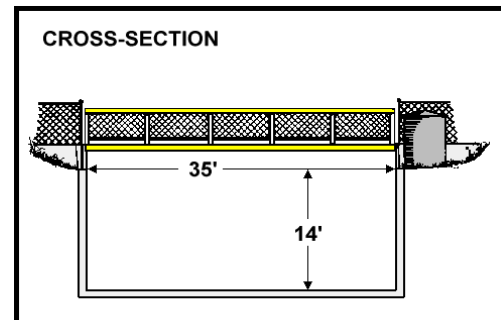
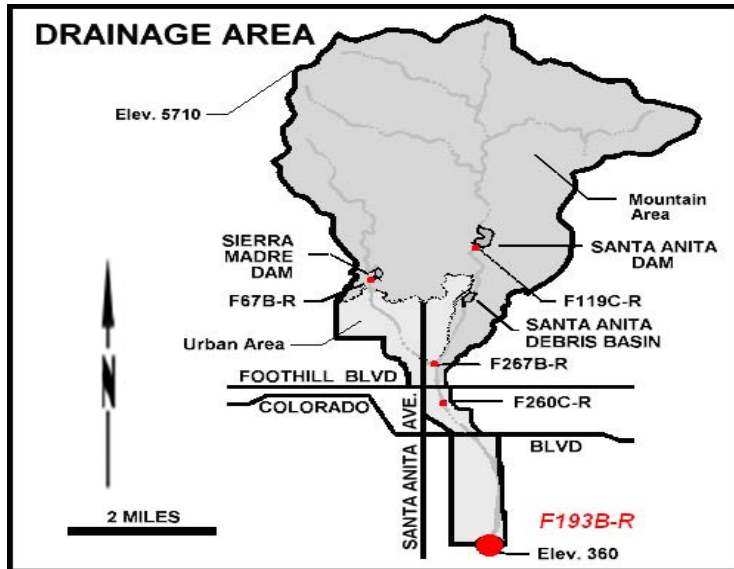

RECORDER - 5 min. interval data logger.

METHOD OF MEASUREMENT - Wading or from bridge.

DRAINAGE AREA - 18.8 square miles.

LOCATION - 30.0 feet above Longden Avenue, 1.5 miles south of Arcadia.

REGULATION - Regulated by Santa Anita and Sierra Madre Dams, and Santa Anita Debris Basin.

DIVERSION - None.

CHANNEL - Concrete, rectangular section, 35.0 feet wide by 14.0 feet deep.

CONTROL - Channel forms control.

LENGTH OF RECORD - At Station F193-R, April 25, 1932 to March 1, 1938; at Station F193B-R, January 5, 1960 to date.

REMARKS - None.

RUNOFF – STREAM GAGING STATION INFORMATION

SANTA CLARA RIVER

At Old Road Bridge.

STATION NO. F92C-R

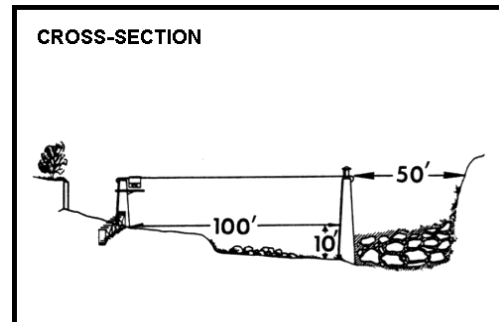
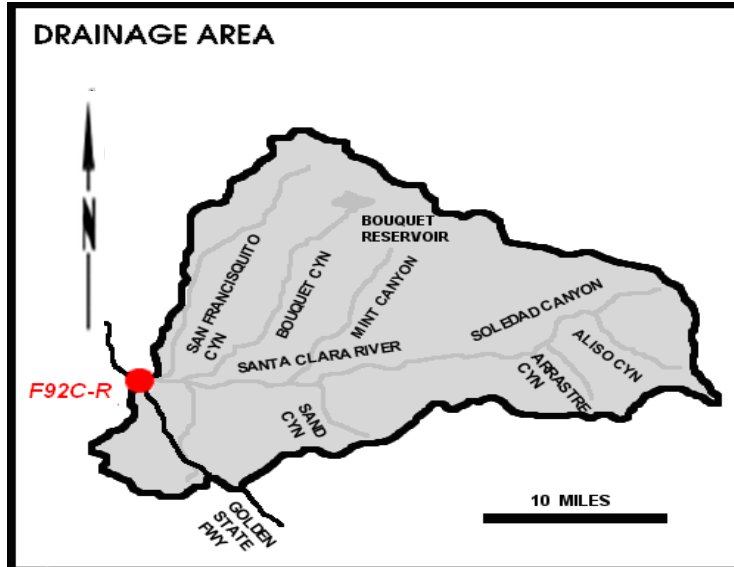

RECORDER - Continuous water stage.

METHOD OF MEASUREMENT - Stream Gaging or from bridge.

DRAINAGE AREA - 410.4 square miles.

LOCATION - Downstream side of Old Road bridge, 3 miles west of Saugus.

REGULATION - Partially regulated by Bouquet Canyon and Dry Canyon Reservoirs.

DIVERSION - None.

CHANNEL - Sand and gravel with brush, natural section.

CONTROL - None.

LENGTH OF RECORD - At station F92-R, January 18, 1930 to March 28, 1938 and September 24, 1956 to September 30, 1988; at station F92B-R, October 1, 1938 to September 24, 1956; at station F92C-R, October 1, 1988 to date.

REMARKS - Subject to diversions for irrigation. Station destroyed by flood of February 25, 1969 and then re-established.

RUNOFF – STREAM GAGING STATION INFORMATION

SANTA CLARA RIVER

At Capra Road Railroad Crossing.

STATION NO. F93C-R

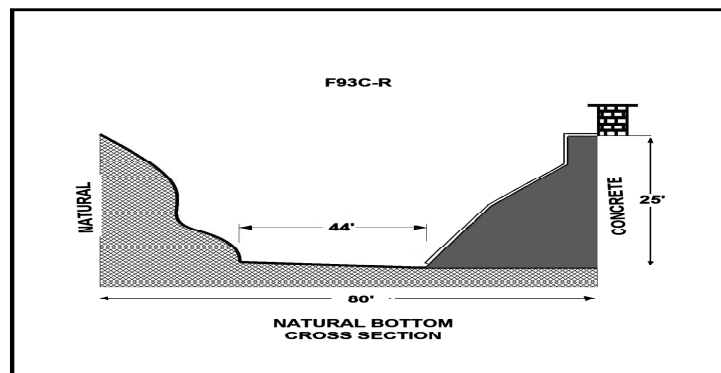
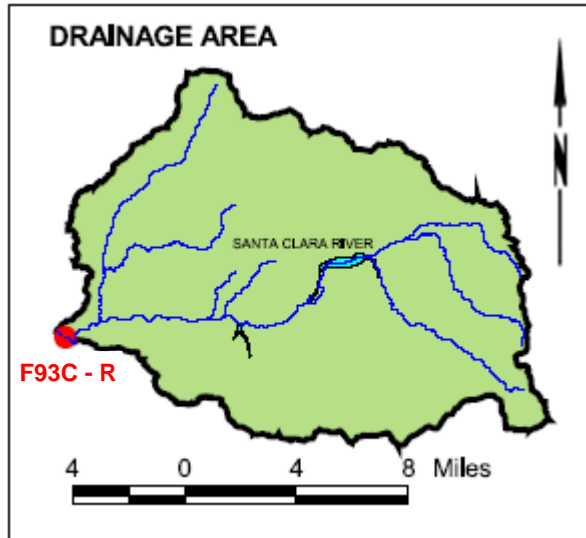

RECORDER - 5 min. interval data logger.

METHOD OF MEASUREMENT - Wading

DRAINAGE AREA - 157.0 square miles.

LOCATION - On right bank, 0.2 mi from railroad bridge, 1.8 mi downstream from Agua Dulce Canyon, and 1.0 mi southeast of Lang.

REGULATION - None.

DIVERSION - Small diversions for irrigation and recreation above station.

CHANNEL - Sand, gravel, and rock, natural section.

CONTROL - None.

LENGTH OF RECORD - At station F93-R, November 15, 1952 to October 1, 1968; at station F93B-R, October 1, 1969 to October 1, 1974; and February 2002 to date.

REMARKS - None.

RUNOFF – STREAM GAGING STATION INFORMATION

SANTA FE DIVERSION CHANNEL

Below Santa Fe Dam.

STATION NO. F280-R

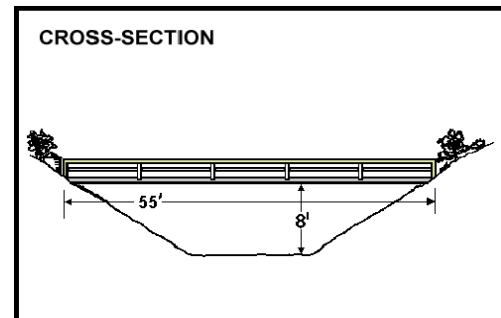
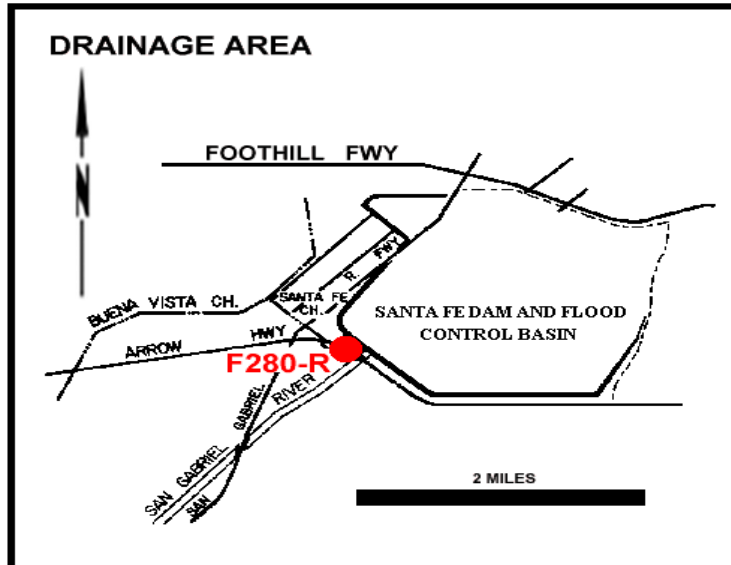

RECORDER - 5 min. interval data logger.

METHOD OF MEASUREMENT - Wading or from footbridge.

DRAINAGE AREA - Controlled square miles.

LOCATION - 400.0 feet downstream of Santa Fe Dam outlet and 1.5 miles north of Baldwin Park.

REGULATION - Flow regulated by five gates of stilling basin outlet of Santa Fe Dam.

DIVERSION - None.

CHANNEL - Sand and gravel, natural section.

CONTROL - Concrete stabilizer.

LENGTH OF RECORD - At Station F280-S, October 1, 1942 to May 12, 1944; at Station F280-R, May 12, 1944 to date.

REMARKS - None..

RUNOFF – STREAM GAGING STATION INFORMATION

SANTIAGO CANYON CREEK

Above Little Rock Creek.

STATION NO. F125-R

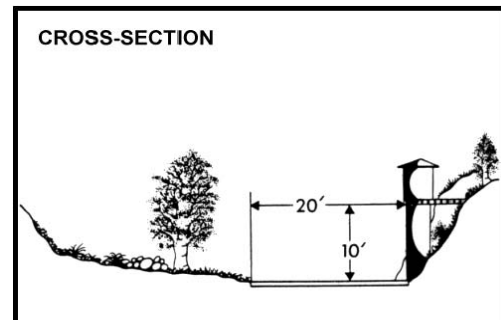
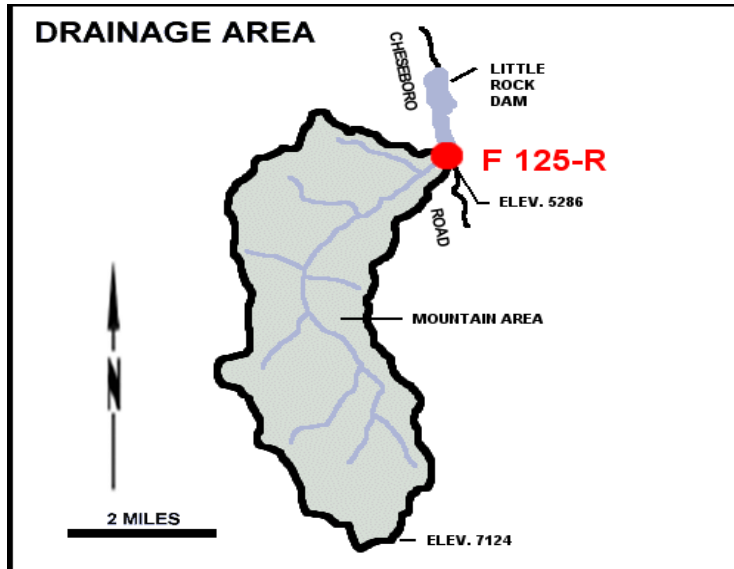

RECORDER - Continuous water stage.

METHOD OF MEASUREMENT - Wading

DRAINAGE AREA - 11.2 square miles.

LOCATION - 1,000 feet above Little Creek and 4.5 miles south of Little Rock.

REGULATION - None.

DIVERSION - None.

CHANNEL - Sand, gravel and boulders.

CONTROL - Concrete and rubble wall.

LENGTH OF RECORD - September 29, 1953 to date.

REMARKS - No high flow measurements.

RUNOFF – STREAM GAGING STATION INFORMATION

SAWPIT CREEK

Below Sawpit Dam.

STATION NO. F278-R

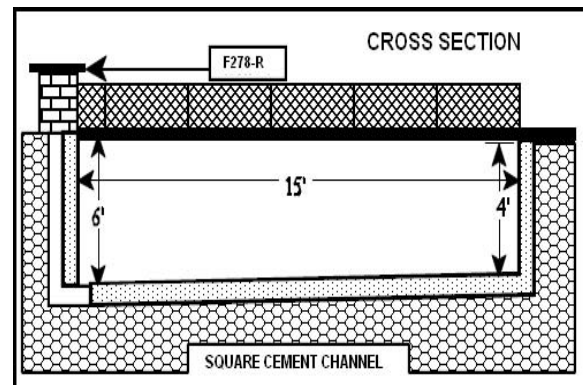
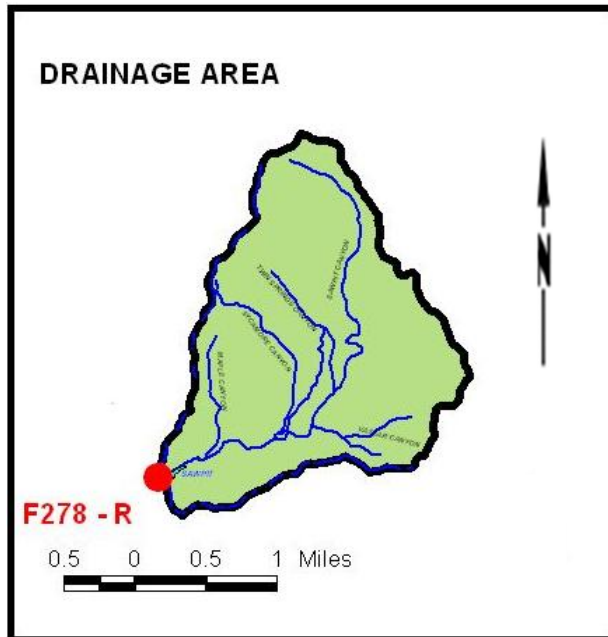

RECORDER - Continuous water stage.

METHOD OF MEASUREMENT - Wading or from footbridge.

DRAINAGE AREA 3.3 square miles.

LOCATION - On the right (north) side of the stream, about 500 feet downstream from Sawpit Dam and about 2.5 miles north of Monrovia. Elevation of gage 1199.27 feet.

REGULATION - Flow regulated by Sawpit Dam, station F278-R measures outlet discharge, spillway discharge enters Sawpit Creek below the station.

DIVERSION - City of Monrovia diverts flow above Sawpit Dam.

CHANNEL - Sand and gravel

CONTROL - A broad-crested weir forms the control.

LENGTH OF RECORD - October 1, 1941 to date.

REMARKS - None.

RUNOFF – STREAM GAGING STATION INFORMATION

SAWPIT WASH

Below Live Oak Avenue.

STATION NO. F194B-R

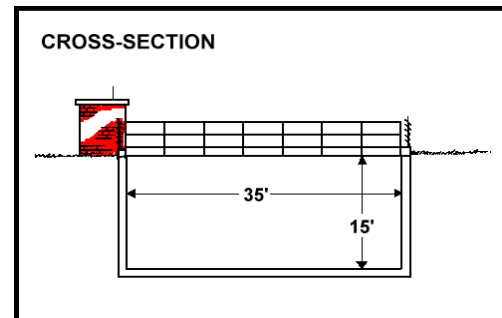
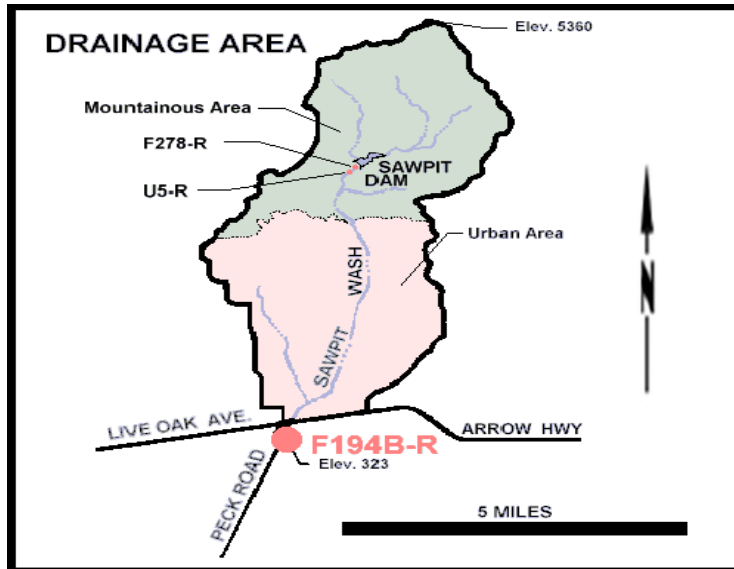

RECORDER - 5 min. interval data logger.

METHOD OF MEASUREMENT - Wading from footbridge.

DRAINAGE AREA - 16.1 square miles.

LOCATION - 1,500 feet below Live Oak Ave, 3.0 miles south of Monrovia.

REGULATION - Partially regulated by Sawpit and Santa Fe Dams, and several debris basins.

DIVERSION - None.

CHANNEL - Concrete, rectangular section, 35.0 feet wide by 15.0 feet deep.

CONTROL - Channel forms control.

LENGTH OF RECORD - At Station F194-R, February 22, 1932 to September 1, 1935; at Station F194B-R, December 5, 1960 to date.

REMARKS - None.

RUNOFF – STREAM GAGING STATION INFORMATION

THOMPSON CREEK

Below Thompson Creek Dam.

STATION NO. F32B-R

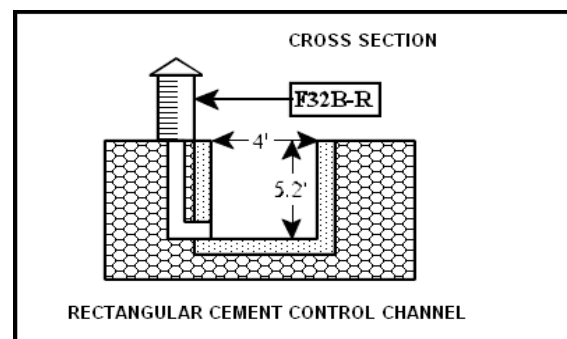
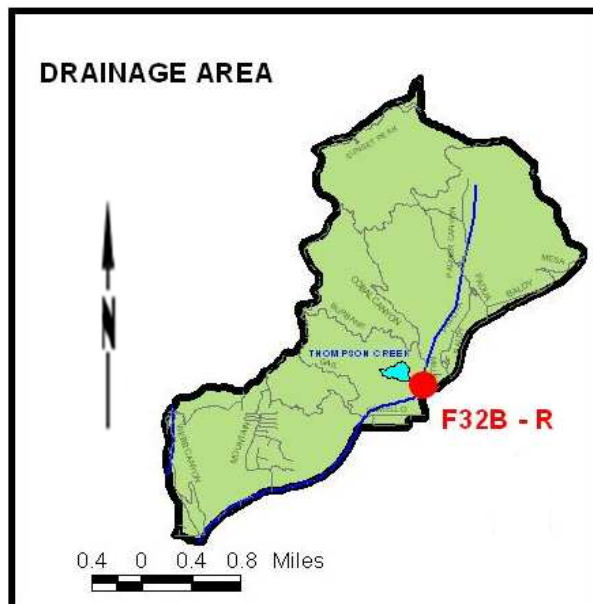

RECORDER - Continuous water stage.

METHOD OF MEASUREMENT - Wading

DRAINAGE AREA 3.7 square miles.

LOCATION - On the left (east) bank about 300 feet below Thompson Creek Dam tunnel outlet and about 2.5 miles north of Claremont. Elevation of zero gage height 1579.94 feet.

REGULATION - Inflow to Thompson Creek Dam from Cobal and Palmer Canyons can be directed through a 3-ft X 3-ft outlet tunnel to Thompson Creek Spreading Grounds.

DIVERSION - Flow through the diversion tunnel can be controlled by two slide gates so that any flow in excess of the capacity of gate openings is passed over a spillway back to the reservoir, flow through the 24 inch outlet valve passes the station, discharged over the spillway of the dam would not be recorded at this station.

CHANNEL - Natural channel.

CONTROL - San Dimas type flume.

LENGTH OF RECORD - October 1, 1945 to date.

REMARKS - None.

RUNOFF – STREAM GAGING STATION INFORMATION

TOPANGA CREEK

Above mouth of canyon.

STATION NO. F54C-R

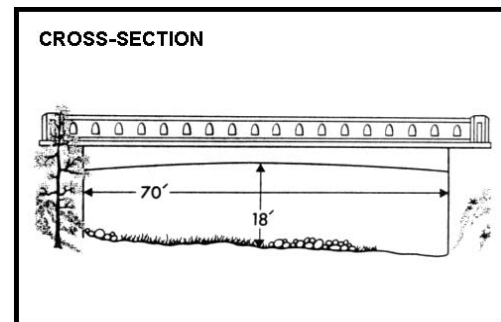
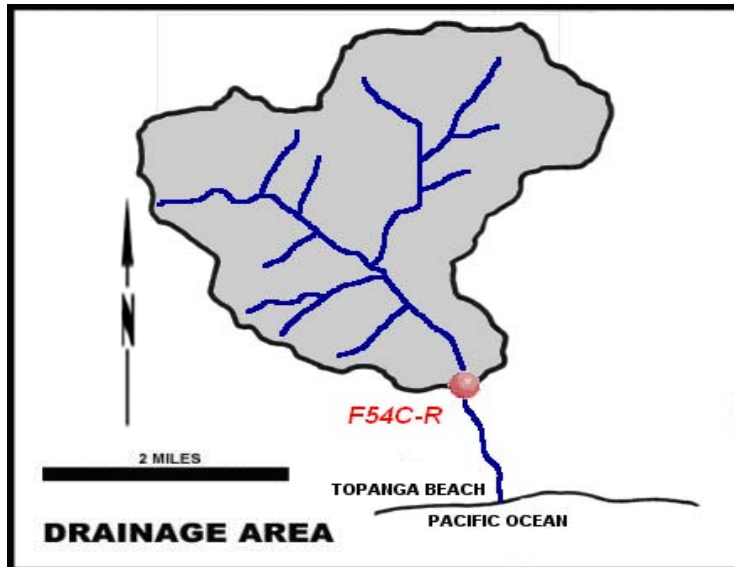

RECORDER - Continuous water stage.

METHOD OF MEASUREMENT - Wading

DRAINAGE AREA - 18.0 square miles.

LOCATION - Downstream side to Topanga Canyon Road bridge, 2.0 miles north of Topanga Beach.

REGULATION - None.

DIVERSION - Flow through the diversion tunnel can be controlled by TWO slide gates..

CHANNEL - Rock and gravel, natural section.

CONTROL - None.

LENGTH OF RECORD - At Station F54-R, January 1, 1930 to June 4, 1940; at Station F54B-R, June 5, 1940 to January 31, 1990; at Station F54C-R, October 1, 1997 to date.

REMARKS - None.

RUNOFF – STREAM GAGING STATION INFORMATION

VERDUGO WASH

At Estelle Avenue.

STATION NO. F252-R

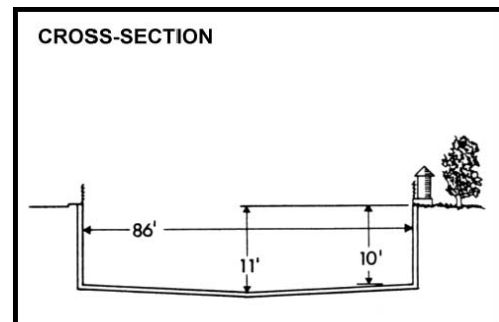
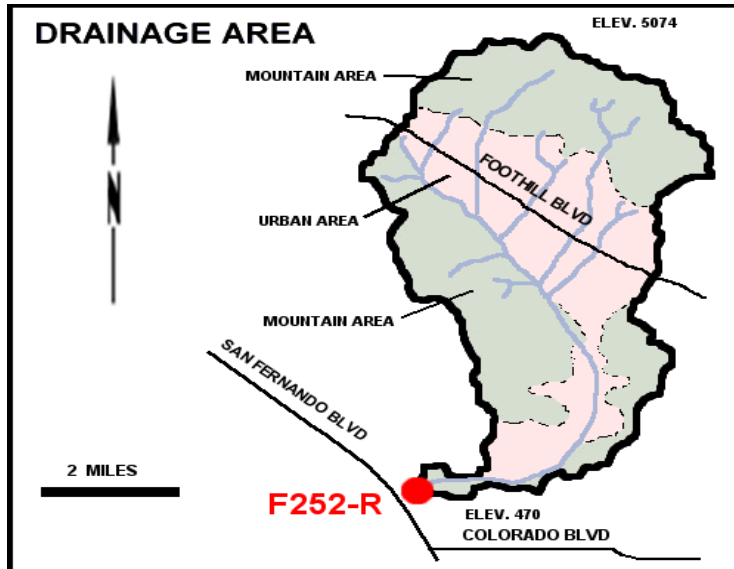

RECORDER - Continuous water stage.

METHOD OF MEASUREMENT - Wading or from Concord Street bridge.

DRAINAGE AREA - 26.8 square miles.

LOCATION - 800 feet east of San Fernando Road, 2.0 miles northwest of Glendale.

REGULATION - Partially regulated by several debris basins.

DIVERSION - None.

CHANNEL - Concrete, rectangular section.

CONTROL - Channel forms control.

LENGTH OF RECORD - December 2, 1935 to date.

REMARKS - None.

RUNOFF – STREAM GAGING STATION INFORMATION

WALNUT CREEK

Above Puente Avenue.

STATION NO. F304-R

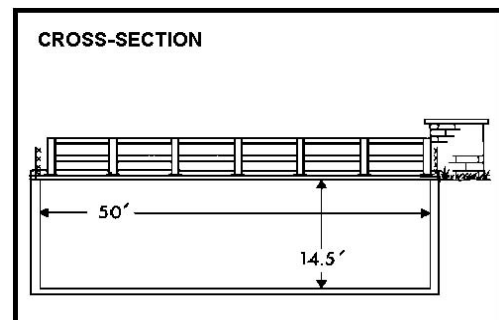
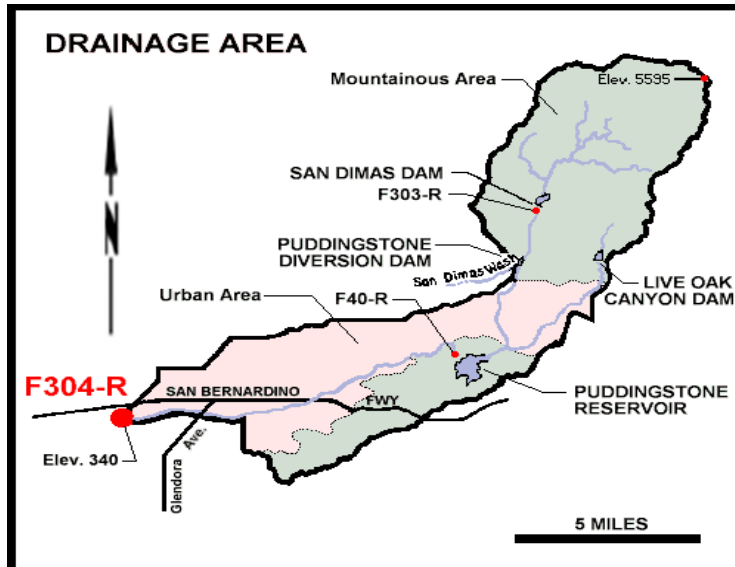

RECORDER - 5 min. interval data logger.

METHOD OF MEASUREMENT - Wading or from footbridge.

DRAINAGE AREA - 57.6 square miles.

LOCATION - 845.0 feet upstream of Puente Avenue bridge, Baldwin park.

REGULATION - Partially regulated by San Dimas, Puddingstone Diversion, Puddingstone, and Live Oak Dams.

DIVERSION - None.

CHANNEL - Concrete, rectangular section.

CONTROL - Channel forms control.

LENGTH OF RECORD - October 14, 1952 to April 11, 1961, January 3, 1962 to date.

REMARKS - No record during April 11, 1961 to January 3, 1962 due to channel construction.

RUNOFF – STREAM GAGING STATION INFORMATION

WALNUT CREEK

Below Puddingstone Dam.

STATION NO. F40-R

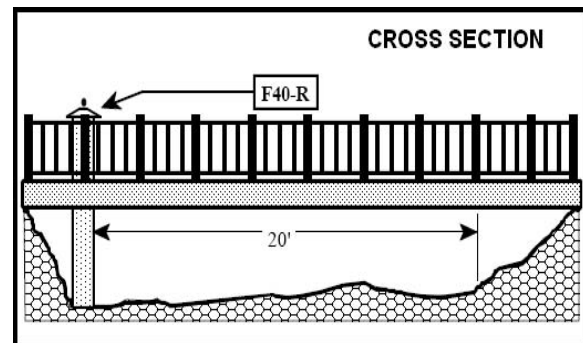
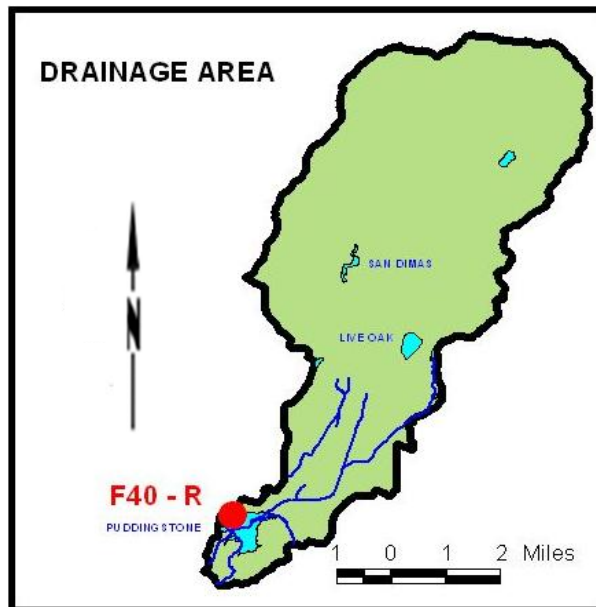

RECORDER - Continuous water stage.

METHOD OF MEASUREMENT - Wading or from cable car.

DRAINAGE AREA 33.2 square miles.

LOCATION - On the right (east) bank about 1000 feet below Puddingstone Dam near San Dimas. Elevation of zero gage height 824.90 feet.

REGULATION - Flow regulated by Puddingstone Dam.

DIVERSION - San Dimas Water Company diverts outflow from Dam above the station and also releases water to Puddingstone Diversion channel at Juanita street station F307-R, for purchase by Los Angeles County Parks and Recreation Department.

CHANNEL - Sand and gravel.

CONTROL - Concrete stabilizer.

LENGTH OF RECORD - October 1, 1931 to date.

REMARKS - None.

APPENDIX C

HYDROLOGIC REPORT 2014 – 2015

RUNOFF - DAILY DISCHARGE

RUNOFF – DAILY DISCHARGE

Los Angeles County Dept of Public works

USDAY V106 Output 03/16/2016

Summary Report

Site: F81D Alhambra Wash Near Klingerman Street
 USGS #:
 Beginning Date: 10/01/2014
 Ending Date: 09/30/2015

Daily Mean Discharge in Cubic feet/second water Year Oct 2014 to Sep 2015

Day	OCT	NOV	DEC	JAN	FEB	MAR	APR	MAY	JUN	JUL	AUG	SEP
1	1.83	53.0	8.83	2.63	.78	4.34	.36	.36	.35	.39	.36	.36
2	1.14	4.16	188	1.39	.51	40.1	.36	.36	.32	.40	.36	.36
3	.79	1.84	51.6	.84	.37	1.10	.36	.36	.34	.40	.36	.35
4	.60	.88	11.2	.61	.35	.54	.36	.35	.36	.40	.36	.32
5	.53	.67	4.55	.52	.35	.38	.36	.36	.39	.39	.36	.32
6	.41	.71	2.49	.44	.34	.34	.36	.36	.42	.36	.36	.32
7	.40	.64	1.48	.42	.36	.33	18.0	.36	.49	.38	.35	.32
8	.38	.67	.92	.39	.42	.35	4.26	13.0	.57	.39	.35	.32
9	.36	.64	.68	.42	.36	.34	.60	2.56	.75	.39	.35	.32
10	.36	.67	.52	26.8	.32	.37	.35	.92	.92	.39	.32	.32
11	.36	.71	.48	31.3	.32	.35	.34	.37	.99	.39	.32	.34
12	.36	.65	317	5.46	.31	.36	.37	.34	.87	.40	.32	.35
13	.36	.68	8.38	3.14	.31	.36	.36	.36	.73	.40	.32	.34
14	.36	.69	3.43	2.23	.30	.36	.36	99.3	.60	.40	.32	.32
15	.36	.71	1.82	1.63	.30	.36	.36	8.47	.47	.38	.34	301
16	.38	.72	15.7	1.33	.29	.36	.36	3.52	.36	.36	.34	6.53
17	.40	.73	53.7	1.28	.28	.37	.36	2.11	.33	.34	.32	3.10
18	.43	.75	5.17	1.14	.28	.40	.36	1.30	.32	10.2	.33	1.97
19	.49	.76	2.45	1.03	.27	.52	.36	.83	.35	10.4	.34	1.29
20	.55	.78	1.35	1.09	.27	.40	.35	.60	.36	6.61	.34	.88
21	.61	.79	.80	1.26	.26	.39	.36	.50	.35	1.97	.36	.69
22	.67	.80	.57	1.36	64.5	.37	.36	.39	.32	.53	.36	.52
23	.74	.82	.52	1.50	10.7	.36	.36	.37	.32	.34	.36	.51
24	.82	.77	.40	1.28	3.14	.36	.36	.36	.32	.32	.36	.40
25	.90	.59	.37	1.25	1.30	.36	22.8	.36	.33	.32	.36	.36
26	.98	.49	.36	12.5	.66	.38	3.13	.36	.34	.33	.36	.36
27	1.07	.42	.33	9.78	.37	.40	.51	.36	.35	.37	.36	.36
28	1.16	.38	.32	4.21	1.90	.39	.30	.36	.36	.38	.36	.34
29	1.07	.35	.32	2.48	-----	.36	.32	.36	.37	.36	.36	.33
30	.74	15.0	18.6	2.00	-----	.36	.37	.36	.38	.36	.36	.32
31	7.35	-----	7.24	1.25	-----	.37	-----	.36	-----	.36	.36	-----
Total	26.96	91.47	709.58	122.96	89.92	56.13	57.82	140.33	13.73	39.41	10.78	323.62
Mean	.87	3.05	22.9	3.97	3.21	1.81	1.93	4.53	.46	1.27	.35	10.8
Max	7.35	53.0	317	31.3	64.5	40.1	22.8	99.3	.99	10.4	.36	301
Min	.36	.35	.32	.39	.26	.33	.30	.34	.32	.32	.32	.32
Acre-Ft	53	181	1410	244	178	111	115	278	27	78	21	642
wtr Year 2015	Total	1682.71	Mean	4.61	Max	317	Min	.26	Inst Max	5950	Acre-Ft	3340
Cal Year 2014	Total	1681.43	Mean	4.61	Max	346	Min	.32	Inst Max	5950	Acre-Ft	3340

RUNOFF – DAILY DISCHARGE

Los Angeles County Dept of Public works

USDAY V106 Output 03/16/2016

Summary Report

Site: F317 Arcadia Wash Below Grand Avenue
 USGS #:
 Beginning Date: 10/01/2014
 Ending Date: 09/30/2015

Daily Mean Discharge in Cubic feet/second Water Year Oct 2014 to Sep 2015

Day	OCT	NOV	DEC	JAN	FEB	MAR	APR	MAY	JUN	JUL	AUG	SEP
1	.65	36.3	3.89	.26	.39	1.13	.31	.34	.17	.33	.49	.30
2	.67	.71	133	.31	.39	24.4	.35	.36	.21	.26	.30	.24
3	.60	.67	71.9	.29	.33	.37	.27	.33	.26	.22	.20	.44
4	.60	2.97	10.6	.26	.30	.26	.22	.29	.31	.14	.39	.36
5	.59	.90	3.50	.33	.34	.24	.24	.29	.20	.18	1.10	.32
6	.69	.71	3.06	.24	.28	.28	.26	.34	.16	.25	.39	.30
7	.61	.53	2.61	.32	1.42	.24	16.6	.68	.11	.28	.39	.42
8	.71	.60	2.15	.36	.33	.19	.37	10.2	.20	.35	.35	.40
9	.74	.56	1.22	.41	.44	.34	.40	.28	.28	.37	.42	.46
10	.67	.60	.41	19.2	.38	.30	.38	.26	.27	.24	.36	.54
11	.68	.61	.42	54.9	.32	.32	.36	.24	.29	.28	.36	.65
12	.67	.66	161	.56	.33	.31	.33	.37	.32	.27	.39	.43
13	.64	.68	.59	.38	.33	.35	.38	.25	.29	.28	.41	.44
14	.70	.73	.31	.33	.27	.25	.39	68.2	.23	.27	.40	.36
15	.66	.72	.37	.32	.31	.31	.44	.72	.23	.30	.47	139
16	.65	.63	4.32	.27	.56	.40	.24	.33	.28	.38	.36	4.51
17	.75	.66	54.6	.28	.47	.26	.29	.26	.21	.43	.62	.37
18	.63	.91	.43	.29	.34	.52	.14	.23	.23	5.02	.61	.28
19	.63	.70	.26	.36	.39	.35	.06	.19	.28	20.8	.39	.33
20	.91	.64	.25	.43	.33	.41	.19	.23	.20	.59	.36	.31
21	.76	13.0	.26	.34	.35	.39	.41	.23	.16	.32	.34	.30
22	.63	.61	.39	.30	57.3	.34	.28	.26	.20	.22	.34	.33
23	.60	.63	.27	.34	31.8	.43	.30	.21	.25	.25	.31	.33
24	.63	.60	.28	.35	.48	.34	.31	.25	.18	.17	.35	7.93
25	.70	.63	.20	.27	.28	.22	13.4	.19	.23	.23	.37	.30
26	.71	.67	.30	5.01	.29	.27	.34	.26	.24	.24	.41	.39
27	.66	.61	.35	.51	.55	.29	.33	.20	.25	.22	.42	.37
28	.61	.66	.39	.42	1.30	.28	.43	.21	.23	.24	.37	.32
29	.87	.70	.34	.37	-----	.24	.40	.19	.28	.30	.37	.32
30	.66	45.8	19.8	.40	-----	.34	.35	.18	.30	.41	.35	.35
31	12.3	-----	.35	.40	-----	.35	-----	.18	-----	.22	.28	-----
Total	32.58	115.40	477.82	88.81	100.60	34.72	38.77	86.75	7.05	34.06	12.67	161.40
Mean	1.05	3.85	15.4	2.86	3.59	1.12	1.29	2.80	.24	1.10	.41	5.38
Max	12.3	45.8	161	54.9	57.3	24.4	16.6	68.2	.32	20.8	1.10	139
Min	.59	.53	.20	.24	.27	.19	.06	.18	.11	.14	.20	.24
Acre-Ft	65	229	948	176	200	69	77	172	14	68	25	320
Wtr Year 2015	Total	1190.63	Mean	3.26	Max	161	Min	.06	Inst Max	3270	Acre-Ft	2360
Cal Year 2014	Total	1268.81	Mean	3.48	Max	239	Min	.20	Inst Max	3270	Acre-Ft	2520

RUNOFF – DAILY DISCHARGE

Los Angeles County Dept of Public works

USDAY V106 Output 03/16/2016

Summary Report

Site: F277 Arroyo Seco Below Devil's Gate Dam
 USGS #:
 Beginning Date: 10/01/2014
 Ending Date: 09/30/2015

Daily Mean Discharge in Cubic feet/second water Year Oct 2014 to Sep 2015

Day	OCT	NOV	DEC	JAN	FEB	MAR	APR	MAY	JUN	JUL	AUG	SEP
1	0	6.32	.65	.58	.50	.48	.04	0	0	0	0	0
2	0	0	2.80	.57	.47	.67	.03	0	0	0	0	0
3	0	0	.65	.56	.45	.40	.03	0	0	0	0	0
4	0	0	.53	.55	.44	.39	.02	0	0	0	0	0
5	0	0	.47	.54	.40	.39	.01	0	0	0	0	0
6	0	0	.48	.54	.40	.38	0	0	0	0	0	0
7	0	0	.45	.53	.38	.38	0	0	0	0	0	0
8	0	0	.40	.53	.38	.38	0	0	0	0	0	0
9	0	0	.41	.55	.38	.38	0	0	0	0	0	0
10	0	0	.39	.64	.38	.38	0	0	0	0	0	0
11	0	0	.42	.62	.38	.38	0	0	0	0	0	0
12	0	0	4.25	.60	.39	.37	0	0	0	0	0	0
13	0	0	.50	.61	.39	.35	0	0	0	0	0	0
14	0	0	.42	.61	.40	.33	0	.96	0	0	0	0
15	0	0	.44	.61	.40	.32	0	.66	0	0	0	27.3
16	0	0	.80	.60	.41	.30	0	.62	0	0	0	.34
17	0	0	1.53	.59	.41	.28	0	.61	0	0	0	0
18	0	0	.54	.58	.42	.26	0	.58	0	0	0	0
19	0	0	.56	.58	.42	.23	0	.56	0	.39	0	0
20	0	0	.56	.58	.43	.21	0	.52	0	.08	0	0
21	0	0	.55	.55	.43	.18	0	.47	0	.18	0	0
22	0	0	.55	.57	.55	.15	0	.19	0	.26	0	0
23	0	0	.55	.56	.75	.12	0	0	0	.28	0	0
24	0	0	.55	.54	.40	.11	0	0	0	.28	0	0
25	0	0	.57	.53	.38	.10	0	0	0	.29	0	0
26	0	0	.59	.51	.40	.09	0	0	0	.29	0	0
27	0	0	.60	.50	.41	.08	0	0	0	.30	0	0
28	0	0	.59	.51	.43	.07	0	0	0	.30	0	0
29	0	0	.59	.50	-----	.07	.06	0	0	23.0	0	0
30	0	2.25	.59	.50	-----	.06	0	0	0	10.8	0	0
31	0	-----	.58	.49	-----	.05	-----	0	-----	0	0	-----
Total	0	8.57	23.56	17.33	11.98	8.34	0.19	5.17	0	36.45	0	27.64
Mean	0	.29	.76	.56	.43	.27	.006	.17	0	1.18	0	.92
Max	0	6.32	4.25	.64	.75	.67	.06	.96	0	23.0	0	27.3
Min	0	0	.39	.49	.38	.05	0	0	0	0	0	0
Acre-Ft	0	17	47	34	24	17	.38	10	0	72	0	55
wtr Year 2015	Total	139.23	Mean	.38	Max	27.3	Min	0	Inst Max	200	Acre-Ft	276
Cal Year 2014	Total	243.85	Mean	.67	Max	133	Min	0	Inst Max	298	Acre-Ft	484

RUNOFF – DAILY DISCHARGE

Los Angeles County Dept of Public works

USDAY V106 Output 03/16/2016

Summary Report

Site: F38C Ballona Creek Above Sawtelle Boulevard
 USGS #:
 Beginning Date: 10/01/2014
 Ending Date: 09/30/2015

Daily Mean Discharge in Cubic feet/second water Year Oct 2014 to Sep 2015

Day	OCT	NOV	DEC	JAN	FEB	MAR	APR	MAY	JUN	JUL	AUG	SEP
1	8.00	296	17.6	15.5	6.55	441	7.04	4.73	16.2	8.52	9.04	20.2
2	7.74	4.44	1210	16.1	6.16	404	6.96	4.63	17.3	5.80	8.30	10.2
3	6.41	4.25	114	15.9	6.99	25.0	7.11	4.84	18.3	2.97	8.63	5.73
4	6.07	4.67	13.6	15.1	5.97	7.24	7.20	5.26	18.6	1.60	8.62	5.95
5	6.74	4.59	7.26	11.5	6.45	6.97	7.01	5.75	14.5	3.25	8.73	6.43
6	11.4	4.56	7.74	7.01	6.92	6.64	7.74	6.37	12.5	3.43	7.14	9.17
7	8.84	4.54	6.33	6.17	8.43	6.82	212	9.69	12.0	3.55	7.44	8.41
8	7.65	4.50	7.93	7.75	8.94	5.97	10.8	71.0	8.17	3.59	7.09	8.91
9	6.58	4.42	7.09	8.71	8.78	5.98	8.41	5.64	6.34	5.10	7.40	6.70
10	7.12	4.79	6.41	289	9.52	6.04	8.20	6.43	5.16	3.17	7.30	7.63
11	6.97	4.67	6.62	505	10.1	5.85	8.34	5.96	5.72	3.02	7.51	6.75
12	8.39	4.67	1770	9.98	10.2	5.65	8.04	4.98	5.14	3.06	7.13	7.27
13	7.96	4.80	10.2	8.77	10.9	5.66	7.94	5.53	4.58	3.21	6.38	7.60
14	8.59	4.66	7.79	10.1	10.2	5.06	6.02	395	4.84	4.18	6.22	7.10
15	8.12	4.84	7.87	17.1	10.4	5.16	5.17	17.3	4.07	4.27	5.92	2080
16	8.07	4.37	187	16.8	10.8	5.52	5.05	5.19	4.50	4.70	7.60	7.94
17	12.5	4.74	232	21.0	12.6	5.51	4.90	7.16	4.89	6.17	6.17	6.79
18	15.7	4.93	10.7	21.9	23.9	5.80	4.68	6.19	4.43	184	6.60	5.94
19	7.92	5.19	10.9	19.9	10.8	5.88	4.69	6.67	4.29	19.0	7.00	5.64
20	7.72	5.57	12.4	17.5	9.50	5.86	5.04	7.45	4.68	5.38	6.68	5.63
21	8.26	5.05	11.9	16.6	9.63	6.69	4.97	10.4	4.61	3.12	6.86	5.72
22	8.52	5.02	11.8	16.7	355	6.14	5.39	11.6	5.30	2.74	6.36	5.62
23	10.2	6.05	10.4	16.3	59.8	6.53	4.80	12.9	6.15	1.96	6.30	5.54
24	9.54	5.75	9.50	17.3	8.49	7.45	4.70	13.3	6.55	2.58	6.35	5.97
25	10.9	8.64	9.62	18.5	8.05	6.65	8.25	13.3	6.99	3.10	6.57	6.63
26	10.1	8.18	10.8	36.3	7.71	6.64	4.55	14.5	8.15	5.09	6.49	6.71
27	11.0	7.95	9.84	15.0	8.06	6.57	4.01	15.3	5.36	5.96	7.70	5.93
28	10.2	8.31	9.42	7.12	75.6	6.56	4.64	15.3	5.00	7.26	6.75	7.05
29	10.6	8.62	10.9	6.58	-----	7.16	4.87	17.0	9.37	8.78	6.20	8.92
30	11.8	396	118	30.5	-----	7.86	4.52	16.6	8.70	9.07	6.34	8.55
31	33.2	-----	20.9	7.53	-----	6.90	-----	14.5	-----	8.83	14.4	-----
Total	302.81	844.77	3886.52	1229.22	726.45	1046.76	393.04	740.47	242.39	336.46	227.22	2296.63
Mean	9.77	28.2	125	39.7	25.9	33.8	13.1	23.9	8.08	10.9	7.33	76.6
Max	33.2	396	1770	505	355	441	212	395	18.6	184	14.4	2080
Min	6.07	4.25	6.33	6.17	5.97	5.06	4.01	4.63	4.07	1.60	5.92	5.54
Acre-Ft	601	1680	7710	2440	1440	2080	780	1470	481	667	451	4560
wtr Year 2015	Total	12272.74	Mean	33.6	Max	2080	Min	1.60	Inst Max	11700	Acre-Ft	24340
Cal Year 2014	Total	14617.10	Mean	40.0	Max	2560	Min	4.25	Inst Max	10400	Acre-Ft	28990

RUNOFF – DAILY DISCHARGE

Los Angeles County Dept of Public works

USDAY V106 Output 03/16/2016

Summary Report

Site: F120B Big Dalton Creek Below Big Dalton Dam
 USGS #:
 Beginning Date: 10/01/2014
 Ending Date: 09/30/2015

Daily Mean Discharge in Cubic feet/second water Year Oct 2014 to Sep 2015

Day	OCT	NOV	DEC	JAN	FEB	MAR	APR	MAY	JUN	JUL	AUG	SEP
1	0	0	0	.10	.50	.10	0	.82	.11	0	0	0
2	0	0	.44	.10	.45	.10	0	.16	.11	0	0	0
3	0	0	1.23	.10	.36	.10	0	.20	.10	0	0	0
4	0	0	1.24	.10	.32	.10	0	.18	.10	0	0	0
5	0	0	.57	.10	.28	.10	0	.20	.10	0	0	0
6	0	0	.10	.10	.24	.04	0	.13	.10	0	0	0
7	0	0	.10	.10	.20	.05	0	.14	.10	0	0	0
8	0	0	.10	.10	.16	.10	0	.23	.04	0	0	0
9	0	0	.02	.10	.12	.10	0	.17	.04	0	0	0
10	0	0	0	.10	.08	.10	0	.14	.10	0	0	0
11	0	0	0	.17	.03	.10	0	.12	.10	0	0	0
12	0	0	.26	.20	0	.10	0	.10	.10	0	0	0
13	0	0	.10	.20	0	.05	0	.10	.10	0	0	0
14	0	0	.10	.20	0	0	0	.26	.10	0	0	0
15	0	0	.10	.20	0	0	0	.24	.08	0	0	0
16	0	0	.10	.20	0	0	0	.20	.04	0	0	0
17	0	0	.25	.20	0	0	0	.20	0	0	0	0
18	0	0	.20	.16	0	0	0	.19	0	0	0	0
19	0	0	.20	.10	0	0	0	.19	0	0	0	0
20	0	0	.20	.10	0	0	0	.18	0	0	0	0
21	0	0	.20	.10	0	0	0	.18	0	0	0	0
22	0	0	.10	.10	0	0	0	.17	0	0	0	0
23	0	0	.10	.05	0	0	0	.16	0	0	0	0
24	0	0	.10	0	0	0	0	.16	0	0	0	0
25	0	0	.10	0	0	0	0	.15	0	0	0	0
26	0	0	.10	.08	.03	0	0	.15	0	0	0	0
27	0	0	.10	.40	.10	0	0	.14	0	0	0	0
28	0	0	.10	.49	.10	0	0	.13	0	0	0	0
29	0	0	.10	.50	-----	0	0	.13	0	0	0	0
30	0	0	.10	.50	-----	0	1.94	.12	0	0	0	0
31	0	-----	.10	.50	-----	0	-----	.12	-----	0	0	-----
Total	0	0	6.51	5.45	2.97	1.14	1.94	5.76	1.42	0	0	0
Mean	0	0	.21	.18	.11	.037	.065	.19	.047	0	0	0
Max	0	0	1.24	.50	.50	.10	1.94	.82	.11	0	0	0
Min	0	0	0	0	0	0	0	.10	0	0	0	0
Acre-Ft	0	0	13	11	5.9	2.3	3.8	11	2.8	0	0	0
wtr Year 2015	Total	25.19	Mean	.069	Max	1.94	Min	0	Inst Max	3.63	Acre-Ft	50
Cal Year 2014	Total	31.18	Mean	.085	Max	3.97	Min	0	Inst Max	9.35	Acre-Ft	62

RUNOFF – DAILY DISCHARGE

Los Angeles County Dept of Public works

USDAY V106 Output 03/16/2016

Summary Report

Site: F394 Big Rock Creek Upstream from Pallett Creek
 USGS #:
 Beginning Date: 10/01/2014
 Ending Date: 09/30/2015

Daily Mean Discharge in Cubic feet/second water Year Oct 2014 to Sep 2015

Day	OCT	NOV	DEC	JAN	FEB	MAR	APR	MAY	JUN	JUL	AUG	SEP
1	0	0	0	1.00	.67	.59	.66	2.35	1.78	5.26	12.6	2.21
2	0	0	0	1.00	.73	.58	.64	1.85	2.01	3.31	9.41	2.16
3	0	0	0	1.00	.79	.54	.66	1.81	2.00	1.57	4.93	2.09
4	0	0	0	1.00	.76	.50	.66	1.62	1.89	1.35	1.03	1.94
5	0	0	0	1.02	.69	.47	.71	1.42	1.64	1.43	.98	1.83
6	0	0	0	.93	.64	.46	.75	1.28	2.02	1.53	1.06	1.72
7	0	0	0	.46	.58	.43	.73	1.19	1.92	1.79	1.14	1.62
8	0	0	0	.22	.57	.44	.73	1.42	1.71	1.78	.95	1.47
9	0	0	0	.21	.48	.35	.72	1.50	3.09	1.96	.93	4.77
10	0	0	0	.24	.40	.30	.71	1.47	2.35	1.98	.92	17.2
11	0	0	7.43	.33	.35	.37	.71	1.33	2.29	1.83	.90	1.93
12	0	0	70.3	.32	.42	.43	.74	1.19	2.39	1.69	.90	1.50
13	0	0	18.4	.31	.49	.48	.78	1.11	1.91	1.62	.91	1.67
14	0	0	14.9	.30	.58	.57	.78	1.17	1.58	1.55	.94	1.53
15	0	0	13.6	.29	.68	.65	.77	1.17	1.22	1.49	.92	22.6
16	0	0	12.4	.31	.80	.78	.85	1.19	1.05	1.41	.92	5.59
17	0	0	10.7	.35	.94	.65	1.01	1.36	1.08	1.35	.92	1.14
18	0	0	8.20	.36	.58	.51	1.00	1.45	1.05	2.97	.95	1.06
19	0	0	7.03	.42	.18	.54	.99	1.49	1.04	15.7	.95	1.05
20	0	0	6.61	.43	.30	.58	.98	1.63	1.02	49.4	1.01	1.08
21	0	0	6.02	.40	.43	.59	.99	1.58	1.01	29.6	1.17	1.12
22	0	0	4.76	.39	.55	.66	1.10	1.79	1.01	14.7	1.21	1.11
23	0	0	3.49	.40	.76	.67	1.03	1.84	1.37	7.07	1.32	1.11
24	0	0	2.22	.43	.79	.68	1.06	1.73	2.06	2.88	1.42	1.24
25	0	0	1.36	.48	.69	.74	1.54	1.38	1.78	1.79	1.64	2.06
26	0	0	1.31	.60	.66	.75	2.05	1.21	1.74	1.28	1.59	2.00
27	0	0	1.18	.74	.62	.80	1.46	1.28	1.73	1.17	1.60	1.89
28	0	0	1.11	.87	.59	.82	1.27	1.41	1.78	1.11	1.68	1.66
29	0	0	1.00	.83	-----	.78	1.38	1.41	1.79	1.10	1.63	1.39
30	0	0	.82	.73	-----	.72	1.47	1.45	1.75	22.1	1.87	1.30
31	0	-----	1.00	.70	-----	.71	-----	1.68	-----	25.8	2.19	-----
Total	0	0	193.84	17.07	16.72	18.14	28.93	45.76	51.06	209.57	60.59	91.04
Mean	0	0	6.25	.55	.60	.59	.96	1.48	1.70	6.76	1.95	3.03
Max	0	0	70.3	1.02	.94	.82	2.05	2.35	3.09	49.4	12.6	22.6
Min	0	0	0	.21	.18	.30	.64	1.11	1.01	1.10	.90	1.05
Acre-Ft	0	0	384	34	33	36	57	91	101	416	120	181
wtr Year 2015	Total	732.72	Mean	2.01	Max	70.3	Min	0	Inst Max	306	Acre-Ft	1450
Cal Year 2014	Total	832.59	Mean	2.28	Max	235	Min	0	Inst Max	1080	Acre-Ft	1650

RUNOFF – DAILY DISCHARGE

Los Angeles County Dept of Public works

USDAY V106 Output 03/16/2016

Summary Report

Site: F168B Big Tujunga Creek below Big Tujunga Dam
 USGS #:
 Beginning Date: 10/01/2014
 Ending Date: 09/30/2015

Daily Mean Discharge in Cubic feet/second Water Year Oct 2014 to Sep 2015

Day	OCT	NOV	DEC	JAN	FEB	MAR	APR	MAY	JUN	JUL	AUG	SEP
1	2.29	2.02	1.79	1.74	1.78	1.91	1.91	1.75	1.87	1.92	1.89	2.31
2	1.67	1.33	2.21	1.74	1.82	1.65	1.93	1.95	1.84	1.85	2.10	2.29
3	1.70	1.32	1.78	1.72	1.90	1.60	1.85	2.21	1.92	1.84	2.00	2.34
4	1.34	1.49	1.63	1.70	1.99	1.78	1.58	2.27	1.79	1.80	2.00	2.40
5	1.08	1.61	1.63	1.64	2.05	1.72	1.48	2.21	1.88	1.87	1.97	2.32
6	1.14	1.70	1.72	1.62	2.11	1.59	1.37	2.06	2.00	1.97	1.87	2.45
7	1.72	1.72	1.79	1.63	2.25	1.53	1.52	5.84	1.83	2.04	1.96	2.55
8	1.61	1.72	1.82	1.60	2.25	1.42	1.45	2.82	1.65	2.31	1.95	2.11
9	1.20	1.73	1.89	1.67	2.31	1.44	1.42	1.84	1.59	2.28	1.98	2.25
10	1.02	1.85	2.04	1.82	2.29	1.53	1.54	1.97	1.61	2.20	2.11	2.25
11	1.04	1.99	2.18	2.05	2.16	1.50	1.75	1.88	1.83	2.05	1.89	2.50
12	1.25	1.77	3.66	1.84	2.00	1.35	1.81	2.19	1.80	1.97	1.63	2.71
13	1.17	1.57	1.86	1.84	1.97	1.37	1.57	2.56	1.68	1.92	1.70	2.55
14	1.16	1.60	1.73	1.85	1.87	1.57	1.71	3.02	1.73	1.94	1.85	2.58
15	1.45	1.72	1.64	1.76	2.00	1.69	1.87	2.87	1.77	1.97	2.05	2.68
16	1.43	1.55	1.66	1.70	1.77	1.75	1.73	2.98	1.73	1.96	1.93	2.12
17	1.78	1.52	1.89	1.67	1.50	1.76	1.71	2.94	1.65	1.83	1.91	2.11
18	1.31	3.26	1.67	1.72	1.87	1.76	1.72	2.91	1.58	2.00	1.86	2.03
19	1.56	2.18	1.65	1.75	2.06	1.66	1.97	2.87	1.58	7.77	1.89	1.94
20	1.84	1.87	1.63	1.90	2.18	1.67	1.66	2.63	1.63	2.09	1.90	2.01
21	1.90	1.92	1.61	1.89	2.14	1.65	1.93	2.58	1.59	1.94	1.80	2.07
22	1.93	1.79	1.84	1.80	2.38	1.53	1.63	2.51	1.50	1.89	1.68	2.27
23	1.89	1.82	1.95	1.70	1.87	1.82	1.92	2.37	1.44	2.16	2.11	2.43
24	1.80	1.82	1.99	1.79	1.40	1.97	1.94	2.49	1.40	2.29	2.02	2.14
25	1.73	1.78	2.04	1.81	1.37	1.88	1.99	2.57	1.85	2.68	1.43	1.87
26	1.71	1.73	1.99	1.83	1.52	1.59	1.93	2.63	2.10	3.07	1.82	1.94
27	1.91	1.66	1.98	1.55	1.75	1.64	1.95	2.62	1.82	3.33	2.06	1.95
28	1.78	1.66	1.96	1.95	1.86	2.10	1.64	2.75	1.74	3.35	1.88	2.14
29	1.90	1.73	1.92	1.96	-----	1.16	1.57	2.80	1.75	3.53	1.83	2.26
30	1.69	1.84	1.91	1.60	-----	1.04	1.65	2.36	1.84	3.66	1.81	2.01
31	1.80	-----	1.82	1.76	-----	1.12	-----	1.91	-----	3.14	1.84	-----
Total	48.80	53.27	58.88	54.60	54.42	49.75	51.70	79.36	51.99	76.62	58.72	67.58
Mean	1.57	1.78	1.90	1.76	1.94	1.60	1.72	2.56	1.73	2.47	1.89	2.25
Max	2.29	3.26	3.66	2.05	2.38	2.10	1.99	5.84	2.10	7.77	2.11	2.71
Min	1.02	1.32	1.61	1.55	1.37	1.04	1.37	1.75	1.40	1.80	1.43	1.87
Acre-Ft	97	106	117	108	108	99	103	157	103	152	116	134
wtr Year 2015	Total	705.69	Mean	1.93	Max	7.77	Min	1.02	Inst Max	96.7	Acre-Ft	1400
Cal Year 2014	Total	835.52	Mean	2.29	Max	18.1	Min	1.02	Inst Max	54.0	Acre-Ft	1660

RUNOFF – DAILY DISCHARGE

Los Angeles County Dept of Public works

USDAY V106 Output 03/16/2016

Summary Report

Site: F377B Bouquet Creek Above Bouquet Canyon Road
 USGS #:
 Beginning Date: 10/01/2014
 Ending Date: 09/30/2015

Daily Mean Discharge in Cubic feet/second water Year Oct 2014 to Sep 2015

Day	OCT	NOV	DEC	JAN	FEB	MAR	APR	MAY	JUN	JUL	AUG	SEP
1	0	4.64	0	0	0	9.69	0	0	0	0	0	0
2	0	0	34.9	0	0	6.41	0	0	0	0	0	0
3	0	0	3.08	0	0	0	0	0	0	0	0	0
4	0	0	0	0	0	0	0	0	0	0	0	0
5	0	0	0	0	0	0	0	0	0	0	0	0
6	0	0	0	0	0	0	0	0	0	0	0	0
7	0	0	0	0	0	0	0	0	0	0	0	0
8	0	0	0	0	0	0	0	0	0	0	0	0
9	0	0	0	0	0	0	0	0	0	0	0	.28
10	0	0	0	1.94	0	0	0	0	0	0	0	0
11	0	0	0	17.9	0	0	0	0	0	0	0	0
12	0	0	54.7	0	0	0	0	0	0	0	0	0
13	0	0	0	0	0	0	0	0	0	0	0	0
14	0	0	0	0	0	0	0	9.20	0	0	0	0
15	0	0	0	0	0	0	0	0	0	0	0	16.9
16	0	0	0	0	0	0	0	0	0	0	0	0
17	0	0	12.2	0	0	0	0	0	0	0	0	0
18	0	0	0	0	0	0	0	0	0	1.17	0	0
19	0	0	0	0	0	0	0	0	0	15.4	0	0
20	0	0	0	0	0	0	0	0	0	0	0	0
21	0	0	0	0	0	0	0	0	0	0	0	0
22	0	0	0	0	4.94	0	0	0	0	0	0	0
23	0	0	0	0	.61	0	0	0	0	0	0	0
24	0	0	0	0	0	0	0	0	0	0	0	0
25	0	0	0	0	0	0	0	0	0	0	0	0
26	0	0	0	0	0	0	0	0	0	0	0	0
27	0	0	0	0	0	0	0	0	0	0	0	0
28	0	0	0	0	0	0	0	0	0	0	0	0
29	0	0	0	0	-----	0	0	0	0	0	0	0
30	0	0	0	0	-----	0	0	0	0	0	0	0
31	4.19	-----	0	0	-----	0	-----	0	-----	0	0	-----
Total	4.19	4.64	104.88	19.84	5.55	16.10	0	9.20	0	16.57	0	17.18
Mean	.14	.15	3.38	.64	.20	.52	0	.30	0	.53	0	.57
Max	4.19	4.64	54.7	17.9	4.94	9.69	0	9.20	0	15.4	0	16.9
Min	0	0	0	0	0	0	0	0	0	0	0	0
Acre-Ft	8.3	9.2	208	39	11	32	0	18	0	33	0	34
Wtr Year 2015	Total	198.15	Mean	.54	Max	54.7	Min	0	Inst Max	1510	Acre-Ft	393
Cal Year 2014	Total	236.51	Mean	.65	Max	76.2	Min	0	Inst Max	1510	Acre-Ft	469

RUNOFF – DAILY DISCHARGE

Los Angeles County Dept of Public works

USDAY V106 Output 03/16/2016

Summary Report

Site: F329 Bradbury Channel Below Central Avenue
 USGS #:
 Beginning Date: 10/01/2014
 Ending Date: 09/30/2015

Daily Mean Discharge in Cubic feet/second water Year Oct 2014 to Sep 2015

Day	OCT	NOV	DEC	JAN	FEB	MAR	APR	MAY	JUN	JUL	AUG	SEP
1	.09	0	.11	0	0	.19	.07	.07	.07	.08	.13	.09
2	.09	0	12.7	0	.04	.96	.08	.07	.07	.08	.04	.07
3	.08	0	3.28	0	0	.01	.08	.07	.14	.08	.10	.09
4	.07	0	.28	0	0	.01	.09	.07	.07	.09	.07	.09
5	.06	0	.07	.01	0	0	.08	.07	.07	.08	.06	.06
6	.05	0	.07	.01	0	.05	.08	.08	.07	.08	.04	.07
7	.03	0	0	0	.07	.07	.95	.18	.07	.08	.01	.07
8	.02	0	0	0	0	.05	.07	.35	.07	.10	.06	.10
9	0	0	0	0	0	.06	.08	0	.08	.09	0	.09
10	0	0	0	.45	.03	.06	.07	.02	.07	.08	.05	.09
11	0	0	0	2.08	0	.07	.07	.05	.07	.09	.08	.11
12	0	0	16.9	.01	.02	.06	.06	.06	.07	.58	.04	.02
13	.01	.43	.03	0	0	.06	.05	.07	.08	.33	.08	.01
14	0	.05	0	0	.02	.05	.07	3.19	.08	.08	.08	.08
15	0	.02	0	.02	.02	.04	.07	.02	.09	.07	.07	10.5
16	0	.01	.37	0	0	.04	.07	.01	.08	.01	.03	.33
17	0	.02	4.47	0	.07	.03	.07	0	.08	0	.11	.10
18	.01	.03	0	0	.07	.03	.07	.05	.09	.76	.08	.10
19	0	.02	0	0	.07	.02	.07	.09	.09	8.54	.07	.07
20	0	.01	0	.02	.07	.02	.07	.04	.09	.08	.08	.07
21	0	.04	0	.01	.08	.01	.07	.04	.09	.08	.07	.10
22	0	.01	0	.01	3.43	.01	.07	.05	.09	.07	0	.10
23	0	.01	0	0	3.20	.04	.08	.07	.08	.07	0	.08
24	0	0	0	0	.05	.07	.07	.06	.37	.07	.08	.09
25	0	.01	0	0	.01	.07	.58	.07	.07	.05	.09	.08
26	0	0	0	.60	0	.07	.04	.08	.05	0	.07	.07
27	0	0	.01	.07	.05	.07	.06	.07	.08	0	.10	.09
28	0	.04	0	.01	.07	.07	.07	.07	.08	0	.08	.11
29	0	.02	0	0	-----	.07	.07	.48	.08	0	.07	.09
30	0	1.06	.54	0	-----	.07	.07	.09	.08	.13	.02	.08
31	0	-----	0	.04	-----	.07	-----	.07	-----	.04	.08	-----
Total	0.51	1.78	38.83	3.34	7.37	2.50	3.50	5.71	2.67	11.89	1.94	13.10
Mean	.016	.059	1.25	.11	.26	.081	.12	.18	.089	.38	.063	.44
Max	.09	1.06	16.9	2.08	3.43	.96	.95	3.19	.37	8.54	.13	10.5
Min	0	0	0	0	0	0	.04	0	.05	0	0	.01
Acre-Ft	1.0	3.5	77	6.6	15	5.0	6.9	11	5.3	24	3.8	26
wtr Year 2015	Total	93.14	Mean	.26	Max	16.9	Min	0	Inst Max	346	Acre-Ft	185
Cal Year 2014	Total	89.73	Mean	.25	Max	22.0	Min	0	Inst Max	273	Acre-Ft	178

RUNOFF – DAILY DISCHARGE

Los Angeles County Dept of Public works

USDAY V106 Output 03/16/2016

Summary Report

Site: F342 Branford Street Channel Below Sharp Avenue
 USGS #:
 Beginning Date: 10/01/2014
 Ending Date: 09/30/2015

Daily Mean Discharge in Cubic feet/second water Year Oct 2014 to Sep 2015

Day	OCT	NOV	DEC	JAN	FEB	MAR	APR	MAY	JUN	JUL	AUG	SEP
1	.40	5.07	.74	.30	.13	13.9	.09	.05	.04	0	.05	.12
2	.40	.68	47.7	.33	.12	2.08	.06	.03	.07	0	0	.11
3	.40	.59	5.67	.32	.14	.10	.04	.05	.09	0	.01	.13
4	.39	.50	.55	.32	.09	.03	.04	.05	.12	0	.02	.40
5	.39	.48	.50	.31	.09	.02	.17	.05	.14	.01	.04	.15
6	.40	.46	.48	.31	.07	0	.05	.02	.16	0	.02	.16
7	.40	.45	.45	.31	.52	0	1.07	.09	.18	0	.04	.17
8	.41	.45	.45	.32	.16	.05	.12	.10	.20	0	.03	.19
9	.42	.45	.45	.33	.11	.02	.06	.05	.22	.76	0	.19
10	.42	.45	.45	9.64	.10	.04	.05	.12	.25	.02	.02	.21
11	.41	.45	.66	16.0	.10	.08	.05	.10	.27	0	.01	.22
12	.41	.45	74.7	.45	.09	.03	.06	.05	.29	0	0	.24
13	.39	.45	.46	.66	.09	.01	.06	.05	.31	0	.01	.27
14	.40	.45	.40	.38	.10	0	.07	6.55	.33	0	0	.27
15	.38	.45	.37	.36	.10	.01	.04	.17	.34	.01	.01	16.8
16	.37	.44	2.66	.36	.11	.02	.05	.11	.31	0	0	.22
17	.37	.43	16.5	.34	.15	.04	.04	.07	.28	0	.02	.11
18	.38	.44	.41	.36	.13	.06	.04	.06	.25	5.61	.05	.08
19	.40	.42	.39	.35	.12	.11	.05	.03	.21	2.13	0	.06
20	.39	.40	.36	.37	.12	.06	.05	.03	.18	.06	.03	.05
21	.38	.41	.35	.36	.11	.06	.07	.03	.15	.01	.09	.06
22	.38	.40	.35	.35	8.17	.07	.06	.04	.11	0	.06	.07
23	.39	.40	.35	.33	4.83	.07	.09	.03	.08	.01	.03	.17
24	.39	.38	.35	.32	.22	.06	.08	0	.05	0	.02	.11
25	1.44	.38	.34	.45	.06	.06	.59	0	.05	.42	.18	.08
26	.44	.38	.32	.92	.05	.04	.10	0	.05	0	1.15	.07
27	.45	.37	.30	.59	.06	.03	.05	0	.04	0	.10	.08
28	.45	.39	.33	.38	1.22	.05	.05	0	.04	0	.10	.08
29	.45	.40	.30	.36	-----	.06	.07	0	.04	0	.10	.09
30	.45	16.6	.30	9.48	-----	.08	.05	0	.04	0	.10	.08
31	6.64	-----	.30	.19	-----	.11	-----	0	-----	.01	.11	-----
Total	19.79	34.07	157.94	45.85	17.36	17.35	3.47	7.93	4.89	9.05	2.40	21.04
Mean	.64	1.14	5.09	1.48	.62	.56	.12	.26	.16	.29	.077	.70
Max	6.64	16.6	74.7	16.0	8.17	13.9	1.07	6.55	.34	5.61	1.15	16.8
Min	.37	.37	.30	.19	.05	0	.04	0	.04	0	0	.05
Acre-Ft	39	68	313	91	34	34	6.9	16	9.7	18	4.8	42
wtr Year 2015	Total	341.14	Mean	.93	Max	74.7	Min	0	Inst Max	554	Acre-Ft	677
Cal Year 2014	Total	525.26	Mean	1.44	Max	146	Min	.02	Inst Max	1010	Acre-Ft	1040

RUNOFF – DAILY DISCHARGE

Los Angeles County Dept of Public works

USDAY V106 Output 03/16/2016

Summary Report

Site: E285 Burbank-Western Storm Drain
 USGS #:
 Beginning Date: 10/01/2014
 Ending Date: 09/30/2015

Daily Mean Discharge in Cubic feet/second water Year Oct 2014 to Sep 2015

Day	OCT	NOV	DEC	JAN	FEB	MAR	APR	MAY	JUN	JUL	AUG	SEP
1	7.90	107	47.2	6.71	42.6	84.0	7.07	7.71	10.2	7.07	7.51	7.91
2	7.90	39.3	75.7	6.52	27.4	58.8	7.31	7.52	10.1	7.05	7.11	8.03
3	7.90	19.0	26.9	6.69	17.9	18.3	7.54	7.10	9.92	6.98	7.11	8.17
4	7.90	17.6	14.0	7.08	11.6	11.4	7.20	7.43	9.75	6.92	7.26	8.31
5	7.90	21.3	8.20	7.46	9.33	8.29	7.20	7.50	9.58	6.85	7.90	8.11
6	7.90	14.9	6.19	7.30	8.63	6.95	6.99	7.11	8.71	6.76	7.90	7.72
7	7.90	6.46	5.95	5.63	9.22	6.17	7.34	7.11	8.08	6.72	7.90	7.69
8	7.90	5.54	6.49	3.63	10.4	5.94	8.71	7.11	7.94	6.65	7.90	7.79
9	7.90	5.32	7.40	1.16	11.4	6.43	9.52	7.11	8.00	6.67	7.90	7.86
10	7.90	4.90	8.57	5.51	12.2	7.09	9.08	6.54	8.11	6.94	8.26	7.58
11	7.90	5.30	10.6	56.8	12.1	7.80	9.05	6.32	8.23	6.84	8.29	7.22
12	7.90	5.31	233	24.7	11.0	7.61	7.95	6.32	8.34	6.88	8.21	6.85
13	7.90	5.48	53.5	10.7	9.55	6.56	7.90	6.32	8.45	7.10	8.18	6.49
14	7.30	5.76	23.6	4.61	8.56	6.21	7.58	11.2	8.57	6.94	7.97	6.12
15	6.13	6.04	10.1	1.92	7.40	5.90	7.20	30.9	8.69	6.77	8.27	180
16	5.60	6.20	44.3	2.17	6.45	5.59	6.90	23.0	8.17	6.69	8.07	79.3
17	5.65	6.82	57.8	2.61	5.85	5.31	6.80	18.1	7.81	6.78	8.26	48.5
18	5.71	6.84	14.7	3.05	5.35	5.76	6.83	15.4	7.91	8.60	8.74	31.5
19	5.77	7.28	7.02	3.49	3.86	6.08	7.23	13.0	8.13	10.9	8.47	21.6
20	5.83	7.02	4.59	3.93	2.66	5.93	7.55	12.8	8.40	10.0	8.44	15.6
21	5.98	11.5	3.34	4.37	1.71	5.62	6.88	11.7	7.97	9.32	8.78	12.4
22	5.95	11.5	3.34	4.81	20.9	5.40	6.50	11.5	7.82	9.12	9.05	10.5
23	6.01	11.5	3.57	5.24	76.1	5.80	6.20	11.5	7.62	9.37	8.59	9.56
24	6.07	11.5	4.51	5.68	35.7	5.68	6.24	11.5	7.26	9.71	9.02	8.51
25	6.13	11.5	5.52	6.12	19.2	5.86	6.96	11.5	6.79	9.78		8.15
26	6.59	11.7	6.41	6.56	10.9	6.14	7.95	11.0	6.33	10.4	8.23	8.24
27	7.04	12.0	8.27	7.00	5.95	6.43	7.56	11.3	6.36	10.1	7.97	7.59
28	6.47	11.5	10.4	7.44	9.46	6.68	7.54	11.3	6.54	9.63	7.90	7.47
29	6.32	11.5	13.5	7.83	-----	6.36	7.63	10.7	6.73	9.44	7.51	7.53
30	7.12	633.4	13.6	58.2	-----	6.86	7.42	10.4	6.85	9.05	7.25	7.31
31	20.9	-----	9.96	69.8	-----	6.84	-----	10.2	-----		7.63	-----
Total	229.27	470.97	748.23	354.72	413.38	343.79	223.83	338.20	243.36	242.03	241.58	569.61
Mean	7.40	15.7	24.1	11.4	14.8	11.1	7.46	10.9	8.11	8.07	8.05	19.0
Max	20.9	107	233	69.8	76.1	84.0	9.52	30.9	10.2	10.9	9.05	180
Min	5.60	4.90	3.34	1.16	1.71	5.31	6.20	6.32	6.33	6.65	7.11	6.12
Acre-Ft	455	934	1480	704	820	682	444	671	483	480	479	1130
wtr Year 2015	Total	4418.97	Mean	12.2	Max	233	Min	1.16	Inst Max	3610	Acre-Ft	8760
Cal Year 2014	Total	5028.50	Mean	13.8	Max	454	Min	3.34	Inst Max	3690	Acre-Ft	9970

RUNOFF – DAILY DISCHARGE

Los Angeles County Dept of Public works

USDAY V106 Output 03/16/2016

Summary Report

Site: F37B Compton Creek near Greenleaf Drive
 USGS #:
 Beginning Date: 10/01/2014
 Ending Date: 09/30/2015

Daily Mean Discharge in Cubic feet/second water Year Oct 2014 to Sep 2015

Day	OCT	NOV	DEC	JAN	FEB	MAR	APR	MAY	JUN	JUL	AUG	SEP
1	.03	29.7	3.05	0	0	69.9	0	0	0	0	0	0
2	.02	.72	122	0	0	139	0	0	0	0	0	.06
3	0	.13	49.7	0	0	1.87	0	0	0	0	0	0
4	0	0	3.10	0	0	.24	0	0	0	0	0	.02
5	.04	0	0	0	0	.07	0	0	0	0	0	0
6	.01	0	0	0	0	0	0	0	0	0	0	0
7	0	0	0	0	0	0	12.6	20.1	0	0	0	0
8	.19	0	0	0	0	0	2.01	54.4	0	0	0	0
9	.02	.61	0	0	0	0	.11	.29	0	0	.02	0
10	.04	0	0	25.6	0	0	.07	.05	0	.06	.03	0
11	0	0	0	77.2	0	0	.06	0	0	0	.01	.17
12	0	0	86.7	.04	0	0	0	0	0	0	.14	0
13	0	0	1.03	0	0	0	.72	0	0	0	.02	0
14	0	.09	0	0	0	0	0	29.8	0	0	0	0
15	0	.03	0	0	0	.03	0	3.81	0	0	0	299
16	.15	0	68.5	0	0	0	.04	0	0	0	.40	6.17
17	0	0	28.7	0	0	0	0	0	0	0	0	2.36
18	.24	0	.06	0	0	.02	0	0	0	31.1	0	1.11
19	0	0	0	0	0	0	.01	0	0	3.64	0	.90
20	0	.40	0	0	0	.40	0	0	0	.60	.01	.90
21	0	.88	0	0	0	.43	0	.07	0	0	0	.90
22	.64	0	0	0	17.8	0	0	0	0	.07	0	.80
23	1.57	.11	0	0	12.2	0	0	0	0	.07	0	.72
24	.01	0	0	0	0	0	.01	0	0	0	0	.72
25	0	0	0	0	0	0	.27	0	0	0	0	.72
26	0	.11	0	2.12	0	0	.99	0	0	0	0	.78
27	.01	0	0	1.98	0	0	.98	0	0	0	0	.90
28	0	0	0	0	0	.01	.13	0	0	0	.01	.90
29	0	0	0	0	-----	.34	0	0	0	0	0	.84
30	0	25.0	0	.27	-----	.03	0	0	0	0	0	.72
31	.04	-----	.32	.08	-----	0	-----	0	-----	0	0	-----
Total	3.01	57.78	363.16	107.29	30.0	212.34	18.00	108.52	0	35.54	0.64	318.69
Mean	.097	1.93	11.7	3.46	1.07	6.85	.60	3.50	0	1.15	.021	10.6
Max	1.57	29.7	122	77.2	17.8	139	12.6	54.4	0	31.1	.40	299
Min	0	0	0	0	0	0	0	0	0	0	0	0
Acre-Ft	6.0	115	720	213	60	421	36	215	0	70	1.3	632
wtr Year 2015	Total	1254.97	Mean	3.44	Max	299	Min	0	Inst Max	3300	Acre-Ft	2490
Cal Year 2014	Total	997.87	Mean	2.73	Max	166	Min	0	Inst Max	530	Acre-Ft	1980

RUNOFF – DAILY DISCHARGE

Los Angeles County Dept of Public works

USDAY V106 Output 03/16/2016

Summary Report

Site: F354 Coyote Creek Below Spring Street
 USGS #:
 Beginning Date: 10/01/2014
 Ending Date: 09/30/2015

Daily Mean Discharge in Cubic feet/second water Year Oct 2014 to Sep 2015

Day	OCT	NOV	DEC	JAN	FEB	MAR	APR	MAY	JUN	JUL	AUG	SEP
1	7.35	436	410	5.59	13.9	115	20.3	5.61	7.20	3.43	1.27	4.57
2	6.39	15.3	1020	5.82	15.6	401	26.9	5.42	7.34	3.19	2.36	4.07
3	5.56	14.1	867	5.55	17.7	35.9	20.9	6.60	6.84	4.31	1.06	3.58
4	6.22	10.6	243	5.82	12.7	19.8	18.4	4.57	5.66	2.99	1.01	3.65
5	9.67	8.81	12.8	8.29	8.22	20.2	15.8	7.48	6.00	2.97	.95	3.22
6	5.55	10.0	9.74	9.39	5.87	12.6	18.7	6.33	5.55	3.15	.85	3.44
7	5.92	7.67	7.16	9.76	6.24	7.23	137	18.4	4.98	2.92	1.73	3.96
8	6.72	10.5	7.17	8.92	7.64	8.62	91.4	308	5.23	4.97	6.65	3.68
9	8.41	11.1	9.38	8.20	10.4	13.6	17.4	7.73	5.07	7.17	9.07	3.33
10	13.2	7.40	9.60	89.3	10.6	14.9	14.5	3.48	5.05	2.86	7.22	3.36
11	9.86	9.90	5.42	703	14.2	17.1	11.9	3.52	5.41	2.90	12.4	3.31
12	9.38	13.1	1710	34.5	12.6	16.5	12.0	2.68	5.38	2.77	11.8	3.02
13	8.48	11.5	36.5	8.87	11.5	17.1	16.0	2.84	5.28	4.88	7.81	3.23
14	8.56	13.2	9.10	10.7	11.8	17.0	14.4	241	4.89	.48	3.60	3.23
15	7.02	8.11	6.47	7.40	14.5	16.5	14.6	318	4.46	.27	3.04	1130
16	8.77	9.76	28.9	6.10	15.7	21.1	10.1	11.1	4.76	.16	4.39	30.4
17	8.98	8.59	339	5.48	37.6	18.7	9.58	5.24	5.00	.22	3.48	4.47
18	7.71	7.92	11.8	5.78	66.7	20.9	6.54	4.00	3.83	33.9	3.57	4.09
19	8.16	7.18	6.93	7.89	72.0	19.2	5.61	2.45	3.72	7.97	3.50	4.04
20	9.17	8.41	5.56	10.8	80.5	17.7	9.04	4.09	3.58	.92	3.67	4.86
21	10.3	10.3	4.74	8.87	85.8	17.5	9.41	2.79	3.47	.69	3.93	5.33
22	8.12	9.41	4.75	7.29	186	18.8	8.15	3.21	3.12	.81	3.78	5.32
23	9.76	10.8	5.71	6.81	349	20.1	9.85	3.41	3.26	2.17	3.89	4.31
24	7.03	10.7	5.43	6.99	22.3	18.5	7.43	3.27	3.39	.60	3.46	4.60
25	7.19	7.36	5.70	5.99	15.3	23.2	11.2	3.72	4.04	1.52	3.81	6.69
26	6.04	7.12	5.36	94.4	17.4	20.4	9.05	5.12	3.36	1.63	3.90	21.1
27	7.83	6.57	5.49	71.4	15.9	21.9	8.27	9.24	3.50	.42	10.9	16.3
28	12.6	8.26	7.37	9.12	28.5	17.9	7.45	23.7	2.94	.43	7.42	7.85
29	15.8	11.8	7.51	8.31	-----	16.4	5.13	15.8	2.88	.51	4.01	4.51
30	19.3	406	7.53	9.79	-----	20.3	6.00	7.05	3.44	.68	3.57	4.44
31	17.5	-----	20.2	12.8	-----	15.9	-----	6.57	-----	.67	3.50	-----
Total	282.55	1117.47	4835.32	1198.93	1166.17	1041.55	573.01	1052.42	138.63	102.56	141.60	1307.96
Mean	9.11	37.2	156	38.7	41.6	33.6	19.1	33.9	4.62	3.31	4.57	43.6
Max	19.3	436	1710	703	349	401	137	318	7.34	33.9	12.4	1130
Min	5.55	6.57	4.74	5.48	5.87	7.23	5.13	2.45	2.88	.16	.85	3.02
Acre-Ft	560	2220	9590	2380	2310	2070	1140	2090	275	203	281	2590
wtr Year 2015	Total	12958.17	Mean	35.5	Max	1710	Min	.16	Inst Max	7940	Acre-Ft	25700
Cal Year 2014	Total	21148.29	Mean	57.9	Max	2230	Min	1.30	Inst Max	7910	Acre-Ft	41950

RUNOFF – DAILY DISCHARGE

Los Angeles County Dept of Public works

USDAY V106 Output 03/16/2016

Summary Report

Site: F274B Dalton Wash at Merced Avenue
 USGS #:
 Beginning Date: 10/01/2014
 Ending Date: 09/30/2015

Daily Mean Discharge in Cubic feet/second Water Year Oct 2014 to Sep 2015

Day	OCT	NOV	DEC	JAN	FEB	MAR	APR	MAY	JUN	JUL	AUG	SEP
1	1.08	64.2	4.62	1.17	1.80	27.0	225	1.46	.72	.33	.12	.07
2	1.21	1.68	224	1.17	50.5	58.7	221	1.46	.72	.27	.10	.04
3	1.31	1.32	79.0	1.17	92.9	5.98	221	1.46	.72	.22	.12	.05
4	1.67	1.37	9.30	1.17	94.8	77.5	220	1.46	.72	.17	.13	.05
5	1.60	1.01	.70	1.17	94.9	125	218	1.46	.72	.15	.09	.04
6	1.99	.79	1.25	1.50	97.3	188	221	2.20	.72	.18	.07	.02
7	1.62	.72	1.71	3.67	99.0	231	130	12.3	.72	.21		.03
8	.95	.66	1.33	40.0	96.2	231	140	32.4	.71	.12	.19	.05
9	.41	.63	1.22	70.8	96.0	232	227	1.80	.72	.12	.19	6.83
10	.49	.59	1.18	31.8	99.1	229	221	1.66	.71	.13	.05	1.31
11	.67	.56	1.09	70.0	104	160	222	1.56	.67	.12	.13	2.03
12	.60	.48	276	1.04	105	230	225	1.46	3.11	.09	.12	1.33
13	.69	.47	14.1	25.7	106	230	230	1.46	.77	.09	.05	.38
14	.67	.44	13.2	67.3	108	229	117	90.0	.72	.10	.07	.09
15	.52	.44	12.2	65.8	110	231	17.3	7.66	.72	.08	.06	201
16	.55	.44	10.3	66.5	113	224	11.2	1.80	.72	.07	.04	3.32
17	.59	.40	127	66.0	113	224	5.49	1.80	.72	.09	.09	.28
18	.58	.36	12.9	65.6	112	227	1.46	1.80	.72	24.4	.08	.11
19	.45	.36	6.32	65.5	112	226	1.46	1.80	.67	119	.05	.07
20	.49	.35	1.17	68.1	116	228	1.46	1.80	.64	5.32	.05	.05
21	.63	60.4	1.17	69.5	121	228	1.46	1.80	.60	7.58	.06	.06
22	.55	.73	1.17	70.1	171	228	1.46	1.80	.55	2.66	.07	.15
23	.47	.55	1.17	70.2	89.9	225	1.46	1.80	.55	.18	.07	.17
24	.41	.51	1.17	69.2	69.8	221	1.46	1.80	.55	.13	.07	.06
25	.39	4.13	1.17	46.8	108	221	23.0	1.80	.55	.14	.09	.05
26	.39	3.68	1.17	32.1	107	234	3.65	1.80	.55	.10	.07	.07
27	.51	6.58	1.17	2.34	109	230	1.46	1.80	.55	.11	.05	.06
28	.66	5.69	1.17	2.20	120	223	1.46	1.66	.55	.13	.04	.07
29	.58	1.33	1.17	2.20	-----	222	1.46	1.46	.48	.48	.04	.07
30	1.01	20.4	25.3	1.80	-----	228	1.46	1.46	.40	3.21	.03	.07
31	4.25	-----	3.84	1.80	-----	229	-----	1.09	-----	.13	.05	-----
Total	27.99	181.27	838.26	1083.40	2817.20	6103.18	2914.70	187.07	21.97	166.11	2.44	217.98
Mean	.90	6.04	27.0	34.9	101	197	97.2	6.03	.73	5.36	.081	7.27
Max	4.25	64.2	276	70.8	171	234	230	90.0	3.11	119	.19	201
Min	.39	.35	.70	1.04	1.80	5.98	1.46	1.09	.40	.07	.03	.02
Acre-Ft	56	360	1660	2150	5590	12110	5780	371	44	329	4.8	432
wtr Year 2015	Total	14561.57	Mean	40.0	Max	276	Min	.02	Inst Max	5120	Acre-Ft	28880
Cal Year 2014	Total	2015.94	Mean	5.52	Max	384	Min	.07	Inst Max	5120	Acre-Ft	4000

RUNOFF – DAILY DISCHARGE

Los Angeles County Dept of Public works

USDAY V106 Output 03/16/2016

Summary Report

Site: F271 Eaton Wash Below Eaton Wash Dam
 USGS #:
 Beginning Date: 10/01/2014
 Ending Date: 09/30/2015

Daily Mean Discharge in Cubic feet/second water Year Oct 2014 to Sep 2015

Day	OCT	NOV	DEC	JAN	FEB	MAR	APR	MAY	JUN	JUL	AUG	SEP
1	0	.79	0	.12	0	.36	0	0	0	0	0	0
2	0	0	13.6	.11	0	.35	0	0	0	0	0	0
3	0	0	.49	.11	0	.39	0	0	0	0	0	0
4	0	0	.57	.11	0	.43	0	0	0	0	0	0
5	0	0	.36	17.1	0	.50	0	0	0	0	0	0
6	0	0	.30	2.44	0	.91	0	0	0	0	0	0
7	0	0	.13	.23	0	1.49	.25	0	0	0	0	0
8	0	0	0	.21	0	1.50	.08	.13	0	0	0	0
9	0	0	0	.18	0	.06	0	0	0	0	0	0
10	0	0	0	.75	0	0	0	0	0	0	0	0
11	0	0	0	.72	0	0	0	0	0	0	0	0
12	0	0	.27	.11	0	0	0	0	0	0	0	0
13	0	0	.09	.13	0	0	0	0	0	0	0	0
14	0	0	.10	.15	0	0	0	.88	0	0	0	0
15	0	0	.09	.10	0	0	0	.44	0	0	0	.47
16	0	0	.09	0	0	0	0	.21	0	0	0	.08
17	0	0	.09	0	0	0	0	.15	0	0	0	.06
18	0	0	.10	0	0	0	0	.08	0	0	0	.08
19	0	0	.10	0	0	0	0	.10	0	0	0	.11
20	0	0	.08	0	0	0	0	.13	0	0	0	.19
21	0	1.27	.07	0	0	0	0	.08	0	.12	0	.13
22	0	0	.08	0	.87	0	0	.04	0	.19	0	.07
23	0	0	.09	0	1.25	0	0	.07	0	.15	0	.07
24	0	0	.09	0	.38	0	0	.07	0	.48	0	.07
25	0	0	.11	0	.52	0	.11	.05	0	.58	0	.11
26	0	0	.18	0	.57	0	.04	.05	0	.50	0	.14
27	0	0	.20	0	.57	0	0	.02	0	1.66	0	.13
28	0	0	.20	0	.48	0	0	.20	0	.04	0	6.58
29	0	0	.19	0	-----	0	0	0	0	0	0	.08
30	0	.01	.20	0	-----	0	0	0	0	0	0	.09
31	.18	-----	.13	0	-----	0	-----	0	-----	0	0	-----
Total	0.18	2.07	18.00	22.57	4.64	5.99	0.48	2.70	0	3.72	0	8.46
Mean	.006	.069	.58	.73	.17	.19	.016	.087	0	.12	0	.28
Max	.18	1.27	13.6	17.1	1.25	1.50	.25	.88	0	1.66	0	6.58
Min	0	0	0	0	0	0	0	0	0	0	0	0
Acre-Ft	.36	4.1	36	45	9.2	12	.95	5.4	0	7.4	0	17
Wtr Year 2015	Total	68.81	Mean	.19	Max	17.1	Min	0	Inst Max	86.6	Acre-Ft	136
Cal Year 2014	Total	62.71	Mean	.17	Max	20.8	Min	0	Inst Max	97.3	Acre-Ft	124

RUNOFF – DAILY DISCHARGE

Los Angeles County Dept of Public works

USDAY V106 Output 03/16/2016

Summary Report

Site: F318 Eaton Wash at Loftus Drive
 USGS #:
 Beginning Date: 10/01/2014
 Ending Date: 09/30/2015

Daily Mean Discharge in Cubic feet/second Water Year Oct 2014 to Sep 2015

Day	OCT	NOV	DEC	JAN	FEB	MAR	APR	MAY	JUN	JUL	AUG	SEP
1	.53	51.2	1.17	.36	.12	.85	.23	.27	.12	.12	.12	.12
2	.51	.45	169	.36	.12	32.0	.12	.13	.13	.22	.12	.27
3	.52	.45	57.2	.36	.16	.56	.21	.13	.23	.12	.13	.12
4	.50	.44	2.88	.36	.15	.51	.12	.12	.24	.12	.22	.21
5	.49	.42	.42	.37	.13	.57	.12	.12	.29	.12	.13	.13
6	.51	.44	.37	.38	.12	.37	.12	.18	.15	.12	.13	.12
7	.48	.43	.37	.36	.31	.12	14.4	.29	.16	.14	.20	.12
8	.48	.44	.37	.41	.13	.12	.30	4.66	.15	.25	.13	.13
9	.46	.45	.38	.28	.12	.12	.13	.12	.16	.12	.12	.23
10	.49	.45	.39	11.6	.17	.23	.22	.12	.26	.22	.12	.12
11	.51	.43	.41	30.6	.20	.15	.12	.12	.16	.12	.12	.20
12	.51	.44	220	.20	.15	.12	.12	.12	.29	.13	.20	.13
13	.52	.43	.59	.13	.14	.21	.12	.22	.16	.13	.13	.12
14	.51	.43	.46	.21	.12	.12	.12	85.1	.14	.13	.21	.12
15	.49	.44	.46	.13	.12	.12	.19	.69	.16	.22	.13	213
16	.50	.44	4.92	.13	.17	.13	.12	.12	.17	.13	.12	.47
17	.49	.44	48.8	.13	.12	.12	.24	.12	.22	.23	.12	.12
18	.48	.43	.37	.13	.14	.57	.13	.12	.13	3.76	.13	.28
19	.48	.42	.36	.13	.13	.46	.12	.12	.28	6.48	.20	.13
20	.48	.42	.38	.14	.37	.20	.12	.23	.13	.25	.13	.12
21	.49	.42	.43	.12	.57	.12	.22	.12	.13	.14	.19	.13
22	.50	.42	.37	.13	57.6	.12	.13	.21	.13	.25	.13	.15
23	.58	.48	.38	.13	27.7	.13	.21	.12	.13	.16	.13	.19
24	.45	.49	.37	.12	.58	.12	.12	.12	.21	.21	.13	.12
25	.50	.49	.37	.12	.56	.24	13.8	.12	.13	.12	.13	.18
26	.50	.50	.37	3.78	.55	.12	.12	.14	.24	.12	.20	.14
27	.51	.54	.37	.24	.57	.21	.12	.22	.12	.14	.12	.12
28	.50	.48	.37	.12	1.18	.12	.13	.12	.12	.12	.20	.12
29	.50	.48	.37	.12	-----	.12	.23	.23	.13	.20	.13	.12
30	.49	17.6	12.4	.17	-----	.12	.12	.12	.32	.30	.12	.18
31	7.08	-----	.42	.38	-----	.12	-----	.12	-----	.24	.13	-----
Total	22.04	81.39	525.52	52.20	92.50	39.19	32.57	94.74	5.39	15.13	4.52	217.71
Mean	.71	2.71	17.0	1.68	3.30	1.26	1.09	3.06	.18	.49	.15	7.26
Max	7.08	51.2	220	30.6	57.6	32.0	14.4	85.1	.32	6.48	.22	213
Min	.45	.42	.36	.12	.12	.12	.12	.12	.12	.12	.12	.12
Acre-Ft	44	161	1040	104	183	78	65	188	11	30	9.0	432
wtr Year 2015	Total	1182.90	Mean	3.24	Max	220	Min	.12	Inst Max	2910	Acre-Ft	2350
Cal Year 2014	Total	1309.12	Mean	3.59	Max	318	Min	.36	Inst Max	2910	Acre-Ft	2600

RUNOFF – DAILY DISCHARGE

Los Angeles County Dept of Public works

USDAY V106 Output 03/16/2016

Summary Report

Site: U7 Fish Creek
 USGS #:
 Beginning Date: 10/01/2014
 Ending Date: 09/30/2015

Daily Mean Discharge in Cubic feet/second Water Year Oct 2014 to Sep 2015

Day	OCT	NOV	DEC	JAN	FEB	MAR	APR	MAY	JUN	JUL	AUG	SEP
1	1.03*	1.05*	1.05*	1.05*	1.05*	1.05*	1.05*	1.05*	1.05*	1.05*	1.05*	1.05*
2	.98*	1.05*	13.5*	1.05*	1.05*	1.05*	1.05*	1.05*	1.05*	1.05*	1.05*	1.05*
3	.94*	1.05*	6.77*	1.05*	1.05*	1.05*	1.05*	1.05*	1.05*	1.05*	1.05*	1.05*
4	.89*	1.05*	1.05*	1.05*	1.05*	1.05*	1.05*	1.05*	1.05*	1.05*	1.05*	1.05*
5	.85*	1.05*	1.05*	1.05*	1.05*	1.05*	1.05*	1.05*	1.05*	1.05*	1.05*	1.05*
6	.81*	1.05*	1.05*	1.05*	1.05*	1.05*	1.05*	1.05*	1.05*	1.05*	1.05*	1.05*
7	.77*	1.05*	1.05*	1.05*	1.05*	1.05*	1.05*	1.05*	1.05*	1.05*	1.05*	1.05*
8	.73*	1.05*	1.05*	1.05*	1.05*	1.05*	1.05*	1.05*	1.05*	1.05*	1.05*	1.05*
9	.69*	1.05*	1.05*	1.05*	1.05*	1.05*	1.05*	1.05*	1.05*	1.05*	1.05*	1.05*
10	.65*	1.05*	1.05*	1.05*	1.05*	1.05*	1.05*	1.05*	1.05*	1.05*	1.05*	1.05*
11	.62*	1.05*	1.05*	5.97*	1.05*	1.05*	1.05*	1.05*	1.05*	1.05*	1.05*	1.05*
12	.59*	1.05*	19.7*	1.05*	1.05*	1.05*	1.05*	1.05*	1.05*	1.05*	1.05*	1.05*
13	.55*	1.05*	1.05*	1.05*	1.05*	1.05*	1.05*	1.05*	1.05*	1.05*	1.05*	1.05*
14	.52*	1.05*	1.05*	1.05*	1.05*	1.05*	1.05*	6.97*	1.05*	1.05*	1.05*	1.05*
15	.50*	1.05*	1.05*	1.05*	1.05*	1.05*	1.05*	1.05*	1.05*	1.05*	1.05*	17.3*
16	.50*	1.05*	1.05*	1.05*	1.05*	1.05*	1.05*	1.05*	1.05*	1.05*	1.05*	1.05*
17	.50*	1.05*	8.25*	1.05*	1.05*	1.05*	1.05*	1.05*	1.05*	1.05*	1.05*	1.05*
18	.50*	1.05*	1.05*	1.05*	1.05*	1.05*	1.05*	1.05*	1.05*	1.05*	1.05*	1.05*
19	.50*	1.05*	1.05*	1.05*	1.05*	1.05*	1.05*	1.05*	1.05*	16.0*	1.05*	1.05*
20	.50*	1.05*	1.05*	1.05*	1.05*	1.05*	1.05*	1.05*	1.05*	1.05*	1.05*	1.05*
21	.50*	1.05*	1.05*	1.05*	1.05*	1.05*	1.05*	1.05*	1.05*	1.05*	1.05*	1.05*
22	.50*	1.05*	1.05*	1.05*	6.97*	1.05*	1.05*	1.05*	1.05*	1.05*	1.05*	1.05*
23	.50*	1.05*	1.05*	1.05*	6.97*	1.05*	1.05*	1.05*	1.05*	1.05*	1.05*	1.05*
24	.50*	1.05*	1.05*	1.05*	1.05*	1.05*	1.05*	1.05*	1.05*	1.05*	1.05*	1.05*
25	.50*	1.05*	1.05*	1.05*	1.05*	1.05*	1.05*	1.05*	1.05*	1.05*	1.05*	1.05*
26	.50*	1.05*	1.05*	1.05*	1.05*	1.05*	1.05*	1.05*	1.05*	1.05*	1.05*	1.05*
27	.50*	1.05*	1.05*	1.05*	1.05*	1.05*	1.05*	1.05*	1.05*	1.05*	1.05*	1.05*
28	.50*	1.05*	1.05*	1.05*	1.05*	1.05*	1.05*	1.05*	1.05*	1.05*	1.05*	1.05*
29	.50*	1.05*	1.05*	1.05*	-----	1.05*	1.05*	1.05*	1.05*	1.05*	1.05*	1.05*
30	.50*	2.99*	1.05*	1.05*	-----	1.05*	1.05*	1.05*	1.05*	1.05*	1.05*	1.05*
31	.50*	-----	1.05*	1.05*	-----	1.05*	-----	1.05*	-----	1.05*	-----	-----
Total	19.12	33.44	76.57	37.47	41.24	32.55	31.50	38.47	31.50	47.50	32.55	47.75
Mean	.62	1.11	2.47	1.21	1.47	1.05	1.05	1.24	1.05	1.53	1.05	1.59
Max	1.03	2.99	19.7	5.97	6.97	1.05	1.05	6.97	1.05	16.0	1.05	17.3
Min	.50	1.05	1.05	1.05	1.05	1.05	1.05	1.05	1.05	1.05	1.05	1.05
Acre-Ft	38	66	152	74	82	65	62	76	62	94	65	95
wtr Year 2015	Total	469.66	Mean	1.29	Max	19.7	Min	.50	Inst Max	19.7	Acre-Ft	932
Cal Year 2014	Total	642.76	Mean	1.76	Max	25.1	Min	.50	Inst Max	25.1	Acre-Ft	1270

* Indicates estimated flow.

RUNOFF – DAILY DISCHARGE

Los Angeles County Dept of Public works

USDAY V106 Output 03/16/2016

Summary Report

Site: L1 Little Rock Creek Above Little Rock Dam
 USGS #:
 Beginning Date: 10/01/2014
 Ending Date: 09/30/2015

Daily Mean Discharge in Cubic feet/second water Year Oct 2014 to Sep 2015

Day	OCT	NOV	DEC	JAN	FEB	MAR	APR	MAY	JUN	JUL	AUG	SEP
1	0	0	0	2.70	5.09	1.87	2.00	1.63	1.55	0	0	0
2	0	0	0	2.10	4.00	2.20	1.80	1.56	1.46	0	0	0
3	0	0	0	2.98	5.81	2.53	1.62	1.48	1.37	0	0	0
4	0	0	0	2.82	5.06	2.51	1.78	1.41	1.28	0	0	0
5	0	0	0	3.29	5.00	2.64	2.02	1.38	1.18	0	0	0
6	0	0	0	3.89	4.06	3.20	2.00	1.33	1.11	0	0	0
7	0	0	.57	4.65	4.02	4.59	1.51	1.29	1.03	0	0	0
8	0	0	1.32	4.87	3.74	5.27	1.73	.96	.94	0	0	0
9	0	0	1.53	7.68	3.47	4.63	2.08	1.15	.90	0	0	0
10	0	0	1.67	5.12	2.22	4.09	2.65	1.29	.82	0	0	0
11	0	0	2.33	5.75	2.34	4.84	2.60	1.23	.76	0	0	0
12	0	0	8.30	23.4	3.01	3.23	2.50	1.19	.71	0	0	0
13	0	0	10.4	18.6	2.44	4.18	2.39	1.15	.65	0	0	0
14	0	0	5.12	13.3	2.56	3.65	2.26	1.16	.57	0	0	0
15	0	0	5.45	8.93	3.01	3.32	1.89	.93	.49	0	0	0
16	0	0	1.04	9.67	2.73	2.94	2.02	1.79	.39	0	0	0
17	0	0	10.2	8.70	2.68	2.60	1.89	3.79	.27	0	0	0
18	0	0	6.98	10.2	2.46	2.59	1.85	3.93	.14	0	0	0
19	0	0	8.32	10.3	2.82	3.18	1.77	3.78	.01	0	0	0
20	0	0	9.01	9.21	2.87	3.04	1.71	3.65	0	0	0	0
21	0	0	10.6	8.20	2.63	2.89	1.70	3.36	0	0	0	0
22	0	0	11.7	7.08	2.56	2.71	1.66	3.21	0	0	0	0
23	0	0	15.5	6.60	1.58	2.32	1.69	3.18	0	0	0	0
24	0	0	13.9	9.28	2.77	2.26	1.84	3.05	0	0	0	0
25	0	0	10.5	11.1	2.95	2.24	2.43	2.76	0	0	0	0
26	0	0	5.47	9.86	3.11	2.51	1.94	2.44	0	0	0	0
27	0	0	5.22	9.47	3.32	2.42	2.30	2.25	0	0	0	0
28	0	0	6.02	6.15	2.42	2.34	2.05	2.06	0	0	0	0
29	0	0	7.97	8.83	-----	2.25	1.87	1.93	0	0	0	0
30	0	0	3.98	8.96	-----	2.17	1.73	1.79	0	0	0	0
31	0	-----	2.65	6.48	-----	2.10	-----	1.66	-----	0	0	-----
Total	0	0	165.75	250.17	90.73	93.31	59.28	63.77	15.63	0	0	0
Mean	0	0	5.35	8.07	3.24	3.01	1.98	2.06	.52	0	0	0
Max	0	0	15.5	23.4	5.81	5.27	2.65	3.93	1.55	0	0	0
Min	0	0	0	2.10	1.58	1.87	1.51	.93	0	0	0	0
Acre-Ft	0	0	329	496	180	185	118	126	31	0	0	0
wtr Year 2015	Total	738.64	Mean	2.02	Max	23.4	Min	0	Inst Max	74.4	Acre-Ft	1470
Cal Year 2014	Total	510.62	Mean	1.40	Max	23.4	Min	0	Inst Max	214	Acre-Ft	1010

RUNOFF – DAILY DISCHARGE

Los Angeles County Dept of Public works

USDAY V106 Output 06/30/2016

Summary Report

Site: F356 Live Oak Creek Below Live Oak Dam
 USGS #:
 Beginning Date: 10/01/2014
 Ending Date: 09/30/2015

Daily Mean Discharge in Cubic feet/second water Year Oct 2014 to Sep 2015

Day	OCT	NOV	DEC	JAN	FEB	MAR	APR	MAY	JUN	JUL	AUG	SEP
-												
1	0	0	0	0	0	.13	0	0	0	0	0	0
2	0	0	0	0	0	.13	0	0	0	0	0	0
3	0	0	0	0	0	.13	0	0	0	0	0	0
4	0	0	0	0	0	.06	0	0	0	0	0	0
5	0	0	0	0	0	0	0	0	0	0	0	0
6	0	0	0	0	0	0	0	0	0	0	0	0
7	0	0	0	0	0	0	0	0	0	0	0	0
8	0	0	0	0	0	0	0	0	0	0	0	0
9	0	0	0	0	0	0	0	0	0	0	0	0
10	0	0	0	0	0	0	0	0	0	0	0	0
11	0	0	0	0	0	0	0	0	0	0	0	0
12	0	0	0	0	0	0	0	0	0	0	0	0
13	0	0	0	0	0	0	0	0	0	0	0	0
14	0	0	0	0	0	0	0	0	0	0	0	0
15	0	0	0	0	0	0	0	0	0	0	0	0
16	0	0	0	0	0	0	0	0	0	0	0	0
17	0	0	0	0	0	0	0	0	0	0	0	0
18	0	0	0	0	0	0	0	0	0	0	0	0
19	0	0	0	0	0	0	0	0	0	0	0	0
20	0	0	0	0	0	0	0	0	0	0	0	0
21	0	0	0	0	0	0	0	0	0	0	0	0
22	0	0	0	0	0	0	0	0	0	0	0	0
23	0	0	0	0	.64	0	0	0	0	0	0	0
24	0	0	0	0	.25	0	0	0	0	0	0	0
25	0	0	0	0	.13	0	0	0	0	0	0	0
26	0	0	0	0	.10	0	0	0	0	0	0	0
27	0	0	0	0	0	0	0	0	0	0	0	0
28	0	0	0	0	.06	0	0	0	0	0	0	0
29	0	0	0	0	-----	0	0	0	0	0	0	0
30	0	0	0	0	-----	0	0	0	0	0	0	0
31	0	-----	0	0	-----	0	-----	0	-----	0	0	-----
Total	0	0	0	0	1.18	0.45	0	0	0	0	0	0
Mean	0	0	0	0	.042	.015	0	0	0	0	0	0
Max	0	0	0	0	.64	.13	0	0	0	0	0	0
Min	0	0	0	0	0	0	0	0	0	0	0	0
Acre-Ft	0	0	0	0	2.3	.89	0	0	0	0	0	0
wtr Year 2015	Total	1.63	Mean	.004	Max	.64	Min	0	Inst Max	1.17	Acre-Ft	3.2
Cal Year 2014	Total	0.25	Mean	.001	Max	.20	Min	0	Inst Max	2.26	Acre-Ft	.50

RUNOFF – DAILY DISCHARGE

Los Angeles County Dept of Public works

USDAY V106 Output 03/16/2016

Summary Report

Site: F319 Los Angeles River Below Wardlow Road
 USGS #:
 Beginning Date: 10/01/2014
 Ending Date: 09/30/2015

Daily Mean Discharge in Cubic feet/second Water Year Oct 2014 to Sep 2015

Day	OCT	NOV	DEC	JAN	FEB	MAR	APR	MAY	JUN	JUL	AUG	SEP
1	114	1850	879	123	123	1210	122	127	113	109	126	117
2	114	121	5010	121	119	3020	120	125	112	109	126	117
3	114	120	2640	120	116	656	120	124	112	109	126	117
4	112	120	911	120	121	123	120	125	112	108	126	117
5	112	120	117	120	127	120	119	125	112	108	126	116
6	112	120	117	121	129	120	119	125	112	108	125	115
7	112	120	120	124	129	121	144	177	112	107	123	115
8	112	120	120	126	130	121	484	1180	112	106	123	115
9	111	118	120	126	127	124	188	120	112	106	123	115
10	111	117	120	282	127	123	172	124	112	106	123	115
11	109	117	120	3800	128	123	163	127	113	106	123	115
12	109	117	8230	201	128	122	143	128	113	107	121	115
13	109	117	340	129	128	121	137	128	113	107	120	115
14	108	116	120	127	129	121	136	1170	113	107	120	115
15	109	115	123	128	127	121	134	1270	112	107	120	6290
16	110	115	638	128	126	121	129	118	112	106	120	195
17	108	115	2450	127	127	120	124	122	112	106	120	122
18	108	115	131	126	127	122	124	121	112	817	120	128
19	108	115	119	126	127	124	126	120	113	1100	120	128
20	107	113	120	126	128	126	127	120	113	505	120	128
21	107	112	120	126	126	126	125	119	114	118	120	129
22	107	112	120	124	537	125	125	119	114	123	120	128
23	107	112	120	125	1810	124	124	119	112	126	120	128
24	107	112	120	125	313	124	123	118	112	124	120	128
25	107	111	120	125	120	123	131	118	112	124	120	128
26	106	110	120	144	120	123	222	116	111	125	120	128
27	106	110	120	430	125	123	125	115	111	125	120	128
28	106	110	117	125	126	123	124	115	111	125	119	128
29	106	110	117	122	-----	123	124	115	110	126	117	128
30	107	1370	166	306	-----	123	126	115	110	126	117	128
31	108	-----	169	335	-----	123	-----	115	-----	126	117	-----
Total	3383	6450	23954	8488	5800	8319	4400	7060	3364	5612	3761	9891
Mean	109	215	773	274	207	268	147	228	112	181	121	330
Max	114	1850	8230	3800	1810	3020	484	1270	114	1100	126	6290
Min	106	110	117	120	116	120	119	115	110	106	117	115
Acre-Ft	6710	12790	47510	16840	11500	16500	8730	14000	6670	11130	7460	19620
wtr Year 2015	Total	90482	Mean	248	Max	8230	Min	106	Inst Max	30000	Acre-Ft	179500
Cal Year 2014	Total	97290.4	Mean	267	Max	9750	Min	97.5	Inst Max	31200	Acre-Ft	193000

RUNOFF – DAILY DISCHARGE

Los Angeles County Dept of Public works

USDAY V106 Output 03/16/2016

Summary Report

Site: F300 Los Angeles River at Tujunga Avenue
 USGS #:
 Beginning Date: 10/01/2014
 Ending Date: 09/30/2015

Daily Mean Discharge in Cubic feet/second water Year Oct 2014 to Sep 2015

Day	OCT	NOV	DEC	JAN	FEB	MAR	APR	MAY	JUN	JUL	AUG	SEP
1	51.8	378	120	52.1	54.8	1000	57.4	49.1	64.9	58.7	64.9	62.1
2	51.8	51.7	2020	55.0	46.6	645	55.1	52.5	64.8	60.2	65.3	62.7
3	49.2	51.0	825	54.9	47.5	126	55.4	52.3	63.7	59.8	66.2	63.4
4	53.6	47.0	99.1	52.7	51.6	65.1	53.3	54.9	61.5	59.7	66.4	62.1
5	50.5	47.2	66.5	55.2	53.7	61.7	52.0	60.7	57.0	59.1	63.1	60.4
6	52.8	46.8	59.5	56.9	48.2	59.0	52.7	59.7	54.1	59.5	61.9	60.0
7	50.2	46.9	54.2	55.5	57.8	57.8	68.5	57.3	55.3	59.5	63.4	61.3
8	49.9	45.2	57.1	57.5	61.8	58.0	61.1	57.4	57.3	59.9	57.2	57.9
9	52.3	46.7	55.7	57.2	54.3	60.0	48.5	56.6	52.2	48.6	65.4	54.7
10	50.7	48.3	55.8	369	55.2	59.6	46.5	58.4	54.3	55.0	59.4	55.1
11	46.9	47.7	58.2	1010	50.4	59.1	47.3	62.1	53.4	52.4	57.0	54.9
12	50.9	49.6	3100	75.3	52.6	57.3	46.8	62.4	55.2	53.5	57.5	54.4
13	39.8	52.0	83.1	69.7	51.7	59.0	43.3	64.3	58.2	52.3	53.9	58.6
14	29.6	50.4	63.0	65.5	56.3	57.0	38.6	333	60.6	55.1	50.2	61.7
15	22.3	48.0	63.0	64.2	56.1	57.2	41.6	149	60.3	55.2	48.4	1400
16	32.4	47.1	215	60.2	54.9	60.5	46.6	62.3	60.9	53.9	50.1	83.5
17	42.5	46.3	558	59.3	57.1	62.3	48.8	66.4	63.3	55.2	50.5	74.2
18	43.1	48.6	67.9	60.5	58.9	59.4	48.0	70.1	61.0	740	53.2	77.4
19	42.3	48.4	60.2	61.1	61.3	60.6	53.7	64.2	61.7	297	57.1	70.1
20	44.1	49.7	56.3	59.7	61.8	58.1	50.4	58.0	60.5	157	51.5	68.8
21	47.2	49.8	55.5	62.5	62.6	56.8	47.2	58.5	59.9	63.7	53.4	68.2
22	49.6	49.2	58.1	58.5	262	56.0	47.6	56.8	60.4	66.5	53.7	65.4
23	49.2	50.1	57.5	60.4	245	57.4	48.6	57.6	60.2	66.1	57.2	69.8
24	48.5	50.7	55.3	54.4	63.4	57.4	52.0	59.6	59.7	62.9	59.6	68.8
25	48.2	50.4	54.3	57.6	56.0	56.1	54.4	50.8	59.5	60.5	59.5	65.4
26	50.7	51.8	54.4	98.7	56.2	56.6	53.4	39.5	59.6	62.4	59.5	65.4
27	48.7	50.0	52.8	202	58.4	55.0	52.6	35.4	59.1	63.2	58.4	67.3
28	47.9	51.1	53.2	60.9	54.7	55.9	54.9	32.4	58.9	64.5	56.4	66.4
29	45.6	50.5	57.9	60.5	-----	51.3	46.1	39.7	57.3	65.3	58.1	65.1
30	45.8	927	57.2	174	-----	55.6	48.4	61.9	57.7	64.7	61.3	67.4
31	71.8	-----	55.5	60.5	-----	59.0	-----	59.8	-----	65.0	63.1	-----
Total	1459.9	2677.2	8349.3	3401.5	1950.9	3399.8	1520.8	2102.7	1772.5	2856.4	1802.8	3272.5
Mean	47.1	89.2	269	110	69.7	110	50.7	67.8	59.1	92.1	58.2	109
Max	71.8	927	3100	1010	262	1000	68.5	333	64.9	740	66.4	1400
Min	22.3	45.2	52.8	52.1	46.6	51.3	38.6	32.4	52.2	48.6	48.4	54.4
Acre-Ft	2900	5310	16560	6750	3870	6740	3020	4170	3520	5670	3580	6490
wtr Year 2015	Total	34566.3	Mean	94.7	Max	3100	Min	22.3	Inst Max	11900	Acre-Ft	68560
Cal Year 2014	Total	35920.3	Mean	98.4	Max	5500	Min	22.3	Inst Max	17100	Acre-Ft	71250

RUNOFF – DAILY DISCHARGE

Los Angeles County Dept of Public works

USDAY V106 Output 03/16/2016

Summary Report

Site: F57C Los Angeles River Above Arroyo Seco
 USGS #:
 Beginning Date: 10/01/2014
 Ending Date: 09/30/2015

Daily Mean Discharge in Cubic feet/second water Year Oct 2014 to Sep 2015

Day	OCT	NOV	DEC	JAN	FEB	MAR	APR	MAY	JUN	JUL	AUG	SEP
1	86.2	970	167	101	110	1340	83.1	113	95.8	92.7	91.3	82.0
2	86.0	103	2490	100	110	1090	78.1	111	97.8	93.8	86.4	86.6
3	86.8	80.0	777	99.0	98.3	186	81.4	108	101	93.5	81.8	91.5
4	88.1	67.1	161	98.1	111	103	78.5	105	103	94.8	75.5	94.1
5	89.6	66.6	117	97.2	107	102	79.7	104	103	95.0	64.8	99.5
6	91.2	71.5	111	96.2	105	102	80.9	102	105	96.2	59.2	96.3
7	93.0	77.3	105	95.3	108	103	99.1	97.6	105	88.5	68.5	87.6
8	94.7	78.3	101	95.1	131	103	93.1	96.8	105	81.4	76.9	78.0
9	95.5	79.3	97.8	95.7	114	103	84.1	92.3	104	77.7	82.4	65.1
10	93.6	80.4	96.2	391	113	105	87.8	89.0	106	77.8	82.9	70.5
11	90.3	81.4	95.1	1730	114	105	92.1	86.6	105	76.3	84.1	91.6
12	87.3	82.5	3940	101	115	105	94.0	84.3	104	74.8	89.4	88.5
13	84.6	82.9	102	101	114	105	106	82.1	104	74.0	97.5	104
14	81.9	81.7	99.3	99.6	115	105	77.8	1170	103	72.4	86.3	118
15	79.3	79.4	101	105	115	106	77.8	611	102	71.9	79.7	5760
16	77.4	77.0	168	96.9	112	108	76.6	101	100	71.2	79.3	497
17	77.5	74.8	1060	94.8	115	109	81.7	104	100	74.8	79.3	365
18	78.8	72.5	106	92.3	115	103	89.8	109	101	2060	86.3	118
19	80.1	70.3	107	92.1	116	98.2	88.6	112	102	654	96.9	113
20	81.4	69.0	106	91.4	112	98.9	87.4	115	100	328	97.3	107
21	82.7	70.2	106	95.0	115	96.8	83.2	112	97.9	104	97.0	97.5
22	84.1	73.0	105	94.7	415	93.4	80.0	103	94.4	120	94.5	90.7
23	84.7	76.0	105	101	514	90.2	78.9	100	92.0	118	90.6	115
24	83.5	78.9	105	101	120	87.3	81.3	97.4	89.9	107	88.6	143
25	81.1	82.0	104	113	101	86.4	104	93.5	88.0	106	88.0	131
26	78.8	85.1	104	148	102	86.7	95.2	90.4	88.3	105	85.6	121
27	76.5	88.5	103	270	103	83.6	98.8	87.8	90.3	105	81.2	113
28	74.2	92.4	103	120	103	83.1	104	85.5	89.2	104	82.8	107
29	72.0	96.7	103	113	-----	82.5	111	86.6	89.6	105	77.3	102
30	69.9	1030	103	288	-----	82.9	117	90.8	91.0	104	71.6	96.1
31	69.2	-----	102	103	-----	81.1	-----	93.3	-----	97.5	81.1	-----
Total	2580.0	4217.8	11250.4	5419.4	3823.3	5334.1	2671.0	4634.0	2957.2	5624.3	2584.1	9329.6
Mean	83.2	141	363	175	137	172	89.0	149	98.6	181	83.4	311
Max	95.5	1030	3940	1730	514	1340	117	1170	106	2060	97.5	5760
Min	69.2	66.6	95.1	91.4	98.3	81.1	76.6	82.1	88.0	71.2	59.2	65.1
Acre-Ft	5120	8370	22310	10750	7580	10580	5300	9190	5870	11160	5130	18500
Wtr Year 2015	Total	60425.2	Mean	166	Max	5760	Min	59.2	Inst Max	30700	Acre-Ft	119900
Cal Year 2014	Total	59736.3	Mean	164	Max	6130	Min	66.6	Inst Max	12700	Acre-Ft	118500

RUNOFF – DAILY DISCHARGE

Los Angeles County Dept of Public works

USDAY V106 Output 03/16/2016

Summary Report

Site: F130 Malibu Creek Below Cold Creek
 USGS #:
 Beginning Date: 10/01/2014
 Ending Date: 09/30/2015

Daily Mean Discharge in Cubic feet/second water Year Oct 2014 to Sep 2015

Day	OCT	NOV	DEC	JAN	FEB	MAR	APR	MAY	JUN	JUL	AUG	SEP
1	2.07	3.15	10.9	12.1	16.1	32.5	6.34	2.45	2.06	1.92	3.69	3.04
2	2.06	2.77	101	8.03	13.7	138	6.96	2.34	1.99	1.83	3.95	2.89
3	2.09	2.55	111	7.91	11.3	33.0	6.30	2.41	1.97	1.83	4.22	2.82
4	2.12	2.50	27.5	11.6	11.1	19.5	4.72	2.39	1.97	1.84	4.38	2.75
5	2.13	2.48	13.4	7.06	11.2	15.1	5.95	2.49	1.99	1.82	2.62	2.68
6	2.13	2.41	13.3	7.87	9.68	12.9	4.88	2.57	2.02	1.80	1.37	2.62
7	2.14	2.33	9.56	6.68	11.9	9.82	6.87	2.47	1.88	1.78	1.60	2.48
8	2.15	2.22	11.3	6.94	15.4	10.1	4.28	2.51	1.90	1.75	1.92	2.24
9	2.16	2.16	8.09	6.34	16.1	8.94	3.60	2.58	1.92	1.73	2.26	2.12
10	2.17	2.05	8.86	10.6	12.6	8.30	3.22	2.39	2.00	1.72	2.51	2.08
11	2.18	1.97	10.8	204	12.7	9.18	4.15	2.30	1.97	1.70	4.96	1.99
12	2.18	1.97	554	39.0	10.7	10.1	6.46	2.14	1.97	1.68	7.52	1.91
13	2.19	2.03	73.8	22.2	10.1	9.60	3.00	2.06	1.89	1.66	7.09	1.72
14	2.18	2.00	25.6	15.9	10.3	9.01	2.65	2.88	2.04	1.72	6.75	1.64
15	2.21	2.08	21.3	13.5	9.47	9.09	2.53	5.03	2.04	1.84	6.46	7.12
16	2.22	5.26	22.3	11.7	9.36	9.42	2.49	2.72	1.92	1.49	6.13	1.88
17	2.23	1.30	60.5	11.9	9.46	9.45	2.40	2.41	1.94	1.98	5.86	1.49
18	2.24	1.26	24.7	12.1	9.62	9.81	2.35	2.17	2.02	9.88	5.62	1.68
19	2.25	1.42	20.7	12.2	10.9	12.1	2.43	2.14	2.28	14.4	5.43	1.75
20	2.26	2.28	17.8	13.9	9.24	11.8	2.48	2.14	2.37	5.95	5.31	1.75
21	2.27	3.27	15.0	11.2	12.0	11.0	2.62	2.14	2.39	4.21	5.23	1.77
22	2.27	3.39	9.30	12.9	14.8	10.6	2.87	2.20	2.27	3.28	4.94	1.80
23	2.28	4.26	15.2	13.6	18.7	12.4	2.88	2.32	2.22	2.91	4.64	1.86
24	2.34	2.71	12.3	13.3	22.7	8.51	2.77	2.32	2.18	2.90	4.45	1.92
25	2.30	1.54	13.4	13.5	16.8	7.36	2.84	2.31	2.05	2.83	4.38	1.90
26	2.31	1.51	13.2	12.8	14.0	7.52	2.80	2.32	2.11	2.78	4.23	1.95
27	2.21	2.64	8.28	18.9	12.9	7.00	2.64	2.32	2.04	2.73	3.95	1.97
28	2.12	2.69	10.7	18.3	13.7	7.20	2.48	2.39	2.02	2.77	3.72	2.01
29	2.15	3.11	12.9	16.1	-----	7.44	2.44	2.41	1.93	2.81	3.55	2.04
30	2.26	19.0	11.3	15.0	-----	7.37	2.45	2.14	2.01	3.02	3.38	2.07
31	2.27	-----	7.30	15.5	-----	5.99	-----	2.02	-----	3.31	3.21	-----
Total	68.14	90.31	1275.29	602.63	356.53	480.11	110.85	75.48	61.36	93.87	135.33	67.94
Mean	2.20	3.01	41.1	19.4	12.7	15.5	3.70	2.43	2.05	3.03	4.37	2.26
Max	2.34	19.0	554	204	22.7	138	6.96	5.03	2.39	14.4	7.52	7.12
Min	2.06	1.26	7.30	6.34	9.24	5.99	2.35	2.02	1.88	1.49	1.37	1.49
Acre-Ft	135	179	2530	1200	707	952	220	150	122	186	268	135
wtr Year 2015	Total	3417.84	Mean	9.36	Max	554	Min	1.26	Inst Max	2130	Acre-Ft	6780
Cal Year 2014	Total	3663.34	Mean	10.0	Max	646	Min	1.26	Inst Max	2130	Acre-Ft	7270

RUNOFF – DAILY DISCHARGE

Los Angeles County Dept of Public works

USDAY V106 Output 03/16/2016

Summary Report

Site: F395 Mescal Creek near Pinon Hills
 USGS #:
 Beginning Date: 10/01/2014
 Ending Date: 09/30/2015

Daily Mean Discharge in Cubic feet/second water Year Oct 2014 to Sep 2015

Day	OCT	NOV	DEC	JAN	FEB	MAR	APR	MAY	JUN	JUL	AUG	SEP
1	0	0	0	0	.21	.61	.20	.16	.11	0	.20	0
2	0	0	0	0	.19	.99	.21	.14	.09	0	0	0
3	0	0	0	0	.12	.76	.20	.16	.10	0	0	0
4	0	0	0	0	.10	.77	.21	.15	.08	0	0	0
5	0	0	0	0	.16	.52	.21	.13	.09	0	0	0
6	0	0	0	0	.22	.51	.21	.20	.09	0	0	0
7	0	0	0	0	.28	.51	.22	.23	.08	0	0	0
8	0	0	0	0	.35	.49	.24	.33	.07	0	0	0
9	0	0	0	0	.41	.57	.08	.33	.05	0	0	0
10	0	0	0	0	.70	.66	.03	.30	.02	0	0	0
11	0	0	0	1.12	.48	.66	.06	.31	.07	0	0	0
12	0	0	0	1.15	.46	.69	.02	.33	.52	0	0	0
13	0	0	0	1.07	.45	.65	0	.33	.19	0	0	0
14	0	0	0	1.00	.44	.64	0	.49	0	0	0	0
15	0	0	0	.94	.43	.59	.05	.52	0	0	0	0
16	0	0	0	.87	.42	.58	.04	.23	0	0	0	0
17	0	0	0	.81	.41	.71	.06	.12	0	0	0	0
18	0	0	0	.76	.56	.89	0	.13	0	0	0	0
19	0	0	0	.70	.78	.74	0	.14	0	3.83	0	0
20	0	0	0	.65	.84	.60	0	.25	0	3.84	0	0
21	0	0	0	.60	.87	.48	.10	.32	0	.11	0	0
22	0	0	0	.55	1.12	.50	.12	.32	0	0	0	0
23	0	0	0	.51	1.16	.54	.22	.27	0	0	0	0
24	0	0	0	.47	1.04	.52	.10	.18	0	0	0	0
25	0	0	0	.43	.91	.40	.12	.13	0	0	0	0
26	0	0	0	.39	.61	.32	.11	.22	0	0	0	0
27	0	0	0	.36	.49	.26	.12	.21	0	0	0	0
28	0	0	0	.33	.49	.23	.19	.18	0	0	0	0
29	0	0	0	.30	-----	.16	.14	.15	0	0	0	0
30	0	0	0	.26	-----	.20	.16	.14	0	5.05	0	0
31	0	-----	0	.23	-----	.20	-----	.10	-----	5.28	0	-----
Total	0	0	0	13.50	14.70	16.95	3.42	7.20	1.56	18.11	0.20	0
Mean	0	0	0	.44	.53	.55	.11	.23	.052	.58	.006	0
Max	0	0	0	1.15	1.16	.99	.24	.52	.52	5.28	.20	0
Min	0	0	0	0	.10	.16	0	.10	0	0	0	0
Acre-Ft	0	0	0	27	29	34	6.8	14	3.1	36	.40	0
wtr Year 2015	Total	75.64	Mean	.21	Max	5.28	Min	0	Inst Max	25.6	Acre-Ft	150
Cal Year 2014	Total	91.11	Mean	.25	Max	9.14	Min	0	Inst Max	36.8	Acre-Ft	181

RUNOFF – DAILY DISCHARGE

Los Angeles County Dept of Public works

USDAY V106 Output 03/16/2016

Summary Report

Site: F328B Mint Canyon Creek at Sierra Highway
 USGS #:
 Beginning Date: 10/01/2014
 Ending Date: 09/30/2015

Daily Mean Discharge in Cubic feet/second water Year Oct 2014 to Sep 2015

Day	OCT	NOV	DEC	JAN	FEB	MAR	APR	MAY	JUN	JUL	AUG	SEP
1	0	0	0	0	0	96.8	0	0	0	0	0	0
2	0	0	1.69	0	0	68.3	0	0	0	0	0	0
3	0	0	0	0	0	.04	0	0	0	0	0	0
4	0	0	0	0	0	0	0	0	0	0	0	0
5	0	0	0	0	0	0	0	0	0	0	0	0
6	0	0	0	0	0	0	0	0	0	0	0	0
7	0	0	0	0	0	0	0	0	0	0	0	0
8	0	0	0	0	0	0	0	0	0	0	0	0
9	0	0	0	0	0	0	0	0	0	0	0	0
10	0	0	0	0	0	0	0	0	0	0	0	0
11	0	0	0	19.0	0	0	0	0	0	0	0	0
12	0	0	13.5	.57	0	0	0	0	0	0	0	0
13	0	0	.35	.03	0	0	0	0	0	0	0	0
14	0	0	0	0	0	0	0	9.63	0	0	0	0
15	0	0	0	0	0	0	0	6.64	0	0	0	69.9
16	0	0	0	0	0	0	0	0	0	0	0	4.20
17	0	0	3.76	0	0	0	0	0	0	0	0	0
18	0	0	0	0	0	0	0	0	0	1.66	0	0
19	0	0	0	0	0	0	0	0	0	2.94	0	0
20	0	0	0	0	0	0	0	0	0	0	0	0
21	0	0	0	0	0	0	0	0	0	0	0	0
22	0	0	0	0	29.9	0	0	0	0	0	0	0
23	0	0	0	0	24.6	0	0	0	0	0	0	0
24	0	0	0	0	2.39	0	0	0	0	0	0	0
25	0	0	0	0	0	0	0	0	0	0	0	0
26	0	0	0	0	0	0	0	0	0	0	0	0
27	0	0	0	0	0	0	0	0	0	0	0	0
28	0	0	0	0	0	0	0	0	0	0	0	0
29	0	0	0	0	-----	0	0	0	0	0	0	0
30	0	0	0	0	-----	0	0	0	0	2.70	0	0
31	0	-----	0	0	-----	0	-----	0	-----	0	0	-----
Total	0	0	19.30	19.60	56.89	165.14	0	16.27	0	7.30	0	74.10
Mean	0	0	.62	.63	2.03	5.33	0	.52	0	.24	0	2.47
Max	0	0	13.5	19.0	29.9	96.8	0	9.63	0	2.94	0	69.9
Min	0	0	0	0	0	0	0	0	0	0	0	0
Acre-Ft	0	0	38	39	113	328	0	32	0	14	0	147
wtr Year 2015	Total	358.60	Mean	.98	Max	96.8	Min	0	Inst Max	352	Acre-Ft	711
Cal Year 2014	Total	29.95	Mean	.082	Max	13.5	Min	0	Inst Max	155	Acre-Ft	59

RUNOFF – DAILY DISCHARGE

Los Angeles County Dept of Public works

USDAY V106 Output 03/16/2016

Summary Report

Site: F181 Montebello Storm Drain Above Rio Hondo
 USGS #:
 Beginning Date: 10/01/2014
 Ending Date: 09/30/2015

Daily Mean Discharge in Cubic feet/second Water Year Oct 2014 to Sep 2015

Day	OCT	NOV	DEC	JAN	FEB	MAR	APR	MAY	JUN	JUL	AUG	SEP
1	.58	1.36	.77	.52	.39	.67	.26	.26	.51	.86	.43	.07
2	.54	.68	3.08	.52	.39	1.20	.26	.20	.52	.85	.42	.07
3	.52	.65	1.62	.40	.39	.52	.26	.13	.53	.82	.40	.07
4	.52	.65	.77	.39	.39	.52	.26	.13	.54	.69	.39	.07
5	.52	.65	.77	.39	.39	.52	.26	.13	.56	.68	.38	.07
6	.52	.54	.66	.39	.39	.43	.17	0	.57	.66	.37	.08
7	.52	.52	.65	.39	.31	.39	.28	.13	.58	.65	.36	.08
8	.52	.52	.65	.39	.26	.39	.52	1.33	.59	.64	.35	.08
9	.52	.52	.58	.39	.26	.39	.52	.52	.61	.62	.33	.08
10	.52	.52	.52	.76	.26	.39	.52	.49	.62	.61	.32	.08
11	.52	.42	.52	.75	.26	.39	.50	.39	.63	.59	.31	.09
12	.52	.39	3.78	.52	.26	.34	.39	.39	.64	.58	.30	.09
13	.42	.39	.52	.52	.26	.26	.39	.39	.65	.57	.29	.09
14	.39	.39	.52	.52	.26	.26	.39	1.31	.67	.55	.27	12.5
15	.39	.31	.52	.52	.19	.26	.39	.52	.68	.54	.26	12.5
16	.39	.26	.47	.43	.13	.26	.39	.52	.69	.45	.25	.10
17	.39	.26	1.02	.39	.13	.26	.39	.38	.70	.38	.24	.10
18	.39	.28	.52	.39	.13	.26	.38	.18	.72	.46	.23	.10
19	.39	.45	.52	.39	.13	.26	.26	.03	.73	.74	.21	.10
20	.39	.65	.52	.39	.13	.26	.26	0	.74	.73	.20	.11
21	.39	.75	.39	.39	.13	.18	.26	0	.75	.71	.19	.11
22	.39	.65	.39	.39	.81	.13	.26	.11	.77	.69	.18	.11
23	.39	.65	.39	.39	.55	.13	.23	.28	.78	.66	.17	.11
24	.29	.63	.39	.27	.52	.13	.13	.45	.79	.64	.15	.11
25	.26	.52	.39	.26	.43	.44	.25	.61	.80	.61	.14	.12
26	.26	.52	.30	.48	.39	.43	.52	.63	.81	.58	.13	.12
27	.26	.52	.26	.52	.39	.39	.39	.61	.83	.56	.12	.12
28	.26	.52	.26	.52	.39	.39	.39	.59	.84	.53	.11	.12
29	.26	.44	.26	.52	-----	.39	.34	.57	.85	.50	.09	.13
30	.28	.79	.50	.49	-----	.39	.26	.56	.86	.48	.08	.13
31	.37	-----	.52	.39	-----	.32	-----	.54	-----	.45	.07	-----
Total	12.88	16.40	23.03	13.98	8.92	11.55	10.08	12.38	20.56	19.08	7.74	27.71
Mean	.42	.55	.74	.45	.32	.37	.34	.40	.69	.62	.25	.92
Max	.58	1.36	3.78	.76	.81	1.20	.52	1.33	.86	.86	.43	12.5
Min	.26	.26	.26	.26	.13	.13	.13	0	.51	.38	.07	.07
Acre-Ft	26	33	46	28	18	23	20	25	41	38	15	55
wtr Year 2015	Total	184.31	Mean	.50	Max	12.5	Min	0	Inst Max	25.1	Acre-Ft	366
Cal Year 2014	Total	195.36	Mean	.54	Max	6.58	Min	0	Inst Max	28.5	Acre-Ft	387

RUNOFF – DAILY DISCHARGE

Los Angeles County Dept of Public works

USDAY V106 Output 03/16/2016

Summary Report

Site: F118C Pacoima Creek below Pacoima Dam
 USGS #:
 Beginning Date: 10/01/2014
 Ending Date: 09/30/2015

Daily Mean Discharge in Cubic feet/second water Year Oct 2014 to Sep 2015

Day	OCT	NOV	DEC	JAN	FEB	MAR	APR	MAY	JUN	JUL	AUG	SEP
1	0	0	0	0	0	0	0	0	0	0	0	0
2	0	0	0	0	0	0	0	0	0	0	0	0
3	0	0	0	0	0	0	0	0	0	0	0	0
4	0	0	0	0	0	0	0	0	0	0	0	0
5	0	0	0	0	0	0	0	0	0	0	0	0
6	0	0	0	0	0	0	0	0	0	0	0	0
7	0	0	0	0	0	0	0	0	0	0	0	0
8	0	0	0	0	0	0	0	0	0	0	0	0
9	0	0	0	0	0	0	0	0	0	0	0	0
10	0	0	0	0	0	0	0	0	0	0	0	0
11	0	0	0	0	0	0	0	0	0	0	0	0
12	0	0	0	0	0	0	0	0	0	0	0	0
13	0	0	0	0	0	0	0	0	0	0	0	0
14	0	0	0	0	0	0	0	0	0	0	0	0
15	0	0	0	0	0	0	0	0	0	0	0	.96
16	0	0	0	0	0	0	0	0	0	0	0	0
17	0	0	.66	0	0	0	0	0	0	0	0	0
18	0	0	0	0	0	0	0	0	0	0	0	0
19	0	0	0	0	0	0	0	0	0	0	0	0
20	0	0	0	0	0	0	0	0	0	0	0	0
21	0	0	0	0	0	0	0	0	0	0	0	0
22	0	0	0	0	1.13	0	0	0	0	0	0	0
23	8.97	0	0	0	0	0	0	0	0	0	0	0
24	0	0	0	0	0	0	0	0	0	0	0	0
25	0	0	0	0	0	0	0	0	0	0	0	0
26	0	0	0	0	0	0	0	0	0	0	0	0
27	0	0	0	0	0	0	0	0	0	0	0	0
28	0	0	0	0	0	0	2.88	0	0	0	0	0
29	0	0	0	0	-----	0	0	0	0	0	0	0
30	0	0	0	0	-----	0	0	0	0	0	0	0
31	1.19	-----	0	0	-----	0	-----	0	-----	0	0	-----
Total	10.16	0	0.66	0	1.13	0	2.88	0	0	0	0	0.96
Mean	.33	0	.021	0	.040	0	.096	0	0	0	0	.032
Max	8.97	0	.66	0	1.13	0	2.88	0	0	0	0	.96
Min	0	0	0	0	0	0	0	0	0	0	0	0
Acre-Ft	20	0	1.3	0	2.2	0	5.7	0	0	0	0	1.9
Wtr Year 2015	Total	15.79	Mean	.043	Max	8.97	Min	0	Inst Max	355	Acre-Ft	31
Cal Year 2014	Total	280.42	Mean	.77	Max	84.4	Min	0	Inst Max	275	Acre-Ft	556

RUNOFF – DAILY DISCHARGE

Los Angeles County Dept of Public works

USDAY V106 Output 03/16/2016

Summary Report

Site: F305 Pacoima Diversion at Branford Street
 USGS #:
 Beginning Date: 10/01/2014
 Ending Date: 09/30/2015

Daily Mean Discharge in Cubic feet/second Water Year Oct 2014 to Sep 2015

Day	OCT	NOV	DEC	JAN	FEB	MAR	APR	MAY	JUN	JUL	AUG	SEP
1	.23	18.7	2.58	.25	.34	49.2	.44	.11	.23	0	.17	.10
2	.20	.22	49.7	.38	.35	4.07	.39	.09	.18	0	.16	.10
3	.10	.15	35.9	.47	.34	.58	.75	.14	.31	0	.20	.12
4	.18	.08	.62	.47	.41	.31	.17	.27	.40	0	.14	.18
5	.15	.17	.41	.40	.37	.27	.13	.37	.31	0	.92	.13
6	.24	.28	.67	.48	.35	.27	.20	.38	.23	0	1.98	.09
7	.24	.37	.30	.51	.73	.13	2.85	.31	.16	0	.24	.09
8	.26	.30	.57	.61	.52	.58	.48	.71	.10	0	.21	.61
9	.31	.32	.25	.55	.55	.74	.21	.26	.25	0	.18	.34
10	.33	.41	.26	39.5	.50	.74	.29	.15	.43	.77	.19	.24
11	.30	.38	.73	10.9	.39	.76	.28	.13	.38	.22	.18	.29
12	.51	.33	160	.42	.40	.24	.26	.16	.36	.05	.15	.29
13	.33	.35	.59	.29	.88	.23	.25	.22	.38	.13	.08	.22
14	.31	.39	.34	.24	.72	.19	.23	17.7	.26	.07	.12	.14
15	.35	.36	.38	.24	.35	.27	.09	.62	.24	.15	.24	47.2
16	.38	.26	4.81	.30	.38	.27	.11	.26	.18	.01	.02	1.23
17	.33	.14	28.1	.26	.53	.28	.14	.23	.07	.57	.09	.19
18	.31	.27	.44	.34	.42	.43	.20	.53	.05	18.4	.17	.13
19	.27	.37	.33	.31	.41	.48	.32	.27	.02	5.12	.19	.16
20	.36	.34	.31	.35	.46	.35	.37	.17	.04	.60	.21	.31
21	.33	.39	.31	.39	.39	.38	.50	.22	.07	.32	.32	.36
22	.28	.31	.47	.32	17.5	.40	.56	.32	.05	.20	.27	1.22
23	.34	.27	.49	.50	7.52	.48	.57	.33	0	.26	.12	.38
24	.25	.24	.73	.39	.40	.19	.61	.26	0	.18	.10	.32
25	.27	.29	.27	.26	.32	.17	1.51	.29	0	.10	.30	.35
26	.22	.40	.12	1.40	.35	.24	.30	.32	0	.07	.30	.30
27	.29	.32	.09	1.10	.44	.24	.13	.31	0	.11	.34	.25
28	.39	.32	.22	.34	.69	.19	.11	.25	0	.13	.18	.32
29	.35	.36	.16	.45	-----	.18	.15	.24	0	.24	.12	.37
30	.28	34.3	.25	27.0	-----	.21	.10	.22	0	.15	.08	.33
31	24.8	-----	.07	.46	-----	.48	-----	.16	-----	.25	.20	-----
Total	33.49	61.39	290.47	89.88	37.01	63.55	12.70	26.00	4.70	28.10	8.17	56.36
Mean	1.08	2.05	9.37	2.90	1.32	2.05	.42	.84	.16	.91	.26	1.88
Max	24.8	34.3	160	39.5	17.5	49.2	2.85	17.7	.43	18.4	1.98	47.2
Min	.10	.08	.07	.24	.32	.13	.09	.09	0	0	.02	.09
Acre-Ft	66	122	576	178	73	126	25	52	9.3	56	16	112
wtr Year 2015	Total	711.82	Mean	1.95	Max	160	Min	0	Inst Max	1690	Acre-Ft	1410
Cal Year 2014	Total	927.66	Mean	2.54	Max	258	Min	.01	Inst Max	1690	Acre-Ft	1840

RUNOFF – DAILY DISCHARGE

Los Angeles County Dept of Public works

USDAY V106 Output 03/16/2016

Summary Report

Site: F122 Pallett Creek at Big Rock Creek Near Valyermo
 USGS #:
 Beginning Date: 10/01/2014
 Ending Date: 09/30/2015

Daily Mean Discharge in Cubic feet/second water Year Oct 2014 to Sep 2015

Day	OCT	NOV	DEC	JAN	FEB	MAR	APR	MAY	JUN	JUL	AUG	SEP
1	0	0	0	0	0	0	0	0	0	0	0	0
2	0	0	0	0	0	0	0	0	0	0	0	0
3	0	0	0	0	0	0	0	0	0	0	0	0
4	0	0	0	0	0	0	0	0	0	0	0	0
5	0	0	0	0	0	0	0	0	0	0	0	0
6	0	0	0	0	0	0	0	0	0	0	0	0
7	0	0	0	0	0	0	0	0	0	0	0	0
8	0	0	0	0	0	0	0	0	0	0	0	0
9	0	0	0	0	0	0	0	0	0	0	0	0
10	0	0	0	0	0	0	0	0	0	0	0	0
11	0	0	0	0	0	0	0	0	0	0	0	0
12	0	0	0	0	0	0	0	0	0	0	0	0
13	0	0	0	0	0	0	0	0	0	0	0	0
14	0	0	0	0	0	0	0	0	0	0	0	0
15	0	0	0	0	0	0	0	0	0	0	0	0
16	0	0	0	0	0	0	0	0	0	0	0	0
17	0	0	0	0	0	0	0	0	0	0	0	0
18	0	0	0	0	0	0	0	0	0	0	0	0
19	0	0	0	0	0	0	0	0	0	0	0	0
20	0	0	0	0	0	0	0	0	0	0	0	0
21	0	0	0	0	0	0	0	0	0	0	0	0
22	0	0	0	0	0	0	0	0	0	0	0	0
23	0	0	0	0	0	0	0	0	0	0	0	0
24	0	0	0	0	0	0	0	0	0	0	0	0
25	0	0	0	0	0	0	0	0	0	0	0	0
26	0	0	0	0	0	0	0	0	0	0	0	0
27	0	0	0	0	0	0	0	0	0	0	0	0
28	0	0	0	0	0	0	0	0	0	0	0	0
29	0	0	0	0	-----	0	0	0	0	0	0	0
30	0	0	0	0	-----	0	0	0	0	3.38	0	0
31	0	-----	0	0	-----	0	-----	0	-----	0	0	-----
Total	0	0	0	0	0	0	0	0	0	3.38	0	0
Mean	0	0	0	0	0	0	0	0	0	.11	0	0
Max	0	0	0	0	0	0	0	0	0	3.38	0	0
Min	0	0	0	0	0	0	0	0	0	0	0	0
Acre-Ft	0	0	0	0	0	0	0	0	0	6.7	0	0
wtr Year 2015	Total	3.38	Mean	.009	Max	3.38	Min	0	Inst Max	58.9	Acre-Ft	6.7
Cal Year 2014	Total	174.73	Mean	.48	Max	109	Min	0	Inst Max	337	Acre-Ft	347

RUNOFF – DAILY DISCHARGE

Los Angeles County Dept of Public works

USDAY V106 Output 03/16/2016

Summary Report

Site: F45B Rio Hondo Above Stewart and Gray Road
 USGS #:
 Beginning Date: 10/01/2014
 Ending Date: 09/30/2015

Daily Mean Discharge in Cubic feet/second water Year Oct 2014 to Sep 2015

Day	OCT	NOV	DEC	JAN	FEB	MAR	APR	MAY	JUN	JUL	AUG	SEP
1	.05	123	4.36	.03	.02	1.03	0	0	.04	.01	.01	0
2	.04	2.25	241	.02	.01	47.2	0	0	.04	.01	.01	0
3	.04	1.38	91.8	.02	.01	1.18	0	0	.03	0	.01	0
4	.03	.90	70.6	.01	.03	.05	0	0	.02	0	0	.01
5	.03	.93	.54	.01	.04	.04	0	0	.01	0	0	.02
6	.02	1.27	.06	0	.03	.04	.17	0	0	0	0	.02
7	.01	.76	.05	0	.02	.04	2.37	0	0	0	0	.02
8	0	.53	.05	0	.02	.04	.41	0	.17	0	0	.02
9	0	.36	.04	0	.02	.03	.05	0	.13	0	0	.02
10	0	.34	.04	0	.01	.03	.02	.01	.17	0	0	.02
11	0	.18	.03	0	.01	.03	0	.01	.07	0	0	.02
12	0	.10	171	0	0	.02	0	.02	.05	0	0	.02
13	0	.06	.07	0	0	.02	0	.02	.04	0	0	.01
14	0	.92	.05	0	0	.02	0	.03	.03	0	0	.01
15	0	.76	.04	0	0	.01	0	.03	.02	0	0	36.3
16	0	.55	.04	0	0	.01	0	.03	.01	0	0	5.67
17	0	.36	11.5	.01	0	0	0	.04	0	0	0	.04
18	0	.26	.05	.01	0	0	0	.04	0	.03	0	.04
19	0	.14	.04	.01	0	0	0	.04	0	.03	0	.03
20	0	.07	.04	.01	0	0	0	.04	0	.02	0	.03
21	.01	.05	.03	.01	0	0	0	.04	0	.02	0	.03
22	.01	.04	.02	.01	25.2	0	0	.04	0	.02	0	.03
23	.01	.03	.02	.01	40.3	0	0	.05	0	.02	0	.03
24	.01	.02	.01	.01	.43	0	0	.05	0	.02	0	.03
25	.01	.01	.01	.02	.04	0	0	.05	.01	.02	0	.03
26	.01	0	0	.02	.03	0	0	.05	.01	.02	0	.03
27	.01	0	0	.02	.02	0	0	.05	.01	.02	0	.03
28	.01	0	0	.02	.02	0	0	.05	.01	.02	0	.03
29	.01	.01	0	.02	-----	0	0	.05	.01	.02	0	.03
30	.01	75.1	.79	.02	-----	0	0	.05	.01	.01	0	.03
31	3.22	-----	.06	.02	-----	0	-----	.05	-----	.01	0	-----
Total	3.54	210.38	592.34	0.31	66.26	49.79	3.02	0.84	0.89	0.30	0.03	42.60
Mean	.11	7.01	19.1	.010	2.37	1.61	.10	.027	.030	.010	.001	1.42
Max	3.22	123	241	.03	40.3	47.2	2.37	.05	.17	.03	.01	36.3
Min	0	0	0	0	0	0	0	0	0	0	0	0
Acre-Ft	7.0	417	1170	.61	131	99	6.0	1.7	1.8	.60	.06	84
wtr Year 2015	Total	970.30	Mean	2.66	Max	241	Min	0	Inst Max	3030	Acre-Ft	1920
Cal Year 2014	Total	1398.71	Mean	3.83	Max	277	Min	0	Inst Max	3030	Acre-Ft	2770

RUNOFF – DAILY DISCHARGE

Los Angeles County Dept of Public works

USDAY V106 Output 03/16/2016

Summary Report

Site: F192B Rio Hondo Below Lower Azusa Road
 USGS #:
 Beginning Date: 10/01/2014
 Ending Date: 09/30/2015

Daily Mean Discharge in Cubic feet/second water Year Oct 2014 to Sep 2015

Day	OCT	NOV	DEC	JAN	FEB	MAR	APR	MAY	JUN	JUL	AUG	SEP
1	0	4.37	.32	0	0	.91	0	0	0	0	0	0
2	0	0	18.3	0	0	3.21	0	0	0	0	0	0
3	0	0	5.02	0	0	0	0	0	0	0	0	0
4	0	0	.48	0	0	0	0	0	0	0	0	0
5	0	0	0	0	0	0	0	0	0	0	0	0
6	0	0	0	0	0	0	0	0	0	0	0	0
7	0	0	0	0	0	0	1.66	.01	0	0	0	0
8	0	0	0	0	0	0	.03	.85	0	0	0	0
9	0	0	0	0	0	0	0	0	0	0	0	0
10	0	0	0	1.36	0	0	0	0	0	0	0	0
11	0	0	0	4.59	0	0	0	0	0	0	0	0
12	0	0	24.6	.02	0	0	0	0	0	0	0	0
13	0	0	0	0	0	0	0	0	0	0	0	0
14	0	0	.30	0	0	0	0	8.91	0	0	0	0
15	0	0	0	0	0	0	0	.23	0	0	0	22.1
16	0	0	.02	0	0	0	0	0	0	0	0	.05
17	0	0	3.14	0	0	0	0	0	0	0	0	0
18	0	0	0	0	0	0	0	0	0	.45	0	.02
19	0	0	0	0	0	0	0	0	0	.21	0	0
20	0	0	0	0	0	0	0	0	0	.10	0	0
21	0	0	0	0	0	0	0	0	0	.04	0	0
22	0	0	0	0	2.76	.03	0	0	0	0	0	0
23	0	0	0	0	.73	0	0	0	0	0	0	0
24	0	0	0	0	0	0	0	0	0	0	0	0
25	0	0	0	0	0	0	1.43	0	0	0	0	0
26	0	0	0	.51	0	0	.02	0	0	0	0	0
27	0	0	0	.06	0	0	0	0	0	0	0	0
28	0	0	0	0	.37	0	0	0	0	0	0	0
29	0	0	0	0	-----	0	0	0	0	0	0	0
30	0	2.37	1.91	0	-----	0	0	0	0	.42	0	0
31	0	-----	0	0	-----	0	-----	0	-----	0	0	-----
Total	0	6.74	54.09	6.54	3.86	4.15	3.14	10.00	0	1.22	0	22.17
Mean	0	.22	1.74	.21	.14	.13	.10	.32	0	.039	0	.74
Max	0	4.37	24.6	4.59	2.76	3.21	1.66	8.91	0	.45	0	22.1
Min	0	0	0	0	0	0	0	0	0	0	0	0
Acre-Ft	0	13	107	13	7.7	8.2	6.2	20	0	2.4	0	44
Wtr Year 2015	Total	111.91	Mean	.31	Max	24.6	Min	0	Inst Max	389	Acre-Ft	222
Cal Year 2014	Total	123.35	Mean	.34	Max	30.5	Min	0	Inst Max	389	Acre-Ft	245

RUNOFF – DAILY DISCHARGE

Los Angeles County Dept of Public works

USDAY V106 Output 03/16/2016

Summary Report

Site: F313B Rio Hondo Bypass Channel Above Whittier Narrows
 USGS #:
 Beginning Date: 10/01/2014
 Ending Date: 09/30/2015

Daily Mean Discharge in Cubic feet/second water Year Oct 2014 to Sep 2015

Day	OCT	NOV	DEC	JAN	FEB	MAR	APR	MAY	JUN	JUL	AUG	SEP
1	0	0	0	0	0	7.31	0	0	0	0	0	.96
2	0	0	0	0	0	7.68	0	0	0	0	0	2.00
3	0	0	.03	.01	0	7.92	0	0	0	0	0	2.09
4	0	0	.04	.01	0	8.08	0	0	0	0	0	3.57
5	0	0	0	0	0	8.39	0	0	0	0	0	4.67
6	0	0	0	0	0	7.85	0	0	0	0	0	4.37
7	0	0	0	.01	.01	7.70	0	0	0	0	0	3.32
8	0	0	0	.04	.01	8.48	0	0	0	0	0	3.60
9	0	0	0	.03	0	7.63	0	0	0	0	0	3.15
10	0	0	0	.06	0	8.27	0	0	0	0	0	2.99
11	0	0	0	.09	0	5.19	0	0	0	0	0	3.75
12	0	0	.03	.04	0	0	0	0	0	0	0	5.46
13	0	0	.10	.01	0	0	0	0	0	0	.62	4.31
14	0	0	.09	0	0	0	0	0	0	0	1.14	2.27
15	0	0	.03	0	0	0	0	0	0	0	1.89	5.52
16	0	0	.06	0	0	0	0	0	0	0	4.07	5.37
17	0	0	.02	0	0	0	0	0	0	0	1.76	5.20
18	0	0	0	0	0	0	0	0	0	0	1.59	4.80
19	0	0	0	0	0	0	0	0	0	0	4.78	4.99
20	0	0	0	.01	0	0	0	0	0	0	4.53	4.91
21	0	0	.01	.01	0	0	0	0	0	0	3.48	4.22
22	0	0	.03	0	0	0	0	0	0	0	3.62	4.04
23	0	0	.01	0	0	0	0	0	0	0	2.91	3.15
24	0	0	0	0	1.60	0	0	0	0	0	2.33	3.01
25	0	0	0	0	5.50	0	0	0	0	0	1.58	4.25
26	0	0	0	.02	6.11	0	0	0	0	0	1.49	4.42
27	0	0	0	.02	6.57	0	0	0	0	0	2.42	3.90
28	0	0	0	.01	6.87	0	0	0	0	0	3.47	2.32
29	0	0	0	0	-----	0	0	0	0	0	3.19	3.89
30	0	0	.01	.01	-----	0	0	0	0	0	3.39	4.83
31	0	-----	0	0	-----	0	-----	0	-----	0	1.21	-----
Total	0	0	0.46	0.38	26.67	84.50	0	0	0	0	49.47	115.33
Mean	0	0	.015	.012	.95	2.73	0	0	0	0	1.60	3.84
Max	0	0	.10	.09	6.87	8.48	0	0	0	0	4.78	5.52
Min	0	0	0	0	0	0	0	0	0	0	0	.96
Acre-Ft	0	0	.91	.75	53	168	0	0	0	0	98	229
wtr Year 2015	Total	276.81	Mean	.76	Max	8.48	Min	0	Inst Max	12.6	Acre-Ft	549
Cal Year 2014	Total	1973.31	Mean	5.41	Max	59.9	Min	0	Inst Max	117	Acre-Ft	3910

RUNOFF – DAILY DISCHARGE

Los Angeles County Dept of Public works

USDAY V106 Output 03/16/2016

Summary Report

Site: F338 Rubio Diversion Channel Below Gooseberry Canyon Inlet
 USGS #:
 Beginning Date: 10/01/2014
 Ending Date: 09/30/2015

Daily Mean Discharge in Cubic feet/second water Year Oct 2014 to Sep 2015

Day	OCT	NOV	DEC	JAN	FEB	MAR	APR	MAY	JUN	JUL	AUG	SEP
1	0	.99	0	.01	0	.05	0	0	0	0	0	.05
2	0	0	2.17	.02	0	.89	.07	0	0	0	0	0
3	0	0	1.05	.01	0	.03	.05	0	0	0	0	0
4	.09	0	.04	.03	0	.03	.01	0	.03	0	0	0
5	.15	0	0	0	0	.06	0	0	.03	0	0	0
6	.01	0	0	0	0	0	0	0	0	0	0	0
7	0	0	0	.01	.15	0	.54	.09	0	0	0	0
8	0	0	0	.02	0	0	0	.02	0	0	.02	0
9	0	0	0	0	0	0	0	0	0	.01	0	0
10	0	.14	.02	.98	0	0	.06	0	0	0	0	0
11	0	.08	0	1.15	0	0	0	.01	0	0	0	0
12	0	0	4.98	0	0	0	.03	0	0	0	0	0
13	0	0	.03	0	0	0	.20	.01	0	0	0	0
14	0	.30	0	0	.04	0	.20	3.48	0	0	0	0
15	0	0	0	0	0	0	.20	.11	0	0	0	3.04
16	0	0	.99	0	0	0	.20	0	0	0	0	.78
17	.09	0	1.50	0	0	0	.20	0	0	0	0	0
18	0	0	0	0	0	.04	.04	0	0	1.36	0	0
19	0	0	0	0	0	0	0	0	.07	1.88	.06	0
20	0	0	0	0	0	0	0	0	.15	.19	0	0
21	0	1.08	0	0	0	0	0	0	0	.20	0	0
22	0	0	0	0	1.71	0	0	0	0	.17	0	0
23	0	0	0	0	.93	0	0	0	.11	0	0	0
24	.01	0	0	0	0	0	0	0	.13	0	0	0
25	0	0	0	0	0	0	.33	0	.14	.14	0	0
26	0	0	0	.18	0	0	0	0	.11	.20	0	0
27	0	0	0	.01	.11	0	0	0	0	.20	0	0
28	0	0	.01	0	.17	0	0	0	0	.20	0	.01
29	0	0	0	0	-----	0	0	0	0	.20	0	.20
30	0	.97	0	0	-----	0	0	0	0	.09	0	0
31	.44	-----	0	0	-----	0	-----	0	-----	0	0	-----
Total	0.79	3.56	10.79	2.42	3.11	1.10	2.13	3.72	0.77	4.84	0.08	4.08
Mean	.025	.12	.35	.078	.11	.035	.071	.12	.026	.16	.003	.14
Max	.44	1.08	4.98	1.15	1.71	.89	.54	3.48	.15	1.88	.06	3.04
Min	0	0	0	0	0	0	0	0	0	0	0	0
Acre-Ft	1.6	7.1	21	4.8	6.2	2.2	4.2	7.4	1.5	9.6	.16	8.1
wtr Year 2015	Total	37.39	Mean	.10	Max	4.98	Min	0	Inst Max	183	Acre-Ft	74
Cal Year 2014	Total	26.87	Mean	.074	Max	4.98	Min	0	Inst Max	183	Acre-Ft	53

RUNOFF – DAILY DISCHARGE

Los Angeles County Dept of Public works

USDAY V106 Output 03/16/2016

Summary Report

Site: F82C Rubio Wash at Glendon way
 USGS #:
 Beginning Date: 10/01/2014
 Ending Date: 09/30/2015

Daily Mean Discharge in Cubic feet/second Water Year Oct 2014 to Sep 2015

Day	OCT	NOV	DEC	JAN	FEB	MAR	APR	MAY	JUN	JUL	AUG	SEP
1	.20	34.7	.69	.23	.15	1.03	.14	.32	.09	.22	.38	0
2	.20	.29	130	.04	.20	27.6	.23	.24	.06	.05	.14	0
3	.22	.34	22.9	.03	.19	.32	.15	.25	.04	.05	.22	.28
4	.16	.23	1.19	.05	.19	.06	.04	.55	.04	.01	.34	.27
5	.22	.28	.34	.05	.18	.10	.12	.39	.16	.01	.14	0
6	.23	.32	.41	.06	.13	.20	.13	.78	.02	.04	.20	0
7	.58	.26	.20	.05	.45	.12	12.6	.56	.01	.09	.15	0
8	.29	.29	.26	.15	.21	.12	.52	3.03	.16	.05	.22	0
9	.25	.39	.16	.16	.17	.28	.42	.41	.04	.05	.02	0
10	.23	.48	.21	6.67	.12	.22	.34	.32	.10	.19	.06	0
11	.21	.41	.19	7.84	.10	.23	.25	.32	.11	.01	.21	0
12	.22	.45	229	.40	.09	.21	.26	.48	.05	0	.14	.03
13	.20	.39	.46	.20	.16	.16	.36	.35	.03	.26	0	0
14	.26	.42	.26	.12	.11	.23	.37	64.4	.03	.23	.03	0
15	.23	.41	.29	.09	.09	.14	.31	.82	.08	.15	.12	205
16	.24	.32	3.72	.10	.17	.53	.37	.18	.04	.09	.17	.18
17	.19	.39	29.4	.11	.28	.37	.27	.12	.06	.03	.22	0
18	.12	.28	.15	.14	.26	.46	.27	.20	.10	2.97	.36	0
19	.16	.19	.13	.15	.29	.27	.29	.17	.06	2.47	.54	0
20	.63	.28	.16	.21	.51	.24	.44	.35	.01	1.29	.10	0
21	.20	.36	.11	.30	.34	.10	.43	.12	.03	.56	.19	0
22	.16	.22	.14	.14	22.2	.15	.44	.07	.09	.59	.19	0
23	.12	.25	.15	.07	29.9	.22	.55	.04	.08	.43	.06	0
24	.14	.26	.10	.06	.54	.23	.47	.01	.06	.34	0	0
25	.12	.26	.07	.02	.27	.16	13.5	.04	.07	.59	.27	0
26	.16	.18	.05	2.11	.26	.14	.30	.08	.08	.31	.25	0
27	.25	.20	.04	.40	.29	.11	.23	.06	.04	.44	.02	0
28	.30	.18	.10	.09	.96	.07	.19	.11	.05	.74	.08	0
29	.13	.20	.10	.34	-----	.09	.24	.05	.08	.62	.16	0
30	.23	4.62	3.61	.23	-----	.23	.25	.07	.20	.73	.28	0
31	3.54	-----	.16	.18	-----	.17	-----	.02	-----	.53	.06	-----
Total	10.39	47.85	424.75	20.79	58.81	34.56	34.48	74.91	2.07	14.14	5.32	205.76
Mean	.34	1.60	13.7	.67	2.10	1.11	1.15	2.42	.069	.46	.17	6.86
Max	3.54	34.7	229	7.84	29.9	27.6	13.5	64.4	.20	2.97	.54	205
Min	.12	.18	.04	.02	.09	.06	.04	.01	.01	0	0	0
Acre-Ft	21	95	842	41	117	69	68	149	4.1	28	11	408
wtr Year 2015	Total	933.83	Mean	2.56	Max	229	Min	0	Inst Max	2900	Acre-Ft	1850
Cal Year 2014	Total	950.40	Mean	2.60	Max	284	Min	.04	Inst Max	2900	Acre-Ft	1890

RUNOFF – DAILY DISCHARGE

Los Angeles County Dept of Public works

USDAY V106 Output 03/16/2016

Summary Report

Site: F303 San Dimas Creek Below San Dimas Dam
 USGS #:
 Beginning Date: 10/01/2014
 Ending Date: 09/30/2015

Daily Mean Discharge in Cubic feet/second water Year Oct 2014 to Sep 2015

Day	OCT	NOV	DEC	JAN	FEB	MAR	APR	MAY	JUN	JUL	AUG	SEP
1	.23	.02	0	.06	.08	.08	.24	.13	.26	.32	.17	.10
2	.23	.01	0	.07	.08	.10	.24	.12	.27	.31	.18	.11
3	.22	.01	0	.09	.08	.12	.24	.12	.29	.28	.18	.13
4	.21	0	0	.09	.08	.11	.25	.11	.32	.19	.22	.13
5	.20	0	0	.10	.08	.06	.25	9.14	.30	.20	.21	.11
6	.19	0	0	.03	.08	.02	.26	14.2	.31	.25	.25	.09
7	.19	0	0	.09	.08	.03	.26	8.12	.31	.27	.23	.08
8	.18	0	0	.12	.08	.19	.26	.11	.30	.30	.22	.07
9	.17	0	.01	.12	.08	.21	.27	.12	.36	.34	.22	.08
10	.16	0	.02	.12	.08	.22	.27	.12	.38	.33	.22	.07
11	.15	0	0	.12	.08	.18	.27	4.80	.39	.33	.21	.09
12	.14	0	0	.12	.08	.16	.28	1.90	.37	.31	.15	.08
13	.14	0	0	.12	.08	.17	.14	.04	.27	.28	.11	.11
14	.13	0	0	.12	.08	.17	.14	.03	.25	.28	.11	.12
15	.12	0	0	.12	.08	.17	.16	.02	.25	.28	.10	.30
16	.11	0	0	.12	.08	.18	.16	.02	.23	.26	.09	.14
17	.11	0	0	.12	.08	.18	.15	.02	.22	.24	.10	.10
18	.10	0	0	.12	.08	.19	.15	21.0	.23	.27	.07	.08
19	.10	0	0	.12	.08	.19	.15	26.8	.26	.19	.05	.08
20	.09	0	0	.12	.08	.19	.15	20.7	.25	.17	.08	.07
21	.08	0	0	.12	.08	.20	.15	21.7	.29	.16	.08	.08
22	.08	0	0	.12	.08	.20	.14	.55	.26	.18	.08	.09
23	.07	0	0	.12	.08	.20	.14	.47	.27	.19	.10*	.09
24	.07	0	.02	.12	.08	.21	.14	.39	.29	.20	.09*	.07
25	.06	0	.02	.12	.08	.21	.14	.36	.36	.21	.11	.08
26	.05	0	.08	.12	.08	.21	.14	.32	.31	.24	.08	.06
27	.05	0	.04	.12	.08	.22	.13	.26	.33	.25	.06	.05
28	.04	0	.02	.12	.08	.22	.13	.23	.33	.24	.07	.04
29	.04	0	.03	.10	-----	.23	.13	.24	.32	.22	.05	.05
30	.03	0	.04	.08	-----	.23	.13	.26	.30	.18	.05	.05
31	.02	-----	.03	.08	-----	.23	-----	.26	-----	.17	.09	-----
Total	3.76	0.04	0.31	3.31	2.24	5.28	5.66	132.66	8.88	7.64	4.03	2.80
Mean	.12	.001	.010	.11	.080	.17	.19	4.28	.30	.25	.13	.093
Max	.23	.02	.08	.12	.08	.23	.28	26.8	.39	.34	.25	.30
Min	.02	0	0	.03	.08	.02	.13	.02	.22	.16	.05	.04
Acre-Ft	7.5	.08	.61	6.6	4.4	10	11	263	18	15	8.0	5.6
Wtr Year 2015	Total	176.61	Mean	.48	Max	26.8	Min	0	Inst Max	62.0	Acre-Ft	350
Cal Year 2014	Total	235.80	Mean	.65	Max	61.3	Min	0	Inst Max	114	Acre-Ft	468

RUNOFF – DAILY DISCHARGE

Los Angeles County Dept of Public works

USDAY V106 Output 03/16/2016

Summary Report

Site: F218 San Dimas Wash Below Puddingstone Diversion Dam
 USGS #:
 Beginning Date: 10/01/2014
 Ending Date: 09/30/2015

Daily Mean Discharge in Cubic feet/second water Year Oct 2014 to Sep 2015

Day	OCT	NOV	DEC	JAN	FEB	MAR	APR	MAY	JUN	JUL	AUG	SEP
1	0	0	0	0	0	0	0	0	0	0	0	0
2	0	0	0	0	0	0	0	0	0	0	0	0
3	0	0	0	0	0	0	0	0	0	0	0	0
4	0	0	0	0	0	0	0	0	0	0	0	0
5	0	0	0	0	0	0	0	0	0	0	0	0
6	0	0	0	0	0	0	0	1.54	0	0	0	0
7	0	0	0	0	0	0	0	5.19	0	0	0	0
8	0	0	0	0	0	0	0	5.08	0	0	0	0
9	0	0	0	0	0	0	0	3.55	0	0	0	0
10	0	0	0	0	0	0	0	3.00	0	0	0	0
11	0	0	0	0	0	0	0	2.91	0	0	0	0
12	0	0	0	0	0	0	0	2.79	0	0	0	0
13	0	0	0	0	0	0	0	2.54	0	0	0	0
14	0	0	0	0	0	0	0	2.29	0	0	0	0
15	0	0	0	0	0	0	0	1.97	0	0	0	0
16	0	0	0	0	0	0	0	.45	0	0	0	0
17	0	0	0	0	0	0	0	0	0	0	0	0
18	0	0	0	0	0	0	0	1.06	0	0	0	0
19	0	0	0	0	0	0	0	3.52	0	0	0	0
20	0	0	0	0	0	0	0	5.12	0	0	0	0
21	0	0	0	0	0	0	0	5.72	0	0	0	0
22	0	0	0	0	0	0	0	5.59	0	0	0	0
23	0	0	0	0	0	0	0	5.19	0	0	0	0
24	0	0	0	0	0	0	0	3.74	0	0	0	0
25	0	0	0	0	0	0	0	3.00	0	0	0	0
26	0	0	0	0	0	0	0	3.44	0	0	0	0
27	0	0	0	0	0	0	0	3.20	0	0	0	0
28	0	0	0	0	0	0	0	2.64	0	0	0	0
29	0	0	0	0	-----	0	0	1.41	0	0	0	0
30	0	0	0	0	-----	0	0	.17	0	0	0	0
31	0	-----	0	0	-----	0	-----	0	-----	0	0	-----
Total	0	0	0	0	0	0	0	75.11	0	0	0	0
Mean	0	0	0	0	0	0	0	2.42	0	0	0	0
Max	0	0	0	0	0	0	0	5.72	0	0	0	0
Min	0	0	0	0	0	0	0	0	0	0	0	0
Acre-Ft	0	0	0	0	0	0	0	149	0	0	0	0
wtr Year 2015	Total	75.11	Mean	.21	Max	5.72	Min	0	Inst Max	5.81	Acre-Ft	149
Cal Year 2014	Total	28.41	Mean	.078	Max	7.64	Min	0	Inst Max	8.55	Acre-Ft	56

RUNOFF – DAILY DISCHARGE

Los Angeles County Dept of Public works

USDAY V106 Output 03/16/2016

Summary Report

Site: F250 San Gabriel River - Azusa Conduit 25 Ft. Weir Below Dam
 USGS #:
 Beginning Date: 10/01/2014
 Ending Date: 09/30/2015

Daily Mean Discharge in Cubic feet/second water Year Oct 2014 to Sep 2015

Day	OCT	NOV	DEC	JAN	FEB	MAR	APR	MAY	JUN	JUL	AUG	SEP
1	0	0	0	0	0	0	18.8	14.8	0	34.5	34.5	33.5
2	0	0	0	0	0	0	18.8	14.8	0	34.5	34.4	33.5
3	0	0	0	0	0	0	18.8	14.9	0	34.4	34.4	33.5
4	0	0	0	0	0	0	18.8	14.9	0	34.4	34.3	33.4
5	0	0	0	0	0	0	18.8	14.9	0	34.4	34.2	33.5
6	0	0	0	0	0	0	5.29	4.42	0	34.3	34.0	33.5
7	0	0	0	0	0	0	2.22	0	0	34.4	33.9	33.5
8	0	0	0	0	0	0	14.3	0	0	34.2	33.9	33.5
9	0	0	0	0	0	0	18.7	0	0	34.1	33.8	34.4
10	0	0	0	0	0	.93	18.8	0	0	34.3	33.6	14.6
11	0	0	0	0	0	2.54	18.8	0	0	34.2	33.4	0
12	0	0	0	0	0	7.55	18.7	0	0	34.4	33.2	0
13	0	0	0	0	0	9.36	18.8	0	0	34.4	33.0	0
14	0	0	0	0	0	9.32	18.7	0	0	34.4	32.8	0
15	0	0	0	0	0	9.28	18.7	0	0	34.5	32.7	0
16	0	0	0	0	0	9.30	18.8	0	0	34.6	32.6	0
17	0	0	0	0	0	9.28	18.7	0	0	34.6	32.5	0
18	0	0	0	0	0	9.27	18.8	0	0	34.6	32.5	0
19	0	0	0	0	0	9.28	18.8	0	0	34.6	33.0	0
20	0	0	0	0	0	9.25	12.7	0	0	34.5	33.6	0
21	0	0	0	0	0	9.25	9.60	0	0	34.7	33.5	0
22	0	0	0	0	0	9.25	9.47	0	0	34.7	33.4	0
23	0	0	0	0	0	2.77	9.48	0	0	34.7	33.4	0
24	0	0	0	0	0	0	9.49	0	0	34.8	33.5	0
25	0	0	0	0	0	1.32	9.49	0	1.32	34.8	33.4	0
26	0	0	0	0	0	13.7	9.49	0	1.90	34.9	33.5	0
27	0	0	0	0	0	18.8	9.51	0	1.81	34.9	33.4	0
28	0	0	0	0	0	18.8	9.54	0	1.80	34.9	33.4	0
29	0	0	0	0	-----	18.8	9.57	0	2.07	34.7	33.5	0
30	0	0	0	0	-----	18.8	13.1	0	24.4	34.5	33.5	0
31	0	-----	0	0	-----	18.8	-----	0	-----	34.5	33.4	-----
Total	0	0	0	0	0	215.65	433.55	78.72	33.30	1070.4	1038.2	316.9
Mean	0	0	0	0	0	6.96	14.5	2.54	1.11	34.5	33.5	10.6
Max	0	0	0	0	0	18.8	18.8	14.9	24.4	34.9	34.5	34.4
Min	0	0	0	0	0	0	2.22	0	0	34.1	32.5	0
Acre-Ft	0	0	0	0	0	428	860	156	66	2120	2060	629
wtr Year 2015	Total	3186.72	Mean	8.73	Max	34.9	Min	0	Inst Max	40.7	Acre-Ft	6320
Cal Year 2014	Total	4990.10	Mean	13.7	Max	81.1	Min	0	Inst Max	116	Acre-Ft	9900

RUNOFF – DAILY DISCHARGE

Los Angeles County Dept of Public works

USDAY V106 Output 03/16/2016

Summary Report

Site: F220B San Gabriel - Azusa Conduit 10 Ft. Weir Below S.G. Dam
 USGS #:
 Beginning Date: 10/01/2014
 Ending Date: 09/30/2015

Daily Mean Discharge in Cubic feet/second water Year Oct 2014 to Sep 2015

Day	OCT	NOV	DEC	JAN	FEB	MAR	APR	MAY	JUN	JUL	AUG	SEP
1	0	0	0	0	0	0	22.0	13.0	0	34.4	34.0	33.5
2	0	0	0	0	0	0	28.4	13.0	0	34.4	34.0	33.4
3	0	0	0	0	0	0	35.3	13.2	0	34.4	33.9	33.5
4	0	0	0	0	0	0	42.6	13.3	0	34.4	33.9	33.5
5	0	0	0	0	0	0	50.5	13.4	0	34.3	33.9	33.5
6	0	0	0	0	0	0	23.8	3.92	0	34.3	33.8	33.4
7	0	0	0	0	0	0	2.02	0	0	34.3	33.7	33.4
8	0	0	0	0	0	0	12.2	0	0	34.3	33.6	33.3
9	0	0	0	0	0	0	15.9	0	0	34.1	33.6	34.1
10	0	0	0	0	0	.90	15.9	0	0	34.0	33.6	14.2
11	0	0	0	0	0	2.55	15.9	0	0	34.0	33.6	0
12	0	0	0	0	0	7.53	15.9	0	0	34.0	33.2	0
13	0	0	0	0	0	9.17	15.9	0	0	34.0	33.0	0
14	0	0	0	0	0	9.17	15.9	0	0	34.0	32.9	0
15	0	0	0	0	0	9.17	15.9	0	0	34.1	32.9	0
16	0	0	0	0	0	9.17	15.9	0	0	34.0	32.8	0
17	0	0	0	0	0	9.17	15.9	0	0	34.0	32.9	0
18	0	0	0	0	0	9.17	16.0	0	0	34.0	32.9	0
19	0	0	0	0	0	9.17	16.0	0	0	34.0	32.9	0
20	0	0	0	0	0	9.17	11.0	0	0	34.0	33.5	0
21	0	0	0	0	0	9.17	8.41	0	0	34.0	33.5	0
22	0	0	0	0	0	9.17	8.41	0	0	34.0	33.5	0
23	0	0	0	0	0	2.75	8.41	0	0	34.0	33.5	0
24	0	0	0	0	0	0	8.41	0	0	34.0	33.5	0
25	0	0	0	0	0	1.26	8.41	0	1.32	34.1	33.5	0
26	0	0	0	0	0	13.4	8.41	0	1.89	34.1	33.4	0
27	0	0	0	0	0	19.0	8.41	0	1.81	34.1	33.4	0
28	0	0	0	0	0	19.0	8.41	0	1.79	34.0	33.4	0
29	0	0	0	0	-----	19.0	8.59	0	2.06	34.0	33.3	0
30	0	0	0	0	-----	19.0	11.8	0	24.1	34.0	33.4	0
31	0	-----	0	0	-----	19.0	-----	0	-----	34.0	33.4	-----
Total	0	0	0	0	0	215.09	490.59	69.82	32.97	1057.3	1036.4	315.8
Mean	0	0	0	0	0	6.94	16.4	2.25	1.10	34.1	33.4	10.5
Max	0	0	0	0	0	19.0	50.5	13.4	24.1	34.4	34.0	34.1
Min	0	0	0	0	0	0	2.02	0	0	34.0	32.8	0
Acre-Ft	0	0	0	0	0	427	973	138	65	2100	2060	626
wtr Year 2015	Total	3217.97	Mean	8.82	Max	50.5	Min	0	Inst Max	54.6	Acre-Ft	6380
Cal Year 2014	Total	333.67	Mean	.91	Max	14.1	Min	0	Inst Max	14.1	Acre-Ft	662

RUNOFF – DAILY DISCHARGE

Los Angeles County Dept of Public works

USDAY V106 Output 03/16/2016

Summary Report

Site: F262C San Gabriel River Above Firestone Ave.
 USGS #:
 Beginning Date: 10/01/2014
 Ending Date: 09/30/2015

Daily Mean Discharge in Cubic feet/second water Year Oct 2014 to Sep 2015

Day	OCT	NOV	DEC	JAN	FEB	MAR	APR	MAY	JUN	JUL	AUG	SEP
1	0	0	0	0	0	0	0	0	0	0	0	0
2	0	0	0	0	0	0	0	0	0	0	0	0
3	0	0	0	0	0	0	0	0	0	0	0	0
4	0	0	0	0	0	0	0	0	0	0	0	0
5	0	0	0	0	0	0	0	0	0	0	0	0
6	0	0	0	0	0	0	0	0	0	0	0	0
7	0	0	0	0	0	0	0	0	0	0	0	0
8	0	0	0	0	0	0	0	0	0	0	0	0
9	0	0	0	0	0	0	0	0	0	0	0	0
10	0	0	0	0	0	0	0	0	0	0	0	0
11	0	0	0	0	0	0	0	0	0	0	0	0
12	0	0	0	0	0	0	0	0	0	0	0	0
13	0	0	0	0	0	0	0	0	0	0	0	0
14	0	0	0	0	0	0	0	0	0	0	0	0
15	0	0	0	0	0	0	0	0	0	0	0	0
16	0	0	0	0	0	0	0	0	0	0	0	0
17	0	0	0	0	0	0	0	0	0	0	0	0
18	0	0	0	0	0	0	0	0	0	0	0	0
19	0	0	0	0	0	0	0	0	0	0	0	0
20	0	0	0	0	0	0	0	0	0	0	0	0
21	0	0	0	0	0	0	0	0	0	0	0	0
22	0	0	0	0	0	0	0	0	0	0	0	0
23	0	0	0	0	0	0	0	0	0	0	0	0
24	0	0	0	0	0	0	0	0	0	0	0	0
25	0	0	0	0	0	0	0	0	0	0	0	0
26	0	0	0	0	0	0	0	0	0	0	0	0
27	0	0	0	0	0	0	0	0	0	0	0	0
28	0	0	0	0	0	0	0	0	0	0	0	0
29	0	0	0	0	-----	0	0	0	0	0	0	0
30	0	0	0	0	-----	0	0	0	0	0	0	0
31	0	-----	0	0	-----	0	-----	0	-----	0	0	-----
Total	0	0	0	0	0	0	0	0	0	0	0	0
Mean	0	0	0	0	0	0	0	0	0	0	0	0
Max	0	0	0	0	0	0	0	0	0	0	0	0
Min	0	0	0	0	0	0	0	0	0	0	0	0
Acre-Ft	0	0	0	0	0	0	0	0	0	0	0	0
Wtr Year 2015	Total	0	Mean	0	Max	0	Min	0	Inst Max	0	Acre-Ft	0
Cal Year 2014	Total	0	Mean	0	Max	0	Min	0	Inst Max	0	Acre-Ft	0

RUNOFF – DAILY DISCHARGE

Los Angeles County Dept of Public works

USDAY V106 Output 03/16/2016

Summary Report

Site: F42B San Gabriel River Above Spring Street
 USGS #:
 Beginning Date: 10/01/2014
 Ending Date: 09/30/2015

Daily Mean Discharge in Cubic feet/second water Year Oct 2014 to Sep 2015

Day	OCT	NOV	DEC	JAN	FEB	MAR	APR	MAY	JUN	JUL	AUG	SEP
1	51.3	169	115	51.1	84.6	71.4	103	81.0	36.6	37.9	69.0	36.8
2	47.8	86.2	382	77.5	131	141	95.4	77.8	37.4	39.6	72.7	34.2
3	48.1	96.1	278	68.6	142	72.5	77.9	75.1	32.7	37.9	65.4	34.2
4	49.1	95.1	137	63.0	104	71.9	82.8	70.6	34.9	39.9	69.5	34.0
5	47.6	81.8	104	66.9	147	70.2	74.2	75.5	35.0	34.8	71.2	35.7
6	45.3	76.5	104	73.7	320	69.3	66.3	73.5	38.8	35.8	67.5	31.4
7	44.0	81.7	96.9	76.2	267	70.5	73.7	80.1	38.0	39.4	76.4	32.5
8	47.0	103	83.1	76.0	221	70.2	79.1	120	37.1	61.4	72.5	33.2
9	42.8	105	16.2	79.0	185	67.3	72.9	82.2	38.8	76.8	76.4	32.5
10	45.5	108	.35	103	129	69.1	72.0	80.0	39.1	68.8	66.0	32.3
11	44.5	96.2	.35	274	111	76.1	75.7	78.3	39.3	70.2	69.1	32.9
12	39.2	83.8	1.59	197	97.9	69.4	77.1	73.4	36.6	68.9	63.1	29.3
13	38.7	41.7	.35	218	105	68.8	73.0	73.8	40.2	56.9	66.7	23.3
14	37.3	42.6	.35	195	103	70.6	83.3	213	35.8	64.0	68.3	22.2
15	38.7	42.3	.35	168	103	66.7	74.9	124	32.0	57.5	72.9	54.0
16	37.7	41.5	.31	164	75.4	65.3	77.5	88.7	31.1	56.5	71.1	59.0
17	37.3	41.6	.56	103	52.8	69.4	73.6	77.7	29.2	55.9	66.0	58.2
18	40.9	41.2	41.9	96.7	55.0	74.5	79.6	75.6	27.7	136	69.1	58.0
19	38.8	41.2	147	98.4	80.5	69.3	80.6	72.4	24.8	86.8	65.5	62.4
20	38.9	43.2	157	97.1	77.2	102	76.4	61.6	27.4	69.9	65.0	57.9
21	40.2	43.5	162	114	74.8	97.9	69.4	63.6	32.7	71.5	66.1	55.1
22	40.1	43.7	108	203	91.5	81.1	43.7	63.1	34.4	70.7	71.8	50.9
23	38.1	40.8	54.6	282	108	77.5	44.6	68.3	34.1	72.6	72.2	30.9
24	39.7	41.0	58.7	288	74.3	88.9	43.0	71.6	39.4	66.6	54.3	38.1
25	43.6	42.7	54.3	292	71.3	82.2	44.8	72.5	39.0	72.1	38.7	37.6
26	39.7	42.1	54.2	339	71.1	81.4	43.3	73.3	38.5	70.9	37.5	37.5
27	38.9	42.4	52.6	286	72.7	77.5	43.4	64.2	41.4	63.7	35.3	36.6
28	42.0	33.4	49.2	167	70.1	85.7	41.9	64.9	38.0	64.4	33.7	38.3
29	58.3	37.8	52.8	75.3	-----	82.3	46.9	37.7	37.0	64.9	37.7	38.9
30	87.1	77.5	55.3	78.7	-----	79.2	60.8	38.2	38.8	65.6	36.7	37.9
31	79.9	-----	57.8	79.9	-----	81.3	-----	35.4	-----	64.9	37.2	-----
Total	1408.1	1962.6	2425.81	4551.1	3225.2	2420.5	2050.8	2407.1	1065.8	1942.8	1904.6	1195.8
Mean	45.4	65.4	78.3	147	115	78.1	68.4	77.6	35.5	62.7	61.4	39.9
Max	87.1	169	382	339	320	141	103	213	41.4	136	76.4	62.4
Min	37.3	33.4	.31	51.1	52.8	65.3	41.9	35.4	24.8	34.8	33.7	22.2
Acre-Ft	2790	3890	4810	9030	6400	4800	4070	4770	2110	3850	3780	2370
wtr Year 2015	Total	26560.21	Mean	72.8	Max	382	Min	.31	Inst Max	1340	Acre-Ft	52680
Cal Year 2014	Total	25839.11	Mean	70.8	Max	479	Min	.31	Inst Max	1500	Acre-Ft	51250

RUNOFF – DAILY DISCHARGE

Los Angeles County Dept of Public works

USDAY V106 Output 03/16/2016

Summary Report

Site: F263C San Gabriel River Below San Gabriel River Parkway
 USGS #:
 Beginning Date: 10/01/2014
 Ending Date: 09/30/2015

Daily Mean Discharge in Cubic feet/second water Year Oct 2014 to Sep 2015

Day	OCT	NOV	DEC	JAN	FEB	MAR	APR	MAY	JUN	JUL	AUG	SEP
1	0	164	167	0	13.7	127	178	.38	0	.03	0	0
2	.01	9.96	314	0	13.4	150	192	.37	0	.03	0	0
3	.03	0	343	.12	85.9	47.2	203	.36	0	.04	0	0
4	.02	0	175	.24	97.8	28.7	203	.36	0	.03	0	0
5	.01	0	21.1	.25	80.7	104	205	.36	0	.02	0	0
6	.01	0	13.6	.29	81.2	138	209	.93	0	.02	0	0
7	.01	0	10.8	.27	99.9	172	170	.36	0	.03	0	0
8	0	0	10.9	.28	120	180	149	265	0	.02	0	0
9	0	0	8.96	.27	116	182	211	16.7	0	.04	0	0
10	0	0	8.31	24.0	101	257	201	10.2	0	.05	0	0
11	0	0	8.34	524	102	164	204	5.79	0	.05	0	0
12	0	0	532	16.1	101	211	205	2.82	0	.05	0	0
13	0	0	79.3	.26	77.4	214	208	5.28	0	.05	0	0
14	0	0	21.3	60.9	77.6	201	155	69.5	0	.05	0	0
15	0	0	19.3	100	79.7	207	16.4	261	0	.05	0	347
16	0	0	14.1	103	79.0	206	9.08	19.9	0	.05	0	26.9
17	0	0	348	100	76.7	211	8.66	15.1	0	.05	0	4.83
18	0	0	36.4	101	88.8	210	8.68	15.2	.01	13.9	0	2.03
19	0	0	12.0	100	108	205	8.15	10.9	.02	93.1	0	0
20	0	0	0	101	115	180	9.38	10.4	.01	125	0	0
21	0	0	0	104	117	191	7.21	8.74	0	4.25	0	0
22	0	0	.52	79.2	129	209	4.99	10.0	.03	2.55	0	0
23	0	0	6.44	59.7	256	212	.36	7.42	.03	2.05	0	0
24	0	0	0	60.8	81.6	200	.36	9.87	.03	0	0	0
25	0	0	0	46.4	115	201	.36	11.0	.02	.01	0	0
26	0	0	0	37.1	118	202	4.35	14.5	.02	0	0	0
27	0	0	.02	64.1	118	208	.36	12.4	0	.01	0	0
28	0	0	.01	.28	120	199	.37	12.8	.03	.01	0	0
29	0	0	0	.34	-----	201	.37	8.79	.03	.01	0	0
30	0	40.0	0	14.1	-----	206	.37	.36	.03	.01	0	0
31	0	-----	.01	11.7	-----	206	-----	.18	-----	.01	0	-----
Total	0.09	213.96	2150.41	1709.70	2769.4	5629.9	2772.45	806.97	0.26	241.57	0	380.76
Mean	.003	7.13	69.4	55.2	98.9	182	92.4	26.0	.009	7.79	0	12.7
Max	.03	164	532	524	256	257	211	265	.03	125	0	347
Min	0	0	0	0	13.4	28.7	.36	.18	0	0	0	0
Acre-Ft	.18	424	4270	3390	5490	11170	5500	1600	.52	479	0	755
wtr Year 2015	Total	16675.47	Mean	45.7	Max	532	Min	0	Inst Max	1670	Acre-Ft	33080
Cal Year 2014	Total	3495.56	Mean	9.58	Max	532	Min	0	Inst Max	1670	Acre-Ft	6930

RUNOFF – DAILY DISCHARGE

Los Angeles County Dept of Public works

USDAY V106 Output 03/16/2016

Summary Report

Site: F190 San Gabriel River at Foothill Boulevard
 USGS #:
 Beginning Date: 10/01/2014
 Ending Date: 09/30/2015

Daily Mean Discharge in Cubic feet/second water Year Oct 2014 to Sep 2015

Day	OCT	NOV	DEC	JAN	FEB	MAR	APR	MAY	JUN	JUL	AUG	SEP
1	0	0	0	0	0	0	0	0	0	0	0	0
2	0	0	0	0	0	0	0	0	0	0	0	0
3	0	0	0	0	0	0	0	0	0	0	0	0
4	0	0	0	0	0	0	0	0	0	0	0	0
5	0	0	0	0	0	0	0	0	0	0	0	0
6	0	0	0	0	0	0	0	0	0	0	0	0
7	0	0	0	0	0	0	0	0	0	0	0	0
8	0	0	0	0	0	0	0	0	0	0	0	0
9	0	0	0	0	0	0	0	0	0	0	0	0
10	0	0	0	0	0	0	0	0	0	0	0	0
11	0	0	0	0	0	0	0	0	0	0	0	0
12	0	0	3.89	0	0	0	0	0	0	0	0	0
13	0	0	7.05	0	0	0	0	0	0	0	0	0
14	0	0	6.17	0	0	0	0	0	0	0	0	0
15	0	0	6.02	0	0	0	0	0	0	0	0	0
16	0	0	5.97	0	0	0	0	0	0	0	0	0
17	0	0	6.64	0	0	0	0	0	0	0	0	0
18	0	0	0	0	0	0	0	0	0	0	0	0
19	0	0	0	0	0	0	0	0	4.02	0	0	0
20	0	0	0	0	0	0	0	0	7.06	0	0	0
21	0	0	0	0	0	0	0	0	6.83	0	0	0
22	0	0	0	0	0	0	0	0	6.74	0	0	0
23	0	0	0	0	0	0	0	0	6.59	0	0	0
24	0	0	0	0	0	0	0	0	6.42	0	0	0
25	0	0	0	0	0	0	0	0	6.36	0	0	0
26	0	0	0	0	0	0	0	0	6.19	0	0	0
27	0	0	0	0	0	0	0	0	6.12	0	0	0
28	0	0	0	0	0	0	0	0	5.99	0	0	0
29	0	0	0	0	-----	0	0	0	5.79	0	0	0
30	0	0	0	0	-----	0	0	0	2.02	0	0	0
31	0	-----	0	0	-----	0	-----	0	-----	0	0	-----
Total	0	0	35.74	0	0	0	0	0	70.13	0	0	0
Mean	0	0	1.15	0	0	0	0	0	2.34	0	0	0
Max	0	0	7.05	0	0	0	0	0	7.06	0	0	0
Min	0	0	0	0	0	0	0	0	0	0	0	0
Acre-Ft	0	0	71	0	0	0	0	0	139	0	0	0
wtr Year 2015	Total	105.87	Mean	.29	Max	7.06	Min	0	Inst Max	13.2	Acre-Ft	210
Cal Year 2014	Total	307.76	Mean	.84	Max	12.1	Min	0	Inst Max	40.5	Acre-Ft	610

RUNOFF – DAILY DISCHARGE

Los Angeles County Dept of Public works

USDAY V106 Output 03/16/2016

Summary Report

Site: E281 San Gabriel River below Santa Fe Dam
 USGS #:
 Beginning Date: 10/01/2014
 Ending Date: 09/30/2015

Daily Mean Discharge in Cubic feet/second water Year Oct 2014 to Sep 2015

Day	OCT	NOV	DEC	JAN	FEB	MAR	APR	MAY	JUN	JUL	AUG	SEP
1	0	0	0	0	0	0	0	0	0	0	0	0
2	0	0	0	0	0	0	0	0	0	0	0	0
3	0	0	0	0	0	0	0	0	0	0	0	0
4	0	0	0	0	0	0	0	0	0	0	0	0
5	0	0	0	0	0	0	0	0	0	0	0	0
6	0	0	0	0	0	0	0	0	0	0	0	0
7	0	0	0	0	0	0	0	0	0	0	0	0
8	0	0	0	0	0	0	0	0	0	0	0	0
9	0	0	0	0	0	0	0	0	0	0	0	0
10	0	0	0	0	0	0	0	0	0	0	0	0
11	0	0	0	0	0	0	0	0	0	0	0	0
12	0	0	0	0	0	0	0	0	0	0	0	0
13	0	0	0	0	0	0	0	0	0	0	0	0
14	0	0	0	0	0	0	0	0	0	0	0	0
15	0	0	0	0	0	0	0	0	0	0	0	0
16	0	0	0	0	0	0	0	0	0	0	0	0
17	0	0	0	0	0	0	0	0	0	0	0	0
18	0	0	0	0	0	0	0	0	0	0	0	0
19	0	0	0	0	0	0	0	0	0	0	0	0
20	0	0	0	0	0	0	0	0	0	0	0	0
21	0	0	0	0	0	0	0	0	0	0	0	0
22	0	0	0	0	0	0	0	0	0	0	0	0
23	0	0	0	0	0	0	0	0	0	0	0	0
24	0	0	0	0	0	0	0	0	0	0	0	0
25	0	0	0	0	0	0	0	0	0	0	0	0
26	0	0	0	0	0	0	0	0	0	0	0	0
27	0	0	0	0	0	0	0	0	0	0	0	0
28	0	0	0	0	0	0	0	0	0	0	0	0
29	0	0	0	0	-----	0	0	0	0	0	0	0
30	0	0	0	0	-----	0	0	0	0	0	0	0
31	0	-----	0	0	-----	0	-----	0	-----	0	0	-----
Total	0	0	0	0	0	0	0	0	0	0	0	0
Mean	0	0	0	0	0	0	0	0	0	0	0	0
Max	0	0	0	0	0	0	0	0	0	0	0	0
Min	0	0	0	0	0	0	0	0	0	0	0	0
Acre-Ft	0	0	0	0	0	0	0	0	0	0	0	0
wtr Year 2015	Total	0	Mean	0	Max	0	Min	0	Inst Max	0	Acre-Ft	0
Cal Year 2014	Total	0	Mean	0	Max	0	Min	0	Inst Max	0	Acre-Ft	0

RUNOFF – DAILY DISCHARGE

Los Angeles County Dept of Public works

USDAY V106 Output 03/16/2016

Summary Report

Site: F209 San Gabriel River - West Fork Below Cogswell Dam
 USGS #:
 Beginning Date: 10/01/2014
 Ending Date: 09/30/2015

Daily Mean Discharge in Cubic feet/second Water Year Oct 2014 to Sep 2015

Day	OCT	NOV	DEC	JAN	FEB	MAR	APR	MAY	JUN	JUL	AUG	SEP
1	.99	.91	1.15	0	1.80	2.45	3.04	1.38	1.30	1.27	1.43	1.84
2	.93	.70	1.19	0	1.71	2.77	3.02	1.39	1.30	1.40	1.45	1.85
3	.93	.69	1.25	0	1.69	2.93	2.95	1.41	1.30	1.33	1.47	1.82
4	.92	.72	1.08	1.47	1.70	2.93	2.92	1.38	1.30	1.25	1.38	1.83
5	.93	.73	.99	1.83	1.72	2.93	2.89	1.35	1.30	1.33	1.33	1.83
6	.92	.75	1.02	1.90	1.70	2.97	2.94	1.31	1.30	1.35	1.35	1.83
7	.92	.75	1.01	1.90	1.70	3.01	2.99	1.19	1.30	1.35	1.37	1.83
8	.93	.74	1.04	1.91	1.70	3.02	3.11	1.38	1.30	1.47	1.40	1.73
9	.92	.75	1.09	1.90	1.51	3.04	3.35	1.39	1.30	1.24	1.41	1.76
10	.92	.74	1.10	1.90	1.42	3.03	3.36	1.44	1.30	1.23	1.43	1.55
11	.90	.71	1.14	1.86	1.31	2.99	3.47	1.48	1.30	1.42	1.43	1.14
12	.88	.73	1.20	1.63	1.42	3.03	3.68	1.49	1.30	1.21	1.43	1.86
13	.84	.72	1.12	1.65	1.52	3.11	3.73	1.45	1.30	1.29	1.45	1.63
14	.85	.71	1.81	1.64	1.53	3.11	3.75	1.65	1.30	1.29	1.40	1.21
15	.86	.70	1.87	1.63	1.53	3.11	3.70	1.80	1.30	1.23	1.42	1.95
16	.86	.72	1.92	1.63	1.52	3.11	3.68	1.77	1.06	1.42	1.48	2.42
17	.86	.71	1.95	1.67	1.51	3.10	3.69	1.80	1.06	1.42	1.43	2.36
18	.86	.69	2.04	1.68	1.51	3.00	3.69	1.80	1.06	1.47	1.53	2.40
19	.84	.69	2.09	1.69	1.51	3.01	3.70	1.81	1.06	1.52	1.53	2.41
20	.85	.73	2.15	1.66	1.50	3.06	3.70	1.84	1.06	1.38	1.53	2.41
21	.85	.81	1.55	1.68	1.44	3.06	3.37	1.88	1.18		1.57	2.53
22	.84	.83	1.17	1.73	1.46	3.04	3.35	1.75	1.18	1.51	1.51	2.58
23	.83	.85	1.18	1.76	1.91	3.02	3.60	1.74	1.18	1.46	1.72	2.24
24	.83	.90	1.18	1.83	2.79	3.02	3.63	1.76	1.18	1.45	1.70	2.09
25	.83	.94	1.18	1.83	2.59	3.07	3.63	1.86	1.18	1.45	1.95	2.15
26	.84	.96	1.16	1.88	2.59	3.07	3.54	1.95	1.18	1.42	1.36	2.47
27	.83	.99	1.19	1.98	2.59	3.11	3.57	1.96	1.18	1.37	1.36	2.06
28	.79	1.03	1.29	1.87	2.59	3.11	3.66	1.96	1.18	1.35	1.37	1.50
29	.75	1.07	1.29	1.94	-----	3.11	3.67	1.97	1.18	1.26	1.37	1.83
30	.75	1.10	1.28	1.89	-----	3.10	3.58	1.97	1.18	1.29	1.36	1.83
31	.75	-----	1.30	1.81	-----	3.09	-----	2.06	-----	1.34	1.34	-----
Total	26.80	24.07	41.98	49.75	49.47	93.51	102.96	51.37	36.60	40.77	45.26	58.94
Mean	.86	.80	1.35	1.60	1.77	3.02	3.43	1.66	1.22	1.36	1.46	1.96
Max	.99	1.10	2.15	1.98	2.79	3.11	3.75	2.06	1.30	1.52	1.95	2.58
Min	.75	.69	.99	0	1.31	2.45	2.89	1.19	1.06	1.21	1.33	1.14
Acre-Ft	53	48	83	99	98	185	204	102	73	81	90	117
wtr Year 2015	Total	621.48	Mean	1.71	Max	3.75	Min	0	Inst Max	45.7	Acre-Ft	1230
Cal Year 2014	Total	447.52	Mean	1.23	Max	3.11	Min	.41	Inst Max	11.8	Acre-Ft	888

RUNOFF – DAILY DISCHARGE

Los Angeles County Dept of Public works

USDAY V106 Output 03/16/2016

Summary Report

Site: G44B San Gabriel River Above Whittier Narrows Dam
 USGS #:
 Beginning Date: 10/01/2014
 Ending Date: 09/30/2015

Daily Mean Discharge in Cubic feet/second water Year Oct 2014 to Sep 2015

Day	OCT	NOV	DEC	JAN	FEB	MAR	APR	MAY	JUN	JUL	AUG	SEP
1	0	0	1.11	0	0	0	0	0	0	0	0	0
2	0	0	975	0	0	144	0	0	0	0	0	0
3	0	0	129	0	0	0	0	0	0	0	0	0
4	0	0	100	0	0	0	0	0	0	0	0	0
5	0	0	0	0	0	0	0	0	0	0	0	0
6	0	0	0	0	0	0	0	0	0	0	0	0
7	0	0	0	0	0	0	0	0	0	0	0	0
8	0	0	0	0	0	0	0	0	0	0	0	0
9	0	0	0	0	0	0	0	0	0	0	0	0
10	0	0	0	0	0	0	0	0	0	0	0	0
11	0	0	0	0	0	0	0	0	0	0	0	0
12	0	0	958	0	0	0	0	0	0	0	0	0
13	0	0	0	0	0	0	0	0	0	0	0	0
14	0	0	0	0	0	0	0	0	0	0	0	0
15	0	0	0	0	0	0	0	32.1	0	0	0	764
16	0	0	0	0	0	0	0	0	0	0	0	0
17	0	0	144	0	0	0	0	0	0	0	0	0
18	0	0	0	0	0	0	0	0	0	0	0	0
19	0	0	0	0	0	0	0	0	0	155	0	0
20	0	0	0	0	0	0	0	0	0	0	0	0
21	0	0	0	0	0	0	0	0	0	0	0	0
22	0	0	0	0	16.6	0	0	0	0	0	0	0
23	0	0	0	0	201	0	0	0	0	0	0	0
24	0	0	0	0	0	0	0	0	0	0	0	0
25	0	0	0	0	0	0	0	0	0	0	0	0
26	0	0	0	0	0	0	0	0	0	0	0	0
27	0	0	0	0	0	0	0	0	0	0	0	0
28	0	0	0	0	0	0	0	0	0	0	0	0
29	0	0	0	0	-----	0	0	0	0	0	0	0
30	0	83.4	0	0	-----	0	0	0	0	0	0	0
31	0	-----	0	0	-----	0	-----	0	-----	0	0	-----
Total	0	83.4	2307.11	0	217.6	144	0	32.1	0	155	0	764
Mean	0	2.78	74.4	0	7.77	4.65	0	1.04	0	5.00	0	25.5
Max	0	83.4	975	0	201	144	0	32.1	0	155	0	764
Min	0	0	0	0	0	0	0	0	0	0	0	0
Acre-Ft	0	165	4580	0	432	286	0	64	0	307	0	1520
Wtr Year 2015	Total	3703.21	Mean	10.1	Max	975	Min	0	Inst Max	6750	Acre-Ft	7350
Cal Year 2014	Total	4491.35	Mean	12.3	Max	1640	Min	0	Inst Max	7320	Acre-Ft	8910

RUNOFF – DAILY DISCHARGE

Los Angeles County Dept of Public works

USDAY V106 Output 03/16/2016

Summary Report

Site: U8 San Gabriel River Below Morris Dam
 USGS #:
 Beginning Date: 10/01/2014
 Ending Date: 09/30/2015

Daily Mean Discharge in Cubic feet/second Water Year Oct 2014 to Sep 2015

Day	OCT	NOV	DEC	JAN	FEB	MAR	APR	MAY	JUN	JUL	AUG	SEP
1	24.0	60.0	58.6	57.5	30.8	59.7	57.5	65.4	60.9	.99	0	0
2	24.0	59.7	24.3	57.5	52.8	59.8	57.5	60.9	60.9	1.26	0	0
3	23.9	59.7	1.41	57.5	59.7	59.7	57.5	60.9	60.9	1.31	0	0
4	23.9	59.0	.88	57.5	59.6	59.7	57.5	60.9	61.6	1.30	0	0
5	23.8	58.6	34.7	57.5	59.4	59.7	57.5	60.5	61.6	1.33	0	0
6	23.8	58.3	57.1	57.5	59.7	59.0	57.5	59.7	62.0	1.27	0	0
7	23.8	59.3	57.4	57.5	59.7	58.6	58.7	59.7	62.0	1.24	0	0
8	23.8	59.7	57.5	56.9	59.7	58.6	60.4	59.7	61.8	1.27	0	0
9	24.0	59.7	57.8	56.4	59.7	58.6	59.7	59.7	62.0	1.16	0	0
10	55.5	59.7	57.5	56.6	59.7	58.6	59.7	59.8	61.6	1.12	0	32.5
11	86.5	59.7	57.5	57.8	59.7	58.1	59.7	59.7	60.9	1.12	0	54.5
12	86.5	59.7	60.2	57.5	59.7	80.0	59.8	59.8	60.9	1.12	0	38.3
13	86.6	59.7	58.4	56.4	59.7	57.9	59.7	59.7	60.9	1.12	0	38.4
14	86.5	59.7	57.5	56.4	59.7	57.5	67.4	60.3	60.9	1.14	0	38.4
15	86.7	59.7	57.5	56.4	59.7	57.5	60.2	60.5	60.9	1.15	0	40.3
16	86.5	59.7	58.0	56.4	59.7	57.5	60.5	60.8	60.9	1.13	0	32.7
17	62.8	59.7	59.6	56.4	59.7	57.5	60.9	60.9	60.9	1.13	0	30.5
18	23.7	59.7	58.6	56.4	59.7	57.5	60.9	60.9	60.0	1.22	0	30.5
19	23.3	59.7	58.6	56.4	59.0	57.5	60.9	60.9	59.4	1.26	0	30.0
20	23.3	59.7	58.6	56.4	58.6	57.5	61.2	60.9	59.7	1.14	0	30.0
21	23.3	60.2	58.6	56.4	58.6	57.5	62.0	60.9	59.8	.27	0	30.1
22	23.3	59.7	58.6	56.4	57.9	57.5	62.0	60.9	59.4	0	0	30.6
23	23.3	59.7	58.6	56.4	59.5	57.5	62.1	60.9	57.9	0	0	30.8
24	23.3	56.8	58.6	72.6	59.7	57.5	62.0	60.9	57.5	0	0	30.8
25	23.3	58.0	58.1	55.2	59.7	57.5	62.0	61.1	57.5	0	0	30.8
26	23.3	55.7	57.8	30.8	59.7	57.5	62.0	60.3	57.7	0	0	30.8
27	52.1	55.3	57.5	30.8	59.7	57.5	61.6	60.1	58.6	0	0	30.8
28	60.4	57.8	57.5	30.8	59.7	57.5	60.3	60.8	58.0	0	0	30.8
29	59.7	57.5	57.5	30.8	-----	57.5	59.7	60.9	30.1	0	0	30.7
30	59.7	58.0	57.6	30.8	-----	57.5	59.7	60.9	16.0	0	0	30.7
31	59.7	-----	57.5	30.8	-----	57.5	-----	60.9	-----	0	0	-----
Total	1354.3	1769.4	1629.59	1620.7	1630.5	1823.0	1808.1	1880.2	1733.2	24.05	0	703.0
Mean	43.7	59.0	52.6	52.3	58.2	58.8	60.3	60.7	57.8	.78	0	23.4
Max	86.7	60.2	60.2	72.6	59.7	80.0	67.4	65.4	62.0	1.33	0	54.5
Min	23.3	55.3	.88	30.8	30.8	57.5	57.5	59.7	16.0	0	0	0
Acre-Ft	2690	3510	3230	3210	3230	3620	3590	3730	3440	48	0	1390
wtr Year 2015	Total	15976.04	Mean	43.8	Max	86.7	Min	0	Inst Max	982	Acre-Ft	31690
Cal Year 2014	Total	12233.63	Mean	33.5	Max	86.7	Min	.22	Inst Max	87.9	Acre-Ft	24270

RUNOFF – DAILY DISCHARGE

Los Angeles County Dept of Public works

USDAY V106 Output 03/16/2016

Summary Report

Site: F251 San Gabriel River - West Fork at Toe of Cogswell Dam
 USGS #:
 Beginning Date: 10/01/2014
 Ending Date: 09/30/2015

Daily Mean Discharge in Cubic feet/second water Year Oct 2014 to Sep 2015

Day	OCT	NOV	DEC	JAN	FEB	MAR	APR	MAY	JUN	JUL	AUG	SEP
1	1.11	.92	.90	1.47	1.73	1.87	1.60	1.47	1.47	1.47	1.73	1.86
2	1.09	.91	.94	1.48	1.73	1.88	1.57	1.41	1.47	1.46	1.72	1.81
3	1.09	.91	.92	1.49	1.73	1.86	1.56	1.35	1.47	1.35	1.73	1.78
4	1.10	.91	.92	1.50	1.73	1.86	1.57	1.35	1.48	1.36	1.72	1.80
5	1.07	.91	.93	1.52	1.73	1.86	1.57	1.35	1.54	1.35	1.73	1.86
6	.92	.91	.94	1.53	1.73	1.80	1.60	1.35	1.55	1.35	1.63	1.80
7	.91	.91	.95	1.54	1.73	1.74	1.69	1.39	1.60	1.38	1.55	1.78
8	.91	.91	.95	1.55	1.73	1.80	1.70	1.84	1.57	1.44	1.60	1.77
9	.91	.91	.96	1.67	1.73	1.68	1.60	1.79	1.60	1.47	1.58	1.75
10	.91	.91	.97	1.74	1.73	1.60	1.60	1.67	1.62	1.46	1.70	1.73
11	.91	.91	.98	1.83	1.68	1.60	1.60	1.60	1.62	1.47	1.73	1.77
12	.91	.91	1.12	1.73	1.60	1.60	1.60	1.59	1.61	1.45	1.73	1.85
13	.91	.91	1.21	1.75	1.60	1.60	1.60	1.53	1.67	1.68	1.73	1.80
14	.91	.91	1.23	1.76	1.60	1.60	1.60	1.56	1.61	1.84	1.71	1.80
15	.91	.91	1.24	1.77	1.60	1.60	1.60	1.60	1.55	1.86	1.73	1.85
16	.91	.91	1.33	1.79	1.60	1.60	1.60	1.73	1.51	1.86	1.72	1.82
17	.91	.91	1.35	1.80	1.61	1.60	1.60	1.73	1.47	1.86	1.72	1.83
18	.91	.91	1.35	1.81	1.71	1.63	1.60	1.73	1.47	1.86	1.89	1.83
19	.91	.85	1.35	1.68	1.73	1.69	1.60	1.73	1.21	1.86	1.98	1.79
20	.91	.81	1.35	1.58	1.73	1.66	1.60	1.73	1.39	1.86	1.94	1.72
21	.91	.82	1.35	1.64	1.73	1.60	1.60	1.70	1.41	1.86	1.98	1.66
22	.91	.83	1.35	1.68	1.83	1.60	1.60	1.73	1.35	1.86	1.99	1.66
23	.91	.83	1.36	1.73	1.84	1.60	1.71	1.73	1.52	1.86	1.93	1.60
24	.91	.81	1.37	1.64	1.73	1.60	1.73	1.73	1.31	1.86	1.83	1.77
25	.91	.75	1.39	1.66	1.73	1.60	1.77	1.73	1.28	1.86	1.83	1.86
26	.91	.76	1.40	1.75	1.73	1.60	1.73	1.70	1.28	1.86	1.81	1.86
27	.91	.77	1.41	1.73	1.73	1.60	1.63	1.65	1.35	1.86	1.80	1.79
28	.91	.77	1.42	1.73	1.73	1.60	1.54	1.60	1.35	1.84	1.86	1.81
29	.91	.78	1.43	1.73	-----	1.60	1.47	1.54	1.35	1.81	1.85	1.82
30	.91	.86	1.44	1.73	-----	1.60	1.47	1.49	1.45	1.73	1.84	1.81
31	.92	-----	1.46	1.73	-----	1.60	-----	1.47	-----	1.73	1.86	-----
Total	29.14	26.03	37.27	51.74	47.81	51.73	48.31	49.57	44.13	51.82	55.15	53.64
Mean	.94	.87	1.20	1.67	1.71	1.67	1.61	1.60	1.47	1.67	1.78	1.79
Max	1.11	.92	1.46	1.83	1.84	1.88	1.77	1.84	1.67	1.86	1.99	1.86
Min	.91	.75	.90	1.47	1.60	1.60	1.47	1.35	1.21	1.35	1.55	1.60
Acre-Ft	58	52	74	103	95	103	96	98	88	103	109	106
wtr Year 2015	Total	546.34	Mean	1.50	Max	1.99	Min	.75	Inst Max	1.99	Acre-Ft	1080
Cal Year 2014	Total	464.06	Mean	1.27	Max	2.17	Min	.42	Inst Max	2.26	Acre-Ft	920

RUNOFF – DAILY DISCHARGE

Los Angeles County Dept of Public works

USDAY V106 Output 03/16/2016

Summary Report

Site: F312B San Jose Channel Above Workman Mill Road
 USGS #:
 Beginning Date: 10/01/2014
 Ending Date: 09/30/2015

Daily Mean Discharge in Cubic feet/second Water Year Oct 2014 to Sep 2015

Day	OCT	NOV	DEC	JAN	FEB	MAR	APR	MAY	JUN	JUL	AUG	SEP
1	5.98	262	123	8.84	6.90	65.5	11.3	15.1	15.6	13.3	7.97	9.35
2	6.53	9.59	712	8.05	6.90	137	22.0	18.7	12.9	10.6	12.1	9.08
3	6.51	8.60	307	8.05	6.90	20.8	22.4	19.4	14.6	11.0	10.7	6.53
4	7.76	8.14	132	8.05	6.90	18.0	26.7	17.8	14.7	11.2	5.85	4.65
5	7.13	7.84	21.6	8.61	7.37	17.4	27.4	15.3	14.5	13.0	2.52	9.05
6	6.61	7.77	20.5	8.05	8.05	14.6	26.2	12.5	16.3	9.88	11.6	8.17
7	3.98	7.45	19.4	8.05	8.05	12.1	53.5	56.0	16.8	10.0	3.39	8.91
8	4.27	7.77	19.2	8.05	8.05	13.9	33.6	210	17.8	9.21	3.41	8.71
9	3.96	7.53	18.9	8.05	8.05	15.5	16.7	17.6	15.8	10.1	4.65	7.64
10	8.30	7.22	19.6	13.7	8.05	12.1	15.5	16.3	16.7	7.60	10.9	4.45
11	8.70	6.08	20.5	209	10.6	15.7	22.4	15.3	16.8	12.1	4.45	4.95
12	7.57	6.26	663	10.4	15.7	8.95	22.3	11.7	19.4	11.5	5.77	3.71
13	7.86	5.76	46.5	9.23	14.8	12.1	21.0	13.2	20.2	12.8	5.59	8.26
14	7.47	5.03	35.9	9.20	17.3	12.3	16.0	128	18.8	5.49	10.1	9.48
15	5.30	5.48	8.52	8.55	19.4	12.3	15.4	103	18.4	4.54	6.75	655
16	6.26	5.31	8.63	8.05	16.9	12.0	16.9	23.0	19.4	4.07	18.6	34.0
17	8.33	4.15	292	8.05	14.9	10.9	13.4	21.0	21.4	6.77	13.1	13.4
18	8.28	3.08	13.7	8.05	17.9	11.4	19.7	20.0	14.7	126	10.4	10.7
19	7.59	2.49	12.1	8.05	15.2	7.28	18.2	19.6	13.6	246	4.73	13.6
20	5.96	2.96	11.4	8.05	16.8	5.87	19.3	17.8	13.8	43.5	3.48	12.7
21	6.29	50.7	10.4	8.05	18.0	10.7	17.1	17.1	16.2	13.1	3.74	13.5
22	6.65	6.60	10.4	8.05	116	12.9	15.8	16.4	16.2	16.5	8.44	7.26
23	5.63	6.55	10.4	8.05	157	11.6	16.0	19.5	15.9	14.4	11.8	6.96
24	4.70	5.67	10.4	7.75	23.9	10.6	17.0	20.9	12.0	11.6	10.4	4.62
25	5.24	8.17	10.1	7.25	18.8	8.71	63.8	20.1	8.46	11.7	7.92	8.88
26	7.63	12.3	9.20	51.9	19.2	8.65	24.3	17.1	12.2	11.8	10.9	9.34
27	7.86	16.8	9.20	17.2	19.2	5.05	17.7	17.3	12.0	11.5	8.04	10.7
28	6.92	12.7	9.20	8.05	29.3	7.01	15.3	17.5	15.7	8.57	7.72	9.45
29	6.65	14.8	9.20	7.93	-----	9.76	17.9	13.9	14.0	7.12	6.48	7.28
30	6.06	319	20.3	7.54	-----	8.16	15.0	15.4	13.3	19.9	8.58	5.06
31	10.3	-----	11.0	6.90	-----	6.37	-----	18.7	-----	5.76	9.55	-----
Total	208.28	833.80	2625.25	512.80	636.12	535.21	659.8	965.2	468.16	710.61	249.63	925.39
Mean	6.72	27.8	84.7	16.5	22.7	17.3	22.0	31.1	15.6	22.9	8.05	30.8
Max	10.3	319	712	209	157	137	63.8	210	21.4	246	18.6	655
Min	3.96	2.49	8.52	6.90	6.90	5.05	11.3	11.7	8.46	4.07	2.52	3.71
Acre-Ft	413	1650	5210	1020	1260	1060	1310	1910	929	1410	495	1840
wtr Year 2015	Total	9330.25	Mean	25.6	Max	712	Min	2.49	Inst Max	4850	Acre-Ft	18510
Cal Year 2014	Total	8440.92	Mean	23.1	Max	1100	Min	2.49	Inst Max	3420	Acre-Ft	16740

RUNOFF – DAILY DISCHARGE

Los Angeles County Dept of Public Works

USDAY V106 Output 06/30/2016

Summary Report

Site: F119C Santa Anita Creek Below Santa Anita Dam
 USGS #:
 Beginning Date: 10/01/2014
 Ending Date: 09/30/2015

Daily Mean Discharge in Cubic feet/second Water Year Oct 2014 to Sep 2015

Day	OCT	NOV	DEC	JAN	FEB	MAR	APR	MAY	JUN	JUL	AUG	SEP
1	0	0	0	.06	.02	.02	1.77	0	0	0	0	0
2	0	0	.02	.09	0	.07	.01	0	0	0	0	0
3	0	0	0	.12	.01	.01	0	0	0	0	0	0
4	0	0	.03	.08	.02	.02	0	0	0	0	0	0
5	0	0	0	0	0	.05	0	0	0	0	0	0
6	0	0	0	0	.01	0	.02	0	0	0	0	0
7	0	0	0	0	.02	0	.01	.01	0	0	0	0
8	0	0	0	0	.01	0	0	.01	0	0	0	0
9	0	0	0	0	.01	.01	0	0	0	0	0	0
10	0	0	6.68	.03	9.24	0	0	0	0	0	0	0
11	0	0	3.96	.07	4.91	0	0	0	0	0	0	0
12	0	0	.86	.02	4.31	0	0	.01	0	0	0	0
13	0	0	.02	.03	0	0	0	0	0	0	0	0
14	0	0	.01	.02	0	0	0	.02	0	0	0	0
15	0	0	0	.02	0	0	0	0	0	0	0	0
16	0	0	.03	0	0	0	0	0	0	0	0	0
17	0	0	.07	.04	.02	0	0	0	0	0	0	0
18	0	0	11.7	0	9.23	0	0	0	0	0	0	0
19	0	.60	4.25	0	6.10	0	0	0	0	.31	17.6	0
20	0	0	.01	8.20	0	0	0	0	0	0	15.7	0
21	0	.01	0	3.98	0	0	0	0	0	0	10.5	0
22	0	0	0	.01	.03	0	0	0	0	0	8.37	0
23	0	0	0	.02	.09	0	0	0	0	0	6.40	0
24	0	0	0	0	.01	0	.01	0	0	0	4.75	0
25	0	0	.04	0	0	9.24	0	0	0	0	3.50	0
26	0	0	.11	.03	0	7.14	0	0	0	0	1.48	0
27	0	0	.04	.02	0	7.61	0	0	0	0	0	0
28	0	0	.01	0	.04	8.46	0	0	0	0	0	0
29	0	0	13.9	0	-----	7.54	0	0	0	0	0	0
30	0	.02	11.3	0	-----	5.59	0	0	0	0	0	0
31	0	-----	3.92	.01	-----	5.29	-----	0	-----	0	0	-----
Total	0	0.63	56.96	12.85	34.08	51.05	1.82	0.05	0	0.31	68.30	0
Mean	0	.021	1.84	.41	1.22	1.65	.061	.002	0	.010	2.20	0
Max	0	.60	13.9	8.20	9.24	9.24	1.77	.02	0	.31	17.6	0
Min	0	0	0	0	0	0	0	0	0	0	0	0
Acre-Ft	0	1.2	113	25	68	101	3.6	.10	0	.61	135	0
Wtr Year 2015	Total	226.05	Mean	.62	Max	17.6	Min	0	Inst Max	52.4	Acre-Ft	448
Cal Year 2014	Total	268.41	Mean	.74	Max	13.9	Min	0	Inst Max	52.4	Acre-Ft	532

RUNOFF – DAILY DISCHARGE

Los Angeles County Dept of Public works

USDAY V106 Output 03/16/2016

Summary Report

Site: F260C Santa Anita Wash Below Foothill Boulevard
 USGS #:
 Beginning Date: 10/01/2014
 Ending Date: 09/30/2015

Daily Mean Discharge in Cubic feet/second water Year Oct 2014 to Sep 2015

Day	OCT	NOV	DEC	JAN	FEB	MAR	APR	MAY	JUN	JUL	AUG	SEP
1	0	1.46	.01	0	0	.06	0	0	0	0	0	0
2	0	0	6.03	0	.07	1.05	0	0	0	0	0	0
3	0	.02	2.53	0	.07	.09	0	0	0	0	0	0
4	0	0	.07	0	0	0	0	.04	0	0	0	0
5	0	0	0	.08	0	0	0	.04	0	0	0	0
6	.03	0	0	.07	0	0	.14	0	0	0	0	0
7	0	0	0	0	.14	0	.46	.04	0	0	0	0
8	0	0	.01	0	0	0	0	1.13	0	0	0	0
9	0	0	.18	.34	.12	.14	0	1.22	0	0	0	0
10	0	.02	0	1.92	.03	0	0	1.43	0	0	0	0
11	0	0	0	3.27	0	0	0	.49	0	0	.01	.02
12	0	.01	9.78	1.44	0	0	0	0	0	0	.08	0
13	0	0	0	.86	0	0	.12	.17	0	0	0	0
14	0	0	0	0	0	0	0	3.47	0	0	0	0
15	0	0	0	0	0	0	0	.01	0	0	0	6.86
16	0	0	.50	0	0	.02	0	0	0	0	0	.36
17	0	0	2.59	0	.14	.08	0	0	0	0	0	0
18	0	0	0	0	0	.07	0	0	0	.76	0	0
19	0	0	0	0	0	0	0	0	0	1.99	0	0
20	0	0	0	.02	0	0	.11	0	0	.11	0	0
21	0	.03	0	.12	0	.02	.06	0	0	0	0	0
22	0	0	.03	0	2.69	0	0	0	0	0	0	0
23	0	0	.10	0	1.53	.18	0	0	0	0	0	0
24	0	0	0	0	.11	0	.06	0	0	0	0	0
25	0	0	0	0	.05	0	.32	0	0	0	0	0
26	0	0	0	.36	0	0	0	0	0	0	0	0
27	.03	0	0	.01	.04	0	.13	0	0	0	0	0
28	.01	0	.09	.02	.13	0	0	0	0	.10	0	.03
29	0	0	.01	0	-----	0	0	0	0	0	0	0
30	0	.78	.80	0	-----	.07	0	0	0	0	0	0
31	.52	-----	.01	0	-----	.03	-----	0	-----	0	0	-----
Total	0.59	2.32	22.74	8.51	5.12	1.81	1.40	8.04	0	2.96	0.09	7.27
Mean	.019	.077	.73	.27	.18	.058	.047	.26	0	.095	.003	.24
Max	.52	1.46	9.78	3.27	2.69	1.05	.46	3.47	0	1.99	.08	6.86
Min	0	0	0	0	0	0	0	0	0	0	0	0
Acre-Ft	1.2	4.6	45	17	10	3.6	2.8	16	0	5.9	.18	14
wtr Year 2015	Total	60.85	Mean	.17	Max	9.78	Min	0	Inst Max	581	Acre-Ft	121
Cal Year 2014	Total	55.73	Mean	.15	Max	14.9	Min	0	Inst Max	581	Acre-Ft	111

RUNOFF – DAILY DISCHARGE

Los Angeles County Dept of Public works

USDAY V106 Output 03/16/2016

Summary Report

Site: F193B Santa Anita Wash at Longden Avenue
 USGS #:
 Beginning Date: 10/01/2014
 Ending Date: 09/30/2015

Daily Mean Discharge in Cubic feet/second water Year Oct 2014 to Sep 2015

Day	OCT	NOV	DEC	JAN	FEB	MAR	APR	MAY	JUN	JUL	AUG	SEP
1	.07	9.31	.81	.09	.05	.54	.06	.06	0	.06	0	.05
2	.08	.06	32.0	.05	.19	6.76	.05	.12	0	.12	0	.06
3	.06	.08	11.4	.09	.24	.31	.05	.11	0	.12	.05	.20
4	.07	.14	.80	.04	.11	.05	.06	.14	.05	.12	.11	.13
5	.06	.06	.10	.19	.10	.10	.06	.11	.10	.10	.13	.06
6	.14	.06	.11	.18	.10	.10	.31	.11	.10	.13	.12	.11
7	.10	.07	.05	.05	.52	.11	4.60	.20	.10	.11	.12	.12
8	.07	.06	.15	.05	.11	.11	.11	3.54	.09	.05	.11	.06
9	.18	.06	.53	1.57	.31	.45	.06	4.00	.17	.17	.06	.06
10	.07	.11	.14	5.69	.21	.11	.07	4.43	.09	.10	.11	.07
11	.08	.08	.12	14.8	.05	.11	.19	1.46	.10	.10	.16	.11
12	.08	.10	43.0	2.01	.15	.05	.06	.25	.09	.10	.46	.20
13	.07	.07	.15	1.49	.09	.05	.43	.56	.10	.12	.12	.13
14	.23	.08	.09	.09	.10	.05	.06	17.2	.09	.23	.12	.12
15	.08	.08	.09	.05	.11	.06	.06	.32	.10	.12	.12	32.3
16	.08	.06	1.99	.05	.11	.20	.05	.11	.09	.12	.11	2.48
17	.08	.06	12.1	.05	.36	.23	.06	.05	.09	.13	.12	.06
18	.08	.08	.10	.05	.10	.23	.06	.05	.09	3.93	.11	0
19	.07	.18	.09	.05	.11	.06	0	.11	.11	10.4	.11	0
20	.08	.10	.09	.15	.11	.21	.30	.11	.10	.63	.12	.12
21	.07	1.49	.09	.30	.10	.16	.18	.06	.10	.12	.12	.06
22	.06	.13	.18	.05	15.8	.07	.07	.06	.05	.13	.06	.12
23	.06	.12	.36	.05	9.48	.45	.13	.06	.18	.19	.12	.13
24	.06	.06	.10	.07	.37	.05	.21	.06	.15	.11	.05	.11
25	.08	.13	.05	.05	.09	.06	2.35	.05	.11	.11	.12	.06
26	.07	.12	.05	1.26	.10	.05	.05	.06	.11	.13	.12	.06
27	.22	.06	.04	.36	.22	.12	.36	0	.10	.11	.12	.06
28	.07	.12	.06	.18	.89	.12	.19	.06	.12	.31	.11	.09
29	.06	.13	.04	.06	-----	.06	.13	0	.12	.10	.11	.06
30	.06	5.80	4.39	.07	-----	.20	1.69	.06	.12	.18	.11	.06
31	3.20	-----	.08	.11	-----	.18	-----	.14	-----	0	.11	-----
Total	5.84	19.06	109.35	29.35	30.28	11.41	12.06	33.65	2.82	18.45	3.51	37.25
Mean	.19	.64	3.53	.95	1.08	.37	.40	1.09	.094	.60	.11	1.24
Max	3.20	9.31	43.0	14.8	15.8	6.76	4.60	17.2	.18	10.4	.46	32.3
Min	.06	.06	.04	.04	.05	.05	0	0	0	0	0	0
Acre-Ft	12	38	217	58	60	23	24	67	5.6	37	7.0	74
wtr Year 2015	Total	313.03	Mean	.86	Max	43.0	Min	0	Inst Max	799	Acre-Ft	621
Cal Year 2014	Total	309.37	Mean	.85	Max	70.3	Min	0	Inst Max	799	Acre-Ft	614

RUNOFF – DAILY DISCHARGE

Los Angeles County Dept of Public works

USDAY V106 Output 03/17/2016

Summary Report

Site: F93C Santa Clara River at Capra Road Railroad Crossing
 USGS #:
 Beginning Date: 10/01/2014
 Ending Date: 09/30/2015

Daily Mean Discharge in Cubic feet/second water Year Oct 2014 to Sep 2015

Day	OCT	NOV	DEC	JAN	FEB	MAR	APR	MAY	JUN	JUL	AUG	SEP
1	0	0	0	0	0	0	0	0	0	0	0	0
2	0	0	1.42	0	0	0	0	0	0	0	0	0
3	0	0	0	0	0	0	0	0	0	0	0	0
4	0	0	0	0	0	0	0	0	0	0	0	0
5	0	0	0	0	0	0	0	0	0	0	0	0
6	0	0	0	0	0	0	0	0	0	0	0	0
7	0	0	0	0	0	0	0	0	0	0	0	0
8	0	0	0	0	0	0	0	0	0	0	0	0
9	0	0	0	0	0	0	0	0	0	0	0	4.15
10	0	0	0	0	0	0	0	0	0	0	0	0
11	0	0	0	0	0	0	0	0	0	0	0	0
12	0	0	16.0	0	0	0	0	0	0	0	0	0
13	0	0	.09	0	0	0	0	0	0	0	0	0
14	0	0	0	0	0	0	0	0	0	0	0	0
15	0	0	0	0	0	0	0	0	0	0	0	.13
16	0	0	0	0	0	0	0	0	0	0	0	0
17	0	0	0	0	0	0	0	0	0	0	0	0
18	0	0	0	0	0	0	0	0	0	0	0	0
19	0	0	0	0	0	0	0	0	0	0	0	0
20	0	0	0	0	0	0	0	0	0	0	0	0
21	0	0	0	0	0	0	0	0	0	0	0	0
22	0	0	0	0	0	0	0	0	0	0	0	0
23	0	0	0	0	0	0	0	0	0	0	0	0
24	0	0	0	0	0	0	0	0	0	0	0	0
25	0	0	0	0	0	0	0	0	0	0	0	0
26	0	0	0	0	0	0	0	0	0	0	0	0
27	0	0	0	0	0	0	0	0	0	0	0	0
28	0	0	0	0	0	0	0	0	0	0	0	0
29	0	0	0	0	-----	0	0	0	0	.01	0	0
30	0	0	0	0	-----	0	0	0	0	10.8	0	0
31	0	-----	0	0	-----	0	-----	0	-----	.07	0	-----
Total	0	0	17.51	0	0	0	0	0	0	10.88	0	4.28
Mean	0	0	.56	0	0	0	0	0	0	.35	0	.14
Max	0	0	16.0	0	0	0	0	0	0	10.8	0	4.15
Min	0	0	0	0	0	0	0	0	0	0	0	0
Acre-Ft	0	0	35	0	0	0	0	0	0	22	0	8.5
Wtr Year 2015	Total	32.67	Mean	.090	Max	16.0	Min	0	Inst Max	330	Acre-Ft	65
Cal Year 2014	Total	125.51	Mean	.34	Max	51.0	Min	0	Inst Max	288	Acre-Ft	249

RUNOFF – DAILY DISCHARGE

Los Angeles County Dept of Public works

USDAY V106 Output 03/16/2016

Summary Report

Site: F280 Santa Fe Channel Below Santa Fe Dam
 USGS #:
 Beginning Date: 10/01/2014
 Ending Date: 09/30/2015

Daily Mean Discharge in Cubic feet/second water Year Oct 2014 to Sep 2015

Day	OCT	NOV	DEC	JAN	FEB	MAR	APR	MAY	JUN	JUL	AUG	SEP
1	0	0	0	0	0	0	0	0	0	0	0	0
2	0	0	0	0	0	0	0	0	0	0	0	0
3	0	0	0	0	0	0	0	0	0	0	0	0
4	0	0	0	0	0	0	0	0	0	0	0	0
5	0	0	0	0	0	0	0	0	0	0	0	0
6	0	0	0	0	0	0	0	0	0	0	0	0
7	0	0	0	0	0	0	0	0	0	0	0	0
8	0	0	0	0	0	0	0	0	0	0	0	0
9	0	0	0	0	0	0	0	0	0	0	0	0
10	0	0	0	0	0	0	0	0	0	0	0	0
11	0	0	0	0	0	0	0	0	0	0	0	0
12	0	0	0	0	0	0	0	0	0	0	0	0
13	0	0	0	0	0	0	0	0	0	0	0	0
14	0	0	0	0	0	0	0	0	0	0	0	0
15	0	0	0	0	0	0	0	0	0	0	0	0
16	0	0	0	0	0	0	0	0	0	0	0	0
17	0	0	0	0	0	0	0	0	0	0	0	0
18	0	0	0	0	0	0	0	0	0	0	0	0
19	0	0	0	0	0	0	0	0	0	0	0	0
20	0	0	0	0	0	0	0	0	0	0	0	0
21	0	0	0	0	0	0	0	0	0	0	0	0
22	0	0	0	0	0	0	0	0	0	0	0	0
23	0	0	0	0	0	0	0	0	0	0	0	0
24	0	0	0	0	0	0	0	0	0	0	0	0
25	0	0	0	0	0	0	0	0	0	0	0	0
26	0	0	0	0	0	0	0	0	0	0	0	0
27	0	0	0	0	0	0	0	0	0	0	0	0
28	0	0	0	0	0	0	0	0	0	0	0	0
29	0	0	0	0	-----	0	0	0	0	0	0	0
30	0	0	0	0	-----	0	0	0	0	0	0	0
31	0	-----	0	0	-----	0	-----	0	-----	0	0	-----
Total	0	0	0	0	0	0	0	0	0	0	0	0
Mean	0	0	0	0	0	0	0	0	0	0	0	0
Max	0	0	0	0	0	0	0	0	0	0	0	0
Min	0	0	0	0	0	0	0	0	0	0	0	0
Acre-Ft	0	0	0	0	0	0	0	0	0	0	0	0
wtr Year 2015	Total	0	Mean	0	Max	0	Min	0	Inst Max	0	Acre-Ft	0
Cal Year 2014	Total	0	Mean	0	Max	0	Min	0	Inst Max	0	Acre-Ft	0

RUNOFF – DAILY DISCHARGE

Los Angeles County Dept of Public works

USDAY V106 Output 03/16/2016

Summary Report

Site: F125 Santiago Canyon Creek Above Littlerock Creek
 USGS #:
 Beginning Date: 10/01/2014
 Ending Date: 09/30/2015

Daily Mean Discharge in Cubic feet/second water Year Oct 2014 to Sep 2015

Day	OCT	NOV	DEC	JAN	FEB	MAR	APR	MAY	JUN	JUL	AUG	SEP
1	0	0	0	0	0	0	0	0	0	0	0	0
2	0	0	0	0	0	0	0	0	0	0	0	0
3	0	0	0	0	0	0	0	0	0	0	0	0
4	0	0	0	0	0	0	0	0	0	0	0	0
5	0	0	0	0	0	0	0	0	0	0	0	0
6	0	0	0	0	0	0	0	0	0	0	0	0
7	0	0	0	0	0	0	0	0	0	0	0	0
8	0	0	0	0	0	0	0	0	0	0	0	0
9	0	0	0	0	0	0	0	0	0	0	0	0
10	0	0	0	0	0	0	0	0	0	0	0	0
11	0	0	0	0	0	0	0	0	0	0	0	0
12	0	0	0	0	0	0	0	0	0	0	0	0
13	0	0	0	0	0	0	0	0	0	0	0	0
14	0	0	0	0	0	0	0	0	0	0	0	0
15	0	0	0	0	0	0	0	0	0	0	0	0
16	0	0	0	0	0	0	0	0	0	0	0	0
17	0	0	0	0	0	0	0	0	0	0	0	0
18	0	0	0	0	0	0	0	0	0	0	0	0
19	0	0	0	0	0	0	0	0	0	0	0	0
20	0	0	0	0	0	0	0	0	0	0	0	0
21	0	0	0	0	0	0	0	0	0	0	0	0
22	0	0	0	0	0	0	0	0	0	0	0	0
23	0	0	0	0	0	0	0	0	0	0	0	0
24	0	0	0	0	0	0	0	0	0	0	0	0
25	0	0	0	0	0	0	0	0	0	0	0	0
26	0	0	0	0	0	0	0	0	0	0	0	0
27	0	0	0	0	0	0	0	0	0	0	0	0
28	0	0	0	0	0	0	0	0	0	0	0	0
29	0	0	0	0	-----	0	0	0	0	0	0	0
30	0	0	0	0	-----	0	0	0	0	0	0	0
31	0	-----	0	0	-----	0	-----	0	-----	0	0	-----
Total	0	0	0	0	0	0	0	0	0	0	0	0
Mean	0	0	0	0	0	0	0	0	0	0	0	0
Max	0	0	0	0	0	0	0	0	0	0	0	0
Min	0	0	0	0	0	0	0	0	0	0	0	0
Acre-Ft	0	0	0	0	0	0	0	0	0	0	0	0
wtr Year 2015	Total	0	Mean	0	Max	0	Min	0	Inst Max	0	Acre-Ft	0
Cal Year 2014	Total	71.70	Mean	.20	Max	22.8	Min	0	Inst Max	37.6	Acre-Ft	142

RUNOFF – DAILY DISCHARGE

Los Angeles County Dept of Public works

USDAY V106 Output 03/16/2016

Summary Report

Site: F278 Sawpit Creek Below Sawpit Dam
 USGS #:
 Beginning Date: 10/01/2014
 Ending Date: 09/30/2015

Daily Mean Discharge in Cubic feet/second water Year Oct 2014 to Sep 2015

Day	OCT	NOV	DEC	JAN	FEB	MAR	APR	MAY	JUN	JUL	AUG	SEP
1	.36	.59	.61	1.10	1.00	1.19	.72	1.30	.76	.45	.68	.46
2	.36	.61	1.38	1.10	1.03	1.30	.73	1.22	.78	.45	.63	.51
3	.35	.63	1.43	1.09	1.03	1.25	.70	1.24	.81	.45	.63	.51
4	.36	.59	1.26	1.03	1.00	1.19	.68	1.41	.89	.48	.63	.52
5	.36	.55	1.08	1.00	1.02	1.20	.70	1.60	.88	.49	.62	.53
6	.36	.55	1.05	.96	1.02	1.15	.72	1.81	.85	.57	.57	.53
7	.36	.57	.95	.96	1.04	1.06	.79	1.85	.74	.61	.56	.51
8	.36	.54	.86	.96	1.11	1.05	.86	2.47	.67	.63	.53	.50
9	.36	.54	.84	.93	1.10	1.01	.81	2.40	.64	.63	.54	.51
10	.36	.60	.90	.91	1.10	.96	.79	2.17	.69	.63	.54	.51
11	.36	.63	.99	1.04	1.05	.96	.79	1.92	.70	.63	.54	.48
12	.36	.62	2.99	1.00	1.00	.91	.83	1.91	.74	.63	.54	.46
13	.36	.63	1.98	1.00	1.01	.86	.89	1.96	.78	.63	.54	.47
14	.36	.63	1.72	1.00	1.05	.85	1.08	2.78	.77	.53	.54	.45
15	.37	.63	1.55	1.00	1.01	.85	1.14	1.14	.72	.54	.54	.67
16	.37	.64	1.49	1.00	.95	.79	1.18	.99	.64	.54	.54	.56
17	.42	.66	2.02	.98	.97	.73	1.16	.93	.62	.49	.54	.46
18	.44	.63	1.64	.93	.96	.73	1.21	.90	.58	.47	.48	.52
19	.45	.63	1.51	.90	.93	.75	1.24	.90	.56	.61	.54	.63
20	.45	.63	1.36	.98	.93	.73	1.24	.87	.54	.83	.54	.68
21		.63	1.29	.97	.99	.74	1.46	.90	.54	.87	.52	.74
22	.45	.65	1.26	1.00	1.28	.77	1.61	.91	.54	.89	.56	.81
23	.45	.67	1.15	1.00	1.61	.80	1.70	.99	.54	.85	.55	.81
24	.46	.63	1.10	1.00	1.38	.81	1.86	1.00	.54	.84	.52	.79
25	.53	.63	1.09	1.00	1.24	.79	1.98	1.00	.48	.77	.51	.79
26	.54	.61	1.09	.97	1.17	.76	1.79	.99	.45	.76	.49	.76
27	.54	.59	1.10	.95	1.19	.70	1.67	.94	.45	.74	.50	.76
28	.54	.57	1.08	.99	1.17	.68	1.58	.86	.45	.72	.48	.76
29	.53	.57	1.09	.94	-----	.70	1.41	.82	.45	.72	.48	.78
30	.54	.65	1.09	1.00	-----	.71	1.39	.77	.46	.71	.52	.74
31	.55	-----	1.10	1.00	-----	.71	-----	.77	-----	.71	.49	-----
Total	12.66	18.30	40.05	30.69	30.34	27.69	34.71	41.72	19.26	19.87	16.89	18.21
Mean	.42	.61	1.29	.99	1.08	.89	1.16	1.35	.64	.64	.54	.61
Max	.55	.67	2.99	1.10	1.61	1.30	1.98	2.78	.89	.89	.68	.81
Min	.35	.54	.61	.90	.93	.68	.68	.77	.45	.45	.48	.45
Acre-Ft	25	36	79	61	60	55	69	83	38	39	34	36
wtr Year 2015	Total	310.39	Mean	.85	Max	2.99	Min	.35	Inst Max	5.37	Acre-Ft	616
Cal Year 2014	Total	406.20	Mean	1.12	Max	6.10	Min	.27	Inst Max	10.0	Acre-Ft	806

RUNOFF – DAILY DISCHARGE

Los Angeles County Dept of Public works

USDAY V106 Output 03/16/2016

Summary Report

Site: F194B Sawpit Wash Below Live Oak Avenue
 USGS #:
 Beginning Date: 10/01/2014
 Ending Date: 09/30/2015

Daily Mean Discharge in Cubic feet/second Water Year Oct 2014 to Sep 2015

Day	OCT	NOV	DEC	JAN	FEB	MAR	APR	MAY	JUN	JUL	AUG	SEP
1	.11	20.6	.58	.29	.32	.76	.09	.05	.02	.06	.04	.03
2	.08	.19	75.4	.29	.34	9.29	.06	.03	.05	.04	.05	.03
3	.06	.18	13.9	.28	.36	.33	.08	.05	.06	.03	.02	.02
4	.05	.18	1.42	.30	.32	.31	.06	.06	.05	.06	.03	.01
5	.05	.15	.30	.28	.31	.28	.07	.06	.05	.10	.03	.04
6	.08	.16	.30	.29	.32	.30	.06	.08	.03	.12	.03	.04
7	.10	.15	.28	.28	.44	.27	5.70	.45	.02	.07	.05	.02
8	.10	.15	.27	.29	.34	.28	.16	1.40	.03	.11	.01	.02
9	.10	.16	.27	.29	.33	.28	.11	.09	.07	.10	.03	.09
10	.13	.18	.27	3.47	.31	.29	.09	.10	.05	.05	.02	.03
11	.09	.19	.26	16.1	.31	.29	.07	.10	.08	.06	.03	.03
12	.10	.19	114	.35	.29	.30	.09	.07	.05	.11	.01	.05
13	.11	.20	.54	.32	.30	.28	.06	.12	.04	.06	.02	.06
14	.13	.21	.40	.32	.30	.26	.08	32.8	.03	.04	.02	.04
15	.14	.21	.40	.32	.34	.25	.06	.27	.02	.04	.05	80.2
16	.12	.21	.50	.32	.33	.25	.05	.06	.03	.05	.01	1.97
17	.16	.20	20.0	.32	.31	.41	.06	.06	.06	.05	.03	.07
18	.13	.15	.40	.32	.32	.33	.05	.03	.02	1.99	.03	.06
19	.13	.05	.40	.32	.31	.31	.06	.02	.02	43.9	.06	.09
20	.17	.06	.40	.32	.30	.27	.08	.04	.01	.26	.04	.09
21	.15	.41	.40	.32	.30	.26	.10	.02	.05	.12	.06	.12
22	.14	.11	.39	.32	23.1	.28	.10	.05	.04	.07	.05	.11
23	.14	.09	.36	.32	14.5	.28	.10	.03	.04	.07	.04	.08
24	.13	.09	.36	.32	.39	.19	.10	.06	.01	.06	.02	.10
25	.13	.09	.34	.32	.32	.08	3.53	.05	.02	.02	.06	.08
26	.14	.07	.32	1.32	.33	.08	.12	.07	.01	.04	.07	.08
27	.15	.10	.33	.43	.36	.07	.07	.05	.02	.02	.04	.14
28	.16	.08	.32	.32	.68	.10	.06	.03	.02	.01	.02	.07
29	.15	.06	.32	.33	-----	.10	.06	.03	.03	.03	.04	.06
30	.14	6.02	5.39	.34	-----	.11	.05	.03	.06	.15	.04	.11
31	2.46	-----	.33	.32	-----	.09	-----	.01	-----	.04	.01	-----
Total	6.03	30.89	239.15	29.73	46.48	16.98	11.43	36.37	1.09	47.93	1.06	83.94
Mean	.19	1.03	7.71	.96	1.66	.55	.38	1.17	.036	1.55	.034	2.80
Max	2.46	20.6	114	16.1	23.1	9.29	5.70	32.8	.08	43.9	.07	80.2
Min	.05	.05	.26	.28	.29	.07	.05	.01	.01	.01	.01	.01
Acre-Ft	12	61	474	59	92	34	23	72	2.2	95	2.1	166
wtr Year 2015	Total	551.08	Mean	1.51	Max	114	Min	.01	Inst Max	2410	Acre-Ft	1090
Cal Year 2014	Total	577.52	Mean	1.58	Max	141	Min	.04	Inst Max	2410	Acre-Ft	1150

RUNOFF – DAILY DISCHARGE

Los Angeles County Dept of Public works

USDAY V106 Output 03/16/2016

Summary Report

Site: F32 Thompson Creek Below Dam
 USGS #:
 Beginning Date: 10/01/2014
 Ending Date: 09/30/2015

Daily Mean Discharge in Cubic feet/second water Year Oct 2014 to Sep 2015

Day	OCT	NOV	DEC	JAN	FEB	MAR	APR	MAY	JUN	JUL	AUG	SEP
1	0	0	0	0	0	0	0	0	0	0	0	0
2	0	0	0	0	0	0	0	0	0	0	0	0
3	0	0	.08	0	0	0	0	0	0	0	0	0
4	0	0	.19	0	0	0	0	0	0	0	0	0
5	0	0	.13	0	0	0	0	0	0	0	0	0
6	0	0	.13	0	0	0	0	0	0	0	0	0
7	0	0	.04	0	0	0	0	0	0	0	0	0
8	0	0	0	0	0	0	0	0	0	0	0	0
9	0	0	0	0	0	0	0	0	0	0	0	0
10	0	0	0	0	0	0	0	0	0	0	0	0
11	0	0	0	0	0	0	0	0	0	0	0	0
12	0	0	.24	0	0	0	0	0	0	0	0	0
13	0	0	.13	0	0	0	0	0	0	0	0	0
14	0	0	.13	0	0	0	0	0	0	0	0	0
15	0	0	.05	0	0	0	0	0	0	0	0	0
16	0	0	0	0	0	0	0	0	0	0	0	0
17	0	0	.24	0	0	0	0	0	0	0	0	0
18	0	0	.13	0	0	0	0	0	0	0	0	0
19	0	0	.13	0	0	0	0	0	0	0	0	0
20	0	0	.11	0	0	0	0	0	0	0	0	0
21	0	0	0	0	0	0	0	0	0	0	0	0
22	0	0	0	0	0	0	0	0	0	0	0	0
23	0	0	0	0	0	0	0	0	0	0	0	0
24	0	0	0	0	0	0	0	0	0	0	0	0
25	0	0	0	0	0	0	0	0	0	0	0	0
26	0	0	0	0	0	0	0	0	0	0	0	0
27	0	0	0	0	0	0	0	0	0	0	0	0
28	0	0	0	0	0	0	0	0	0	0	0	0
29	0	0	0	0	-----	0	0	0	0	0	0	0
30	0	0	0	0	-----	0	0	0	0	0	0	0
31	0	-----	0	0	-----	0	-----	0	-----	0	0	-----
Total	0	0	1.73	0	0	0	0	0	0	0	0	0
Mean	0	0	.056	0	0	0	0	0	0	0	0	0
Max	0	0	.24	0	0	0	0	0	0	0	0	0
Min	0	0	0	0	0	0	0	0	0	0	0	0
Acre-Ft	0	0	3.4	0	0	0	0	0	0	0	0	0
Wtr Year 2015	Total	1.73	Mean	.005	Max	.24	Min	0	Inst Max	.39	Acre-Ft	3.4
Cal Year 2014	Total	1.73	Mean	.005	Max	.24	Min	0	Inst Max	.39	Acre-Ft	3.4

RUNOFF – DAILY DISCHARGE

Los Angeles County Dept of Public works

USDAY V106 Output 03/17/2016

Summary Report

Site: F54C Topanga Creek Above Mouth of Canyon
 USGS #:
 Beginning Date: 10/01/2014
 Ending Date: 09/30/2015

Daily Mean Discharge in Cubic feet/second water Year Oct 2014 to Sep 2015

Day	OCT	NOV	DEC	JAN	FEB	MAR	APR	MAY	JUN	JUL	AUG	SEP
1	.22	.37	7.90	2.02	.47	3.63	0	0	0	0	0	0
2	.22	.45	24.6	2.02	.44	3.31	0	0	0	0	0	0
3	.21	.40	29.0	2.24	.43	1.21	0	0	0	0	0	0
4	.21	.35	8.69	2.85	.42	.64	0	0	0	0	0	0
5	.18	.32	3.57	2.42	.42	.47	0	0	0	0	0	0
6	.16	.29	2.50	2.28	.40	.40	0	0	0	0	0	0
7	.15	.28	2.05	2.28	.40	.38	.09	0	0	0	0	0
8	.15	.27	1.72	2.28	.43	.35	.16	0	0	0	0	0
9	.21	.27	1.54	2.28	.44	.33	.09	0	0	0	0	0
10	.26	.30	1.43	3.49	.43	.33	0	0	0	0	0	0
11	.32	.33	1.45	24.0	.40	.31	0	0	0	0	0	0
12	.33	.35	37.4	7.30	.38	.28	0	0	0	0	0	0
13	.33	.36	8.31	5.59	.36	.26	0	0	0	0	0	0
14	.35	.36	4.65	4.79	.36	.23	0	.22	0	0	0	0
15	.35	.36	3.45	4.28	.36	.23	0	.80	0	0	0	.54
16	.36	.36	5.39	4.04	.36	.23	0	.16	0	0	0	.11
17	.36	.35	8.16	3.71	.36	.23	0	.01	0	0	0	0
18	.36	.33	5.03	3.39	.34	.25	0	0	0	.11	0	0
19	.36	.32	4.00	3.17	.33	.26	0	0	0	.32	0	0
20	.36	.33	3.51	3.17	.33	.26	0	0	0	.06	0	0
21	.37	.33	3.18	3.05	.33	.23	0	0	0	0	0	0
22	.37	.36	2.89	2.75	.41	.23	0	0	0	0	0	0
23	.35	.35	2.62	2.56	.76	.22	0	0	0	0	0	0
24	.32	.33	2.41	2.45	.45	.20	0	0	0	0	0	0
25	.27	.32	2.23	2.41	.35	.20	0	0	0	0	0	0
26	.27	.31	2.08	2.50	.33	.12	0	0	0	0	0	0
27	.27	.31	2.00	3.29	.90	.08	0	0	0	0	0	0
28	.27	.33	1.96	3.21	.37	.02	0	0	0	0	0	0
29	.27	.33	2.07	.82	-----	0	0	0	0	0	0	0
30	.27	8.45	2.19	.50	-----	0	0	0	0	0	0	0
31	.29	-----	2.12	.50	-----	0	-----	0	-----	0	0	-----
Total	8.77	18.17	190.10	111.64	11.76	14.89	0.34	1.19	0	0.49	0	0.65
Mean	.28	.61	6.13	3.60	.42	.48	.011	.038	0	.016	0	.022
Max	.37	8.45	37.4	24.0	.90	3.63	.16	.80	0	.32	0	.54
Min	.15	.27	1.43	.50	.33	0	0	0	0	0	0	0
Acre-Ft	17	36	377	221	23	30	.67	2.4	0	.97	0	1.3
wtr Year 2015	Total	358.00	Mean	.98	Max	37.4	Min	0	Inst Max	167	Acre-Ft	710
Cal Year 2014	Total	425.26	Mean	1.17	Max	87.2	Min	.08	Inst Max	316	Acre-Ft	843

RUNOFF – DAILY DISCHARGE

Los Angeles County Dept of Public Works

USDAY V106 Output 03/17/2016

Summary Report

Site: F252 Verdugo Wash At Estelle Avenue
 USGS #:
 Beginning Date: 10/01/2014
 Ending Date: 09/30/2015

Daily Mean Discharge in Cubic feet/second Water Year Oct 2014 to Sep 2015

Day	OCT	NOV	DEC	JAN	FEB	MAR	APR	MAY	JUN	JUL	AUG	SEP
1	1.97	27.1	3.78	2.58	.87	16.9	2.01	1.46	1.69	1.33	1.63	1.08
2	1.80	1.02	85.1	2.30	.91	25.9	2.08	1.46	1.79	1.26	1.63	1.01
3	1.95	.79	17.7	1.80	.96	4.71	2.01	1.50	1.80	1.28	2.83	1.03
4	1.98	.66	3.46	1.52	1.01	1.42	2.33	2.01	2.20	1.38	3.15	1.15
5	2.17	.43	1.81	1.48	1.01	1.14	2.59	1.98	1.91	1.56	2.91	1.18
6	2.12	.48	1.46	1.50	1.01	.85	2.56	2.02	1.97	1.46	2.91	1.16
7	2.84	1.20	1.23	1.58	4.16	.71	6.97	6.56	1.93	1.46	3.21	1.16
8	2.11	1.01	1.25	1.91	2.86	.67	2.05	5.95	1.95	1.64	3.21	1.32
9	2.03	.69	1.92	2.13	1.82	.74	1.09	1.77	2.18	1.97	3.09	1.35
10	1.80	.50	2.58	14.9	1.46	.72	1.46	1.61	2.27	1.84	2.35	1.34
11	2.23	.34	2.21	18.6	1.46	1.89	1.20	1.54	2.05	1.93	1.98	.96
12	2.16	.32	223	2.29	1.46	.84	1.14	2.10	1.78	2.01	1.98	.40
13	2.19	1.75	2.85	1.79	1.81	.63	1.17	2.37	2.31	2.10	1.76	.06
14	2.34	.63	1.71	1.40	2.06	.63	1.32	47.3	2.22	2.22	1.65	0
15	1.98	.63	1.64	1.41	1.65	.63	1.46	3.96	2.22	2.16	1.98	352
16	1.98	.63	14.3	1.26	1.46	.82	1.25	.93	2.16	2.18	1.98	200
17	2.04	.63	68.6	1.19	1.55	2.33	1.02	.91	2.01	1.95	1.98	97.0
18	2.16	.78	2.46	1.12	1.46	1.71	.90	1.02	2.12	14.6	1.75	48.7
19	2.18	1.55	2.17	1.05	1.82	3.76	.89	.89	1.97	69.5	1.07	32.4
20	2.18	1.03	2.21	.99	1.54	1.59	.91	1.91	2.09	4.66	1.41	19.8
21	2.22	.87	1.98	.93	1.01	1.46	1.42	1.43	2.24	1.62	1.18	10.9
22	2.23	.64	1.88	.86	14.8	1.46	1.82	1.43	2.17	2.02	1.10	5.12
23	2.20	.41	2.01	.77	12.4	1.83	1.78	1.49	2.01	1.55	1.01	1.78
24	2.26	4.61	1.89	1.06	6.71	1.26	1.61	1.56	1.85	1.21	1.01	1.14
25	2.23	3.15	1.37	1.14	1.23	1.01	11.3	1.44	2.11	1.25	1.01	.83
26	2.27	2.08	1.44	4.81	1.01	1.43	2.62	1.72	1.98	1.18	1.06	.59
27	2.30	1.63	1.48	2.48	1.01	1.58	1.67	1.49	2.29	1.02	1.11	.54
28	2.32	1.61	1.37	1.56	2.59	1.63	1.51	1.37	2.10	1.23	.93	.50
29	2.30	1.59	1.41	1.62	-----	1.60	1.49	1.40	2.02	1.60	1.10	.30
30	2.43	14.6	2.71	4.41	-----	1.46	1.51	1.49	1.75	1.77	1.19	.19
31	5.53	-----	3.50	1.33	-----	1.58	-----	1.86	-----	1.46	1.14	-----
Total	70.50	73.36	462.48	83.77	73.10	84.89	63.14	105.93	61.14	134.40	56.30	784.99
Mean	2.27	2.45	14.9	2.70	2.61	2.74	2.10	3.42	2.04	4.34	1.82	26.2
Max	5.53	27.1	223	18.6	14.8	25.9	11.3	47.3	2.31	69.5	3.21	352
Min	1.80	.32	1.23	.77	.87	.63	.89	.89	1.69	1.02	.93	0
Acre-Ft	140	146	917	166	145	168	125	210	121	267	112	1560
wtr Year 2015	Total	2054.00	Mean	5.63	Max	352	Min	0	Inst Max	1920	Acre-Ft	4070
Cal Year 2014	Total	1780.19	Mean	4.88	Max	370	Min	.32	Inst Max	2190	Acre-Ft	3530

RUNOFF – DAILY DISCHARGE

Los Angeles County Dept of Public Works

USDAY V106 Output 03/17/2016

Summary Report

Site: F304 walnut Creek at Puente Avenue
 USGS #:
 Beginning Date: 10/01/2014
 Ending Date: 09/30/2015

Daily Mean Discharge in Cubic feet/second Water Year Oct 2014 to Sep 2015

Day	OCT	NOV	DEC	JAN	FEB	MAR	APR	MAY	JUN	JUL	AUG	SEP
1	.23	30.3	5.26	.38	.05	8.46	.14	.23	.23	.34	.12	.05
2	.23	.09	234	.30	.09	33.6	.09	.23	.23	.36	.12	.04
3	.29	.18	52.9	.23	.08	.33	.04	.23	.19	.23	.12	.04
4	.43	.08	9.40	.25	.05	.12	.06	.19	.19	.23	.12	.03
5	.32	.09	.38	.23	.05	.05	.06	.16	.25	.23	.10	.03
6	.25	.62	.23	.22	.42	1.75	.06	.20	.13	.12	.06	.17
7	.30	.07	.24	.06	.07	.05	21.7	.36	.12	.04	.09	.04
8	.27	.16	.07	.06	.07	.05	5.05	50.3	.11	.04	.07	.04
9	.28	.09	.05	.05	.08	.06	1.04	1.62	.10	.06	.04	.11
10	.29	.09	.05	1.43	.10	.08	.41	1.08	.17	.04	.08	.04
11	.24	.11	.10	57.5	.06	.15	.33	.68	.16	.05	.04	.04
12	.26	.08	230	.78	.07	.12	.38	.32	.59	.05	.07	.04
13	.25	.08	1.17	.05	.06	.10	.32	.24	1.59	.04	.05	.03
14	.27	.18	.93	.04	.05	2.01	.25	66.6	.15	.04	.03	.06
15	.28	.13	.40	.04	.07	.37	.25	19.5	.20	.03	.04	161
16	.25	.06	.53	.04	.12	.10	.31	1.35	.17	.03	.05	3.60
17	.29	.06	57.6	.04	.11	.07	.16	1.20	.10	.02	.06	.19
18	.24	.09	.23	.04	.10	.10	.10	1.19	.08	11.0	.06	.11
19	.23	.11	.05	.05	.12	.13	.18	.97	.08	97.1	.04	.09
20	.23	.24	.05	.05	.07	.10	.17	.70	.14	3.35	.06	.06
21	.31	.11	.05	.05	.10	.18	.76	.23	.10	.55	.04	.07
22	.28	.06	.05	.07	55.2	.11	.74	.32	.07	.33	.08	.08
23	.23	.07	.07	.05	35.1	.08	5.51	.40	.04	.08	.05	.05
24	.32	.07	.04	.05	.70	.08	.92	.40	.04	.05	.04	.07
25	.31	.05	.14	.04	.23	.07	35.2	.40	.04	.06	.06	.05
26	.23	.06	.04	7.09	.23	.08	2.26	.40	.06	.04	.06	.04
27	.29	.07	.14	.46	.34	.08	.77	.34	.13	.04	.04	.05
28	.31	.07	.04	.15	10.1	.08	.52	.23	.11	.05	.07	.07
29	.25	.09	.04	.05	-----	.05	.40	.23	.62	.04	.06	.05
30	.25	26.7	8.03	.06	-----	.08	.35	.23	.80	1.04	.03	.04
31	.39	-----	.75	.09	-----	.07	-----	.23	-----	.31	.03	-----
Total	8.60	60.26	603.03	70.00	103.89	48.76	78.53	150.76	6.99	115.99	1.98	166.38
Mean	.28	2.01	19.5	2.26	3.71	1.57	2.62	4.86	.23	3.74	.064	5.55
Max	.43	30.3	234	57.5	55.2	33.6	35.2	66.6	1.59	97.1	.12	161
Min	.23	.05	.04	.04	.05	.05	.04	.16	.04	.02	.03	.03
Acre-Ft	17	120	1200	139	206	97	156	299	14	230	3.9	330
wtr Year 2015	Total	1415.17	Mean	3.88	Max	234	Min	.02	Inst Max	3030	Acre-Ft	2810
Cal Year 2014	Total	1517.32	Mean	4.16	Max	432	Min	0	Inst Max	2430	Acre-Ft	3010

RUNOFF – DAILY DISCHARGE

Los Angeles County Dept of Public Works

USDAY V106 Output 03/17/2016

Summary Report

Site: F40 Walnut Creek Below Puddingstone Dam
 USGS #:
 Beginning Date: 10/01/2014
 Ending Date: 09/30/2015

Daily Mean Discharge in Cubic feet/second Water Year Oct 2014 to Sep 2015

Day	OCT	NOV	DEC	JAN	FEB	MAR	APR	MAY	JUN	JUL	AUG	SEP
1	0	.02	.01	.06	.07	.01	0	.03	0	.07	.19	.25
2	0	0	.11	.05	.10	.02	0	.06	0	.06	.21	.20
3	0	0	.02	.03	.11	.03	0	.08	0	.03	.13	.20
4	0	0	0	.06	.10	.02	0	.14	0	.03	.15	.22
5	0	0	.01	.07	.02	.03	0	.15	0	.06	.16	.21
6	0	2.08	.02	.04	.02	.02	0	.08	.01	.07	.18	.20
7	0	0	.02	.04	.03	.01	.02	.08	0	.06	.15	.20
8	0	0	.03	0	.03	.01	.06	.11	0	.04	.17	.15
9	0	0	.03	0	.03	.02	.04	.06	0	.04	.18	.04
10	0	0	.02	.01	.02	.05	.02	.04	0	.06	.16	.07
11	0	0	0	.08	0	.05	.01	.02	0	.06	.18	.03
12	0	0	.10	.02	0	.01	.01	.04	0	.09	.16	.04
13	0	0	.08	0	0	.01	.01	.02	0	.06	.13	.09
14	0	0	.01	.02	.01	.03	0	.04	0	.04	.15	.08
15	0	0	.03	.01	.01	0	0	.05	0	.01	.14	.17
16	0	0	.04	0	.02	0	0	.04	0	0	.04	.13
17	0	0	.03	.01	0	0	0	.06	0	.01	.04	.14
18	0	0	.02	.01	.01	0	0	.09	0	.05	.10	.19
19	0	0	.02	0	0	0	0	.05	.02	.06	.11	.14
20	0	0	.02	0	0	.01	0	.03	.01	.03	.10	.15
21	0	0	.01	0	0	0	0	.03	0	0	.13	.13
22	0	0	.02	.02	.01	.01	0	.06	0	0	.14	.19
23	0	0	.04	.04	.04	.02	1.44	.05	.01	.04	.17	.22
24	0	0	.02	0	.03	0	.13	0	.01	.07	.18	.18
25	0	.02	.01	.01	.05	0	.12	.01	.01	.07	.15	.15
26	0	.01	.07	.02	.03	0	.13	0	0	.07	.17	.15
27	0	0	.10	.01	.02	0	.14	.01	0	.05	.19	.11
28	0	0	.07	.01	.01	0	.07	.01	0	.11	.19	.10
29	0	0	.06	.05	-----	0	.02	0	.02	.13	.19	.12
30	0	0	.04	0	-----	0	0	0	.05	.14	.21	.08
31	0	-----	.01	.01	-----	0	-----	0	-----	.17	.19	-----
Total	0	2.13	1.07	0.68	0.77	0.36	2.22	1.44	0.14	1.78	4.74	4.33
Mean	0	.071	.035	.022	.028	.012	.074	.046	.005	.057	.15	.14
Max	0	2.08	.11	.08	.11	.05	1.44	.15	.05	.17	.21	.25
Min	0	0	0	0	0	0	0	0	0	0	.04	.03
Acre-Ft	0	4.2	2.1	1.3	1.5	.71	4.4	2.9	.28	3.5	9.4	8.6
Wtr Year 2015	Total	19.66	Mean	.054	Max	2.08	Min	0	Inst Max	255	Acre-Ft	39
Cal Year 2014	Total	28.69	Mean	.079	Max	5.22	Min	0	Inst Max	473	Acre-Ft	57

APPENDIX D

HYDROLOGIC REPORT 2014 – 2015

RUNOFF - STREAM GAGING STATION PEAK FLOW

RUNOFF – STREAM GAGING STATION PEAK FLOW

**ALHAMBRA WASH above Klingerman Street
STATION NO. F81D-R**

Season	Daily CFS			Total Runoff (Acre-feet)	Peak Flow	
	Maximum	Minimum	Mean		Date	CFS
1929-30	N.D.	0	N.D.	635	Mar 14	1,870
1930-31	226	0	2.1	1,480	Feb 03	1,530
1931-32	220	0	2.7	1,940	Jan 31	1,120
1932-33	418	0	2.3	1,680	Jan 19	1,850
1933-34	1,770	0	8	5,820	Jan 01	4,890
1934-35	219	0	3.3	2,380	Jan 05	2,280
1935-36	144	0	2	1,420	Feb 12	1,700
1936-37	309	0	5.4	3,880	Mar 15	2,470
1937-38	997	0	7.6	5,520	Mar 02	5,010
1938-39	288	0	4.1	2,990	Jan 05	2,480
1939-40	130	0	2.4	1,730	Feb 01	1,280
1940-41	219	0	7.8	5,650	Mar 03	2,080
1941-42	193	0	2.5	1,810	Dec 10	2,320
1942-43	893	0	8.4	6,070	Mar 04	4,480
1943-44	454	+	5.6	4,100	Feb 22	1,860
1944-45	199	0.1	3.1	2,250	Nov 11	2,220
1945-46	342	0.1	4.1	3,000	Dec 22	1,600
1946-47	345	0.1	5.2	3,800	Nov 13	3,810
1947-48	155	0.1	2.8	2,040	Mar 24	2,670
1948-49	95	0.2	2.8	2,020	Dec 17	758
1949-50	254	0.2	4.3	3,090	Feb 06	1,630
1950-51	106	0.2	3.3	2,360	Jan 11	1,620
1951-52	594	0.2	12.5	9,040	Jan 16	3,810
1952-53	228	0.1	4.5	3,240	Nov 15	3,140
1953-54	369	0.2	5.2	3,770	Feb 13	2,410
1954-55	185	0.2	4.2	3,020	Jan 18	1,890
1955-56	1,100	0.3	7.6	5,520	Jan 26	4,550
1956-57	242	0.6	6.1	4,440	Feb 23	3,090
1957-58	544	0.3	12.8	9,270	Feb 19	4,830
1958-59	279	0.2	4.2	3,020	Jan 06	3,170
1959-60	200	0.1	3.8	2,720	Jan 11	1,710
1960-61	153	0.3	2.5	1,790	Nov 05	1,480
1961-62	382	0.1	9.1	6,270	Feb 12	2,560

M Data missing

* Record incomplete

E Estimate

N.D. Not determined

** Record not computed

+ Less than 0.05 acre feet or less than 0.05 cfs, but greater than 0

RUNOFF – STREAM GAGING STATION PEAK FLOW

**ALHAMBRA WASH above Klingerman Street
STATION NO. F81D-R**

Season	Daily CFS			Total Runoff (Acre-feet)	Peak Flow	
	Maximum	Minimum	Mean		Date	CFS
1962-63	359	0.1	4	2,880	Mar 16	2,210
1963-64	196	0.2	4	2,870	Jan 21	2,210
1964-65	339	0.1	6.4	4,610	Apr 09	3,730
1965-66	686	0.3	10.7	7,740	Nov 24	3,520
1966-67	662	0.4	12.2	8,820	Jan 22	3,550
1967-68	398	0.4	6.5	4,740	Mar 08	3,480
1968-69	999	0.4	17	12,300	Feb 06	3,980
1969-70	486	0.3	5.3	1,871	Feb 28	3,430
1970-71	648	0.4	7.1	2,601	Nov 29	4,040
1971-72	449	0.3	2.5	3,000	Dec 24	2,000
1972-73	555	0.3	12.6	9,110	Feb 11	4,450
1973-74	813	0.3	7.9	5,720	Jan 07	4,330
1974-75	429	0.3	5.6	4,070	Dec 04	6,000
1975-76	274	0.3	5.3	3,790	Feb 05	1,820
1976-77	252	0.3	6	4,340	Oct 22	1,770
1977-78	695	0.3	17	11,927	Mar 01	5,950
1978-79	836	0.3	10.5	7,614	Mar 27	4,484
1979-80	1,240	0.3	18.4	13,051	Feb 16	6,660
1980-81	196	0.1	5.1	3,720	Mar 19	2,750
1981-82	371	0.2	6	4,317	Mar 17	2,410
1982-83	1,050	0.1	17.8	12,941	Mar 01	7,010
1983-84	235	0.4	3.7	2,715	Dec 25	2,480
1984-85	260	0.3	4.9	3,543	Dec 19	3,050
1985-86	329	0.3	9.2	6,633	Mar 08	4,130
1986-87	177	0.6	3.6	2,579	Oct 02	5,670
1987-88	386	0.6	7	5,048	Dec 04	4,500
1988-89	226	0.9	5.2	3,570	Dec 21	1,410
1989-90	530	0.9	4.8	3,483	Feb 17	2,010
1990-91	452	0.6	7.6	5,437	Mar 01	2,700
1991-92	570	0.7	13.8	10,008	Feb 12	6,340
1992-93	796	1	20.5	14,810	Dec 07	5,880
1993-94	260	0.5	7.1	5,157	Mar 24	3,000
1994-95	875	0.2	14.3	10,380	Mar 10	8,080

M Data missing

* Record incomplete

E Estimate

N.D. Not determined

** Record not computed

+ Less than 0.05 acre feet or less than 0.05 cfs, but greater than 0

RUNOFF – STREAM GAGING STATION PEAK FLOW

**ALHAMBRA WASH above Klingerman Street
STATION NO. F81D-R**

Season	Daily CFS			Total Runoff (Acre-feet)	Peak Flow	
	Maximum	Minimum	Mean		Date	CFS
1995-96	462	0.4	7	5,071	Jan 31	8,110
1996-97	279	0.3	8.7	6,260	Jan 15	2,640
1997-98	727	0.6	20.2	14,660	Feb 06	7,770
1998-99	142	0.3	6.1	4,400	Nov 28	3,500
1999-00	306	0.4	8.5	6,170	Feb 21	4,480
2000-01	404	0.6	10.2	7,380	Jan 11	3,220
2001-02	326	0.8	7.5	5,457	Nov 24	6,153
2002-03	882	0.5	13.3	9,652	Mar 15	5,980
2003-04	785	0.3	10	7,539	Feb 26	6,030
2004-05	982	0	27.3	19,800	Feb 20	7,180
2005-06	469	0.7	11.9	8,590	Jan 02	6,098
2006-07	194	1.6	8	5,769	Feb 11	2,552
2007-08	596	0.05	10.4	7,540	Jan 04	5,556
2008-09	355	1.1	9.2	6,630	Feb 05	5,360
2009-10	558	0.4	12.8	9,260	Jan 18	5,490
2010-11	758	0.34	14.4	10,440	Dec 22	3,260
2011-12	274	0.35	6.29	4,560	Mar 17	3,280
2012-13	127	0.17	3.75	2,710	Oct 11	1,070
2013-14	346	0.33	3.03	2,200	Feb 28	2,090
2014-15	317	0.26	4.61	3,340	Dec 12	5,950

M Data missing

* Record incomplete

E Estimate

N.D. Not determined

** Record not computed

+ Less than 0.05 acre feet or less than 0.05 cfs, but greater than 0

RUNOFF – STREAM GAGING STATION PEAK FLOW

**ARCADIA WASH below Grand Ave
STATION NO. F317-R**

Season	Daily CFS			Total Runoff (Acre-feet)	Peak Flow	
	Maximum	Minimum	Mean		Date	CFS
1956-57	108	0.1	1.8	1,340	Feb 23	1,184
1957-58	212	0.1	4.6	3,330	Feb 01	1,932
1958-59	127	0.2	1.9	1,360	Jan 06	1,270
1959-60	101	0.3	1.7	1,220	Apr 27	593
1960-61	69	+	1.1	831	Nov 05	570
1961-62	408	0.1	4.7	3,400	Feb 11	1,480
1962-63	153	0.2	2.1	1,510	Feb 09	600
1963-64	120	0.1	2.2	1,620	Nov 20	1,340
1964-65	153	0.1	3.1	2,270	Apr 09	1,460
1965-66	267	0.1	4.7	3,430	Dec 29	1,270
1966-67	283	0.3	6.3	4,560	Jan 22	1,260
1967-68	M	M	M	M		M
1968-69	M	M	M	M		M
1969-70	M	M	M	M		M
1970-71	M	M	M	M		M
1971-72	M	M	M	M		M
1972-73	M	M	M	M		M
1973-74	279	0.3	4	2,910	Jan 07	931
1974-75	207	0.3	3.2	2,290	Dec 04	2,560
1975-76	167	0.3	3.6	2,600	Sep 11	1,400
1976-77	119	0.2	2.9	2,121	Oct 23	1,320
1977-78	355	0.2	9.4	6,823	Feb 10	4,110
1978-79	128	0.2	4.5	3,263	Mar 27	1,290
1979-80	633	0	9.9	7,025	Jan 29	3,280
1980-81	104	0.4	2.8	1,991	Jan 29	1,050
1981-82	208	0.4	4.3	3,137	Mar 17	2,470
1982-83	435	0.4	10.8	7,824	Mar 01	4,110
1983-84	121	0	3.2	2,354	Oct 01	1,430
1984-85	137	0.1	4.7	3,399	Dec 19	1,420
1985-86	211	0	8.4	6,116	Mar 08	1,760
1986-87	172	0.1	3.5	2,530	Oct 02	2,410
1987-88	284	0.1	5.4	3,915	Jan 17	4,360
1988-89	114	0.1	3.7	2,521	Dec 21	507

M Data missing

* Record incomplete

E Estimate

N.D. Not determined

** Record not computed

+ Less than 0.05 acre feet or less than 0.05 cfs, but greater than 0

RUNOFF – STREAM GAGING STATION PEAK FLOW

**ARCADIA WASH below Grand Ave
STATION NO. F317-R**

Season	Daily CFS			Total Runoff (Acre-feet)	Peak Flow	
	Maximum	Minimum	Mean		Date	CFS
1989-90	728	0.1	3.5	2,505	Apr 17	1,330
1990-91	228	0.1	5	3,598	Feb 28	2,120
1991-92	301	0.1	11.1	8,043	Feb 12	3,190
1992-93	586	0.3	17.3	12,560	Jan 17	2,720
1993-94	239	0	6.4	4,661	Mar 19	1,360
1994-95	480	0.1	11.1	8,032	Mar 11	2,740
1995-96	405	0.4	5.2	3,764	Feb 20	1,560
1996-97	206	0.5	6.3	4,540	Jan 26	1,430
1997-98	489	0.6	13.3	9,640	Feb 06	2,850
1998-99	151	0.5	4.2	3,020	Jan 26	1,040
1999-00	162	0.1	4.3	3,150	Feb 21	1,750
2000-01	240	0.2	6	4,320	Jan 11	1,380
2001-02	161	0.6	2.6	1,904	Nov 24	2,712
2002-03	0	0	6.5	0	Mar 15	2,120
2003-04	320	0.5	4.5	3,272	Feb 26	2,660
2004-05	558	0.3	16.6	12,000	Oct 20	3,680
2005-06	230	0.1	5.8	4,170	Jan 02	3,005
2006-07	116	0	2	1,446	Feb 11	950
2007-08	381	0.1	7.5	5,449	Jan 04	3,823
2008-09	186	0.2	4.4	3,200	Feb 05	2,210
2009-10	275	0.1	6.5	4,720	Jan 18	2,530
2010-11	384	0.4	8.86	6,420	Dec 22	3,030
2011-12	126	0.35	3.47	2,520	Apr 13	2,500
2012-13	78	0.23	3.11	2,250	May 09	1,070
2013-14	239	0.32	2.26	1,630	Feb 28	1,190
2014-15	161	0.06	3.26	2,360	Dec 12	3,270

M Data missing

* Record incomplete

E Estimate

N.D. Not determined

** Record not computed

+ Less than 0.05 acre feet or less than 0.05 cfs, but greater than 0

RUNOFF – STREAM GAGING STATION PEAK FLOW

ARROYO SECO below Devil's Gate Dam STATION NO. F277-R

Season	Daily CFS			Total Runoff (Acre-feet)	Peak Flow	
	Maximum	Minimum	Mean		Date	CFS
1942-43	3,190	0	33.4	23,896	Jan 23	5,640
1943-44	965	0	12.4	8,316	Feb 20	1,540
1944-45	187	0.1	3.7	2,560	Mar 15	610
1945-46	272	0	2.2	1,599	Dec 23	445
1946-47	410	0	5.7	4,148	Dec 27	610
1947-48	2	0	0.1	52		2
1948-49	1	0	0	18	Jun 13	2
1949-50	21	0	0.1	70	Nov 10	106
1950-51	0	0	0	1	Sep 04	26
1951-52	788	0	15.5	11,462	Jan 18	999
1952-53	12	0	0.1	77	Jan 11	25
1953-54	70	0	0.9	622	Jan 25	127
1954-55	2	0	0.3	195	Apr 30	14
1955-56	327	0	2	1,473	Jan 27	411
1956-57	6	0	0.3	234	Oct 04	124
1957-58	351	0	10.9	7,648	Feb 04	546
1958-59	129	0	0.7	482	Feb 16	156
1959-60	2	0	0.4	261	Jan 11	7
1960-61	70	0	0.6	435	Nov 25	360
1961-62	544	0	7.4	5,004	Feb 11	891
1962-63	12	0	0.5	372	Jun 21	51
1963-64	41	0	0.4	308	Jun 26	214
1964-65	28	0	0.4	313	Jul 12	128
1965-66	1,683	0	18.5	13,337	Nov 23	2,110
1966-67	858	0	9.4	6,903	Dec 06	1,620
1967-68	N.D.					
1968-69	N.D.					
1969-70	N.D.					
1970-71	N.D.					
1971-72	N.D.					
1972-73	N.D.					
1973-74	N.D.					
1974-75	48	0	0.9	689	Apr 01	1,225

M Data missing

* Record incomplete

E Estimate

N.D. Not determined

** Record not computed

+ Less than 0.05 acre feet or less than 0.05 cfs, but greater than 0

RUNOFF – STREAM GAGING STATION PEAK FLOW

ARROYO SECO below Devil's Gate Dam STATION NO. F277-R

Season	Daily CFS			Total Runoff (Acre-feet)	Peak Flow	
	Maximum	Minimum	Mean		Date	CFS
1975-76	281	0	1.8	1,289	Sep 11	1,040
1976-77	175	0	2.9	2,094	May 09	450
1977-78	1,670	0	43.9	31,799	Mar 04	5,790
1978-79	177	0	6.5	4,692	Feb 21	321
1979-80	3,156	0	41.1	28,630	Feb 17	4,844
1980-81	84	0	3.1	2,266	Mar 24	314
1981-82	934	0	9.1	6,620	Mar 18	1,276
1982-83	2,700	0.1	37.4	27,063	Mar 02	3,260
1983-84	100	0	1.5	1,075	Dec 01	526
1984-85	250	0	2.4	1,754	Dec 21	873
1985-86	109	0	4	2,877	Mar 15	349
1986-87	N.D.					
1987-88	124	0	0	0		
1988-89	52	0	1.5	1,042	Feb 09	52
1989-90	12	0	72.4	285		
1990-91	572	0	7	506		
1991-92	3,530	0	44.6	32,380	Feb 11	5,970
1992-93	403M	1.3M	8.8M	3210.05M		M
1993-94	84	0.1	2.5	1,842	Mar 23	1,330
1994-95	505	0	33.9	24,566	Feb 13	691
1995-96	408	0	4.7	3,443	Feb 21	477
1996-97	77	0	2.3	1,679	Jan 15	362
1997-98	164	0	14	10116.63E		N.D.
1998-99	16E	0	0.6	455.25E		N.D.
1999-00	325E	0	4.3	3090E		N.D.
2000-01	620E	0	16.2	11760E		N.D.
2004-05	8,110	0.4	185	125,000	Jan 09	11,700
2005-06	826	2	15.4	11,140	Feb 28	2,172
2006-07	209	0.1	6.6	4,768	Feb 27	1,384
2007-08	658	0	18.4	13,359	Jan 04	6,479
2008-09	292	0.07	3.69	2,670	Oct 26	1,970
2009-10	1,140	0.1	23.9	17,320	Jan 18	8,910
2010-11	1,860	0.46	57.5	41,660	Dec 21	8,910

M Data missing

* Record incomplete

E Estimate

N.D. Not determined

** Record not computed

+ Less than 0.05 acre feet or less than 0.05 cfs, but greater than 0

RUNOFF – STREAM GAGING STATION PEAK FLOW

**ARROYO SECO below Devil's Gate Dam
STATION NO. F277-R**

Season	Daily CFS			Total Runoff (Acre-feet)	Peak Flow	
	Maximum	Minimum	Mean		Date	CFS
2011-12	35	0.38	2.68	1,950	Apr 18	479
2012-13	31	0	0.59	428	Oct 11	546
2013-14	133	0	0.61	440	Feb 28	298
2014-15	27	0	0.38	276	Sep 15	200

M Data missing

* Record incomplete

E Estimate

N.D. Not determined

** Record not computed

+ Less than 0.05 acre feet or less than 0.05 cfs, but greater than 0

RUNOFF – STREAM GAGING STATION PEAK FLOW

BALLONA CREEK above Sawtelle Blvd STATION NO. F38C-R

Season	Daily CFS			Total Runoff (Acre-feet)	Peak Flow	
	Maximum	Minimum	Mean		Date	CFS
1927-28	N.D.	0	N.D.	3,930	May 08	1,100
1928-29	1,150	0	20.6	14,900	Mar 10	4,990
1929-30	1,130	0	18.6	13,480	Jan 11	4,460
1930-31	1,500	0	25.6	18,520	Apr 26	6,280
1931-32	1,780	0	30	21,790	Dec 28	6,130
1932-33	1,660	0	21.8	15,810	Jan 19	7,000
1933-34	4,310	0	28.5	20,630	Jan 01	11,300
1934-35	2,190	0	34.4	24,870	Apr 08	11,200
1935-36	929	0	19.3	13,500	Feb 12	8,070
1936-37	2,160	0	56.2	40,680	Dec 30	8,940
1937-38	7,330	3.6	72.5	52,500	Mar 02	19,000
1938-39	3,080	1.8	39.4	28,490	Dec 17	9,900
1939-40	1,270	1.3	29.1	21,110	Feb 03	9,730
1940-41	2,680	3.1	93	67,360	Dec 23	17,300
1941-42	990	2.8	23.8	17,250	Dec 10	7,500
1942-43	4,840	2.6	47.3	34,240	Jan 22	13,200
1943-44	3,010	3.4	45.4	33,000	Feb 22	8,800
1944-45	1,200	3	33.8	24,450	Nov 11	9,380
1945-46	1,830	3.8	25.4	18,380	Dec 22	7,750
1946-47	1,960	2.8	36.3	26,300	Dec 25	9,630
1947-48	1,000	3.5	18.8	13,630	Mar 24	12,700
1948-49	668	2.8	22.2	16,090	Feb 07	5,740
1949-50	1,620	1.4	32.1	23,250	Feb 06	7,670
1950-51	756	0.7	26.1	18,860	Jan 10	5,460
1951-52	2,520	3.5	73.5	53,350	Jan 16	12,800
1952-53	1,140	4.8	27.5	19,910	Nov 15	11,500
1953-54	3,570	5.4	39.3	28,480	Feb 13	18,900
1954-55	1,210	5.4	29.8	21,600	Jan 18	9,370
1955-56	6,510	5.2	44.7	34,590	Jan 26	18,700
1956-57	1,790	6.3	30.7	22,240	Feb 23	13,900
1957-58	3,000	6.3	59.4	43,040	Feb 19	15,200
1958-59	1,210	4.2	19	13,730	Jan 06	8,170

M Data missing

* Record incomplete

E Estimate

N.D. Not determined

** Record not computed

+ Less than 0.05 acre feet or less than 0.05 cfs, but greater than 0

RUNOFF – STREAM GAGING STATION PEAK FLOW

BALLONA CREEK above Sawtelle Blvd STATION NO. F38C-R

Season	Daily CFS			Total Runoff (Acre-feet)	Peak Flow	
	Maximum	Minimum	Mean		Date	CFS
1959-60	1,290	2.2	23.7	17,190	Jan 11	12,500
1960-61	945	4.2	17.3	12,560	Nov 05	7,700
1961-62	3,490	3.2	69.2	50,090	Feb 19	12,900
1962-63	1,940	3.2	29.6	21,450	Mar 16	12,100
1963-64	789	3.9	24.8	18,000	Jan 22	6,420
1964-65	1,590	3.9	38	27,540	Apr 09	17,600
1965-66	3,620	5.3	61.5	44,540	Nov 22	18,000
1966-67	3,020	6.7	62.1	45,300	Nov 07	13,900
1967-68	6,350	8.2	55.9	40,570	Nov 21	32,500
1968-69	4,840	8.2	101	73,060	Jan 25	17,000
1969-70	1,380	7.6	30.7	22,230	Feb 28	1,380
1970-71	3,170	8.8	50.8	35,620	Nov 29	14,600
1971-72	1,900	7.6	31.3	22,700	Dec 24	11,100
1972-73	2,590	8.8	65.9	47,730	Jan 16	17,600
1973-74	3,510	8.8	56.8	41,060	Jan 07	11,000
1974-75	2,490	6.2	47.8	34,590	Dec 04	20,560
1975-76	1,390	6.2	30.6	22,230	Sep 10	12,940
1976-77	1,760	4.6	38.6	27,930	Oct 23	10,173
1977-78	4,441	4.2	112.8	81,659	Feb 10	28,088
1978-79	2,220	6.6	60.3	43,680	Mar 27	9,710
1979-80	4,630	6.2	99.2	70,454	Feb 15	27,000
1980-81	1,090	6.6	27.8	20,111	Mar 02	7,300
1981-82	1,380	5.8	41.3	29,922	Apr 01	8,110
1982-83	5,690	8.2	119	86,347	Mar 01	23,100
1983-84	1,440	10	36.7	26,672		N.D.
1984-85	1,810	8.2	38.3	27,714	Feb 09	9,670
1985-86	2,750	8.8	67.7	49,043	Feb 14	17,200
1986-87	752	7.6	19.4	13,986		N.D.
1987-88	2,920	5	57.5	41,772	Dec 04	13,400
1988-89	941	7.6	1.3	27,763	Dec 17	3,580
1989-90	3,140	7.6	32.3	23,364	Feb 17	8,090
1990-91	2,150	3	37.5	27,133	Mar 19	10,800

M Data missing

* Record incomplete

E Estimate

N.D. Not determined

** Record not computed

+ Less than 0.05 acre feet or less than 0.05 cfs, but greater than 0

RUNOFF – STREAM GAGING STATION PEAK FLOW

BALLONA CREEK above Sawtelle Blvd STATION NO. F38C-R

Season	Daily CFS			Total Runoff (Acre-feet)	Peak Flow	
	Maximum	Minimum	Mean		Date	CFS
1991-92	2,490	7	62.3	45,191	Feb 12	17,200
1992-93	*	*	*	*		*
1993-94	1,450	9.7	38.9	28,150	Feb 07	14,400
1994-95	4,680	9.4	103	74,450	Mar 10	24,000
1995-96	2,930	12	53.4	38,740	Jan 31	8,230
1996-97	1,830	9.7	54.8	39,670	Dec 09	9,890
1997-98	3,040	8.3	111	80,630	Feb 06	22,900
1998-99	1,260	10	41.7	30,160	Jan 31	6,150
1999-00	1,690	7.8	61.2	44,450	Feb 21	12,500
2000-01	2,540	7.9	86.4	62,520	Jan 11	19,400
2001-02	1,128	9.8	36.9	26,698	Nov 24	12,167
2002-03	4,058	7.6	76.1	55,088	Mar 15	17,100
2003-04	2,042	8.2	49	35,411	Feb 25	15,000
2004-05	5,230	16	182	132,000	Dec 29	16,500
2005-06	2,300	22	89.8	65,010	Jan 02	11,250
2006-07	919	18.7	47.5	34,377	Sep 22	7,053
2007-08	2,570	4.3	110.2	80,006	Jan 25	11,898
2008-09	2,130	1.1	40.8	29,570	Nov 26	10,300
2009-10	2,520	3.5	55.2	39,980	Jan 18	14,700
2010-11	3,670	4.01	75.9	54,970	Dec 22	13,400
2011-12	1,400	2.28	34	24,680	Nov 20	11,100
2012-13	917	4.66	26	18,810	Mar 08	6,030
2013-14	2,560	4.48	29.8	21,560	Feb 28	7,900
2014-15	2,080	1.6	33.6	24,340	Sep 15	11,700

M Data missing

* Record incomplete

E Estimate

N.D. Not determined

** Record not computed

+ Less than 0.05 acre feet or less than 0.05 cfs, but greater than 0

RUNOFF – STREAM GAGING STATION PEAK FLOW

BIG DALTON CREEK below Big Dalton Dam STATION NO. F120B-R

Season	Daily CFS			Total Runoff (Acre-feet)	Peak Flow	
	Maximum	Minimum	Mean		Date	CFS
1939-40	1	0	0.3	207		
1940-41	66	0	4	2,889	Mar 05	67
1941-42	3	0	0.3	235		
1942-43	103	0	4.4	3,182	Mar 04	111
1943-44	35	0	1.7	1,160	Feb 23	56
1944-45	13	0	1.2	840	Mar 15	34
1945-46	5	0	0.8	549	Dec 23	34
1946-47	11	0	0.8	546	Oct 03	30
1947-48	3	0	0	15	Feb 05	20
1948-49	7	0	0.1	100	Dec 18	25
1949-50	9	0	0.2	122	Jan 21	11
1950-51	2	0	0	15	Jan 11	10
1951-52	33	0	2.2	1,607	Jan 19	34
1952-53	7	0	0.1	107	Jan 15	38
1953-54	9	0	0.5	363	Feb 15	9
1954-55	4	0	0	7	Oct 01	7
1955-56	25	0	0.3	222	Aug 08	37
1956-57	12	0	0	23	Nov 09	18
1957-58	28	0	3	2,145	Apr 05	37
1958-59	15	0	0.2	139	Apr 13	31
1959-60	2	0	0	10	Jul 21	5
1960-61	14	0	0.2	166	Nov 14	37
1961-62	25	0	1.4	1,002	Feb 17	25
1962-63	18	0	0.2	162	Oct 08	35
1963-64	18	0	0.4	296	Jan 22	2
1964-65	20	0	0.3	220	Apr 26	20
1965-66	32	0	2.8	1,997	Nov 22	52
1966-67	216	0	6.7	4,840	Dec 06	615
1967-68	N.D.					
1968-69	N.D.					
1969-70	N.D.					
1970-71	N.D.					
1971-72	N.D.					

M Data missing

* Record incomplete

E Estimate

N.D. Not determined

** Record not computed

+ Less than 0.05 acre feet or less than 0.05 cfs, but greater than 0

RUNOFF – STREAM GAGING STATION PEAK FLOW

BIG DALTON CREEK below Big Dalton Dam STATION NO. F120B-R

Season	Daily CFS			Total Runoff (Acre-feet)	Peak Flow	
	Maximum	Minimum	Mean		Date	CFS
1972-73	N.D.					
1973-74	N.D.					
1974-75	11	0	0.4	296	May 06	125
1975-76	13	0	0.7	488	Jun 08	19
1976-77	1	0	0	21	Apr 12	2
1977-78	226	0	0.3	6,186	Mar 05	263
1978-79	17	0	0.1	1,735	Apr 12	1,735
1979-80	564	0.1	0.3	7,436	Feb 17	1,170
1980-81	5	0	0.5	361	Jan 29	22
1981-82	22	0	1.2	903	Mar 25	22
1982-83	268	0.1	7.6	5,466	Mar 01	457
1983-84	7	0	0	705	Dec 25	8
1984-85	8	0	0.8	585	Dec 19	11
1985-86	16	0	1.2	855	Mar 19	18
1986-87	5	0	0.2	214	Jan 27	7
1987-88	8	0	0.6	444	Sep 12	9
1988-89	10	0	0.5	364	Feb 15	17
1989-90	5	0	0.1	69	Jan 26	5
1990-91	11	0	0.6	455	Mar 28	11
1991-92	20	0	1.6	1,161	Feb 19	22
1992-93	311	0	9.9	7,136	Jan 16	415
1993-94	10	0	0.4	296	Apr 06	13
1994-95	99	0	5.7	3,814	Feb 23	146
1995-96	28	0	1.7	1,251	Feb 22	71
1996-97	18	0	1.5	1,100	Jan 27	19
1997-98	183	0	6.5	4,700	Feb 23	539
1998-99	459	0	2.7	1,970	Oct 14	1,300
1999-00	10	0	0.3	241	Mar 27	11
2000-01	10	0	0.4	320	Sep 27	20
2001-02	1	0	0	27	Dec 14	2
2002-03	15	0	0.8	565	May 03	79
2003-04	16	0	0.9	626	Mar 02	25
2004-05	467	0.1	10.2	7,350		

M Data missing

* Record incomplete

E Estimate

N.D. Not determined

** Record not computed

+ Less than 0.05 acre feet or less than 0.05 cfs, but greater than 0

RUNOFF – STREAM GAGING STATION PEAK FLOW

**BIG DALTON CREEK below Big Dalton Dam
STATION NO. F120B-R**

Season	Daily CFS			Total Runoff (Acre-feet)	Peak Flow	
	Maximum	Minimum	Mean		Date	CFS
2005-06	13	0.1	1.9	1,380	Dec 07	146
2006-07	13	1.1	0.1	823	Oct 19	314
2007-08	21	0	0.7	495	Jun 11	127
2008-09	6	0	0.8	601	Feb 06	16
2009-10	3	0	0.6	418	Nov 10	32
2010-11	63	0	2.83	2,050	Apr 14	450
2011-12	10	0	0.85	614	Oct 19	421
2012-13	10	0	0.26	191	Apr 23	52
2013-14	3.97	0	0.089	64	Jul 31	9.35
2014-15	1.94	0	0.069	50	Apr 30	3.63

M Data missing

* Record incomplete

E Estimate

N.D. Not determined

** Record not computed

+ Less than 0.05 acre feet or less than 0.05 cfs, but greater than 0

RUNOFF – STREAM GAGING STATION PEAK FLOW

BIG ROCK CREEK upstream from Pallett Creek STATION NO. F394-R

Season	Daily CFS			Total Runoff (Acre-feet)	Peak Flow	
	Maximum	Minimum	Mean		Date	CFS
1986-87	39	0.1	4.2	3,065	Mar 06	45
1987-88	83	0	8.8	6,422		
1988-89	13	2	4.7	3,547		
1989-90	4	0.3	2	1,323		
1990-91	27	0	4.1	4,003		
1991-92	95	1.2	24.6	17,880	Feb 11	93
1992-93*	151	8.5	55.9	28,729		
1993-94*	28	3.3	10.3	6,828		
1994-95*	4,500	2.6	57.3	36,513		
1995-96	1,510	2.1	15.6	11,297	Feb 21	6,020
1996-97*	204	0.7	7.2	5,187	Dec 09	2,750
1997-98	2,900	0.5	48.6	35,210	Feb 23	13,900
1998-99	18	1	4.4	3,190	Nov 28	57
1999-00*	330	0.5	3.9	2,854	Feb 20	3,450
2000-01	36	0.9	9	6,540	Jan 11	68
2001-02	1	0.1	0.3		Sep 04	1
2002-03	0	0	8.3	0	Feb 12	1,230
2003-04	105	104	4.9	3,580	Feb 26	410
2004-05	1,600	2	93.7	67,670	Jan 09	2,800
2005-06	195	5.8	21.9	10,950	Feb 28	549
2006-07	11	0.7	5.2	3,730	Oct 18	17
2007-08	386	0.5	9.3	6,761	Jan 27	742
2008-09	73	0.07	7.8	5,630	Feb 19	120
2009-10	99	0.96	14.6	10,560	Jan 18	287
2010-11	711	1.51	40.6	29,410	Dec 20	1,770
2011-12	20	0.81	7.4	5,370	Sep 09	106
2012-13	8	0.16	1.4	1,010	Dec 02	10
2013-14	235	0	1.88	1,360	Feb 28	1,080
2014-15	70	0	2.01	1,450	Dec 12	306

M Data missing

* Record incomplete

E Estimate

N.D. Not determined

** Record not computed

+ Less than 0.05 acre feet or less than 0.05 cfs, but greater than 0

RUNOFF – STREAM GAGING STATION PEAK FLOW

BIG TUJUNGA CREEK below Big Tujunga Dam
STATION NO. F168B-R

Season	Daily CFS			Total Runoff (Acre-feet)	Peak Flow	
	Maximum	Minimum	Mean		Date	CFS
2012-13	35	0.09	4.07	2,950	May 07	66
2013-14	18.1	1.16	3.25	2,350	Feb 28	54
2014-15	7.77	1.02	1.93	1,400	Jul 19	96.7

M Data missing

* Record incomplete

E Estimate

N.D. Not determined

** Record not computed

+ Less than 0.05 acre feet or less than 0.05 cfs, but greater than 0

RUNOFF – STREAM GAGING STATION PEAK FLOW

**BOUQUET CREEK above Bouquet Canyon Road
STATION NO. F377B-R**

Season	Daily CFS			Total Runoff (Acre-feet)	Peak Flow	
	Maximum	Minimum	Mean		Date	CFS
2003-04	44	0	0.5	356	Feb 25	329
2004-05	1,050	0	12.1	8,760	Jan 10	3,330
2005-06	95	0	1.3	846	Jan 02	800
2006-07	9	0	3.1	68	Sep 22	141
2007-08	168	0	1.6	1,125	Feb 10	753
2008-09	30	0	0.7	498	Apr 17	51
2009-10	36	0	0.53	386	Apr 11	247
2010-11	299	0	1.5	1,080	Apr 12	1,510
2011-12	50	0	0.37	271	Apr 13	816
2012-13	8	0	0.043	31	Jan 24	83
2013-14	76.2	0	0.34	248	Feb 28	719
2014-15	54.7	0	0.54	393	Dec 12	1,510

M Data missing

* Record incomplete

E Estimate

N.D. Not determined

** Record not computed

+ Less than 0.05 acre feet or less than 0.05 cfs, but greater than 0

RUNOFF – STREAM GAGING STATION PEAK FLOW

**BRADBURY CHANNEL below Central Avenue
STATION NO. F329-R**

Season	Daily CFS			Total Runoff (Acre-feet)	Peak Flow	
	Maximum	Minimum	Mean		Date	CFS
1957-58	7.3	0	0.2	170	Feb 19	65
1958-59	29	0	0.3	182	Jan 06	1250
1959-60	5.2	0	0.1	59	Dec 24	40
1960-61	4.5	0	0	30	Nov 03	60
1961-62	50	0	0.7	518	Jan 20	316
1962-63	9.4	0	0.2	120	Feb 09	24
1963-64	5.6	0	0.2	114	Jan 22	168
1964-65	11	0	0.2	157	Apr 09	248
1965-66	46	0	0.6	448	Dec 29	552
1966-67	52	0	0.7	547	Jan 24	280
1967-68	30	0	0.4	319	Mar 08	370
1968-69	131	0	2.6	938	Feb 06	472
1969-70	47	0	0.6	408	Mar 01	267
1970-71	20	0	0.4	261	Dec 21	130
1971-72	24	0	0.2	172	Dec 24	145
1972-73	61	0	1.2	438	Feb 27	424
1973-74	39	0	0.8	609	Jan 07	111
1974-75	28	0	0.4	268	Dec 04	325
1975-76	14	+	0.4	326	Sep 11	210
1976-77	26.4	+	0.5	374	Oct 23	166
1977-78	75.6	+	2.7	1670	Feb 10	357
1978-79	49	0	1.6	1160	Jan 15	297
1979-80	155	0	8.3	5984	Jan 28	574
1980-81	29.7	0	1.1	781	Jan 29	477
1981-82	41.2	0	1.2	870	Mar 17	305
1982-83	111	0	2.4	1716	Sep 29	422
1983-84	21.7	0	0.7	549	Oct 01	230
1984-85	24.4	0	0.9	672		N.D.
1985-86	34.8	0	0.8	581	Jan 31	267
1986-87	5.7	0	0.5	361	Jan 04	174
1987-88	166	0	2.8	2019	Dec 04	286
1988-89	25.3	0	1.1	758	Feb 04	119
1989-90	19.6	0.1	1.2	877	May 28	20

M Data missing

* Record incomplete

E Estimate

N.D. Not determined

** Record not computed

+ Less than 0.05 acre feet or less than 0.05 cfs, but greater than 0

RUNOFF – STREAM GAGING STATION PEAK FLOW

**BRADBURY CHANNEL below Central Avenue
STATION NO. F329-R**

Season	Daily CFS			Total Runoff (Acre-feet)	Peak Flow	
	Maximum	Minimum	Mean		Date	CFS
1990-91	44.6	0	1.8	1267	Feb 27	391
1991-92	50.9	0	1.2	877	Feb 12	334
1992-93	83.6	0	3.2	2310	Jan 14	534
1993-94	14.6	0	0.6	470	Mar 24	193
1994-95	82.7	0	2.3	1652	Feb 14	170
1995-96	97.6	0	1.8	1283	Feb 20	320
1996-97	28	+	1	708	Nov 21	168
1997-98	71	+	1.5	1110	Feb 07	400
1998-99	16	+	0.5	351	Jan 26	170
1999-00	25	+	1.1	826	Feb 20	297
2000-01	36	+	1.4	1000	Jan 11	195
2001-02	18.4	0	0.3	221.4	Nov 24	325
2002-03	41.4	0	0.8	546.4	Feb 13	249
2003-04	1.8	0	0.4	8.7	Feb 26	241
2004-05	135	0	4.2	3050	Feb 21	470
2005-06	25	0	1.8	1320	Apr 14	320
2006-07	10.9	0	0.5	354.3	Sep 22	177
2007-08	43.4	0	0.8	593	Jan 04	376
2008-09	20.3	0	0.55	396	Feb 05	250
2009-10	27.8	0	0.95	691	Jan 18	262
2010-11	48.6	0	0.99	715	Dec 22	256
2011-12	10.2	0	0.38	279	Feb 27	232
2012-13	4.93	0	0.18	133	Oct 11	158
2013-14	22	0	0.19	135	Feb 28	204
2014-15	16.9	0	0.26	185	Jul 19	346

M Data missing

* Record incomplete

E Estimate

N.D. Not determined

** Record not computed

+ Less than 0.05 acre feet or less than 0.05 cfs, but greater than 0

RUNOFF – STREAM GAGING STATION PEAK FLOW

BRANFORD STREET CHANNEL below Sharp Avenue STATION NO. F342-R

Season	Daily CFS			Total Runoff (Acre-feet)	Peak Flow	
	Maximum	Minimum	Mean		Date	CFS
1961-62	118	0	1.0*	743*	Feb 19	206
1962-63	46	0	0.6	415	Apr 26	284
1963-64	32	0	0.5	375	Mar 22	275
1964-65	56	0	0.8	571	Apr 09	261
1965-66	110	0	1.4	982	Dec 29	587
1966-67	79	0	1.2	870	Nov 07	445
1967-68	120	0	1	693	Nov 21	576
1968-69	160	0	3	2,190	Feb 25	738
1969-70	65	0	1	724	Feb 09	462
1970-71	175*	0	1.6*	1,162*	Nov 29	990*
1971-72	50	0	0.5	360	Dec 24	233
1972-73	50	0	2.1	1,530	Feb 11	771
1973-74	90	0	1	710	Jan 07	412
1974-75	75	+	0.9	668	Mar 06	882
1975-76	61	0	0.8	550	Sep 10	742
1976-77	67	0	0.9	633	May 09	490
1977-78	126	0	3	2,153	Feb 10	1,160
1978-79	80	0	1.5	1,052	Mar 27	823
1979-80	158	0	1.9	1,380	Feb 19	1,530
1980-81	46	0	0.6	471	Jan 29	683
1981-82	68	0	1.2	685	Mar 17	688
1982-83	230	0	2.9	2,134	Mar 01	1,520
1983-84	34	0	0.4	326	Dec 25	190
1984-85	53	0	0.6	423	Dec 18	800
1985-86	43	0	1.1	760	Jan 31	728
1986-87	21	0	0.2	144	Nov 17	386
1987-88	123	0	1.5	1,058	Oct 22	1,830
1988-89	30	0	0.7	478	Dec 20	242
1989-90	47	0	0.5	372	Jan 13	383
1990-91	65	0	1	726		N.D.
1991-92	238	0	2.8	2,001	Feb 10	1,450
1992-93	*	*	*	*		*
1993-94	35.3*	0.0*	0.7*	464*		N.D.

M Data missing

* Record incomplete

E Estimate

N.D. Not determined

** Record not computed

+ Less than 0.05 acre feet or less than 0.05 cfs, but greater than 0

RUNOFF – STREAM GAGING STATION PEAK FLOW

**BRANFORD STREET CHANNEL below Sharp Avenue
STATION NO. F342-R**

Season	Daily CFS			Total Runoff (Acre-feet)	Peak Flow	
	Maximum	Minimum	Mean		Date	CFS
1994-95	175*	0.0*	3.0*	2,076*	Mar 10	1,770
1995-96	68	0	0.9	652	Feb 21	574
1996-97	56	0.1	1.3	917	Dec 22	578
1997-98	124	0.1	3.4	2,470	Feb 07	1,240
1998-99	19	0.1	1	717	Oct 29	679
1999-00	63	0.1	1.6	1,130	Apr 18	670
2000-01	95	0.2	2	1,470	Jan 11	1,080
2001-02	39	0.2	0.7	520		
2002-03	197	0.2	2.3	1,668	Mar 15	1,270
2003-04	62	0.1	0.9	635	Feb 26	586
2004-05	161	0.1	4.6	3,300	Jan 09	1,550
2005-06	56	0.1	1.4	1,040	Apr 04	398
2006-07	26	0	0.8	565	Dec 09	462
2007-08	65	0.3	1.5	1,095	Jan 27	486
2008-09	68	0.07	1.4	998	Feb 06	574
2009-10	67	0.01	1.6	1,150	Feb 06	683
2010-11	211	0	2.27	1,640	Mar 20	850
2011-12	44	0.05	0.98	713	Apr 13	881
2012-13	24	0	0.82	594	Mar 08	239
2013-14	146	0.02	1.08	785	Feb 28	1,010
2014-15	75	0	0.93	677	Dec 12	554

M Data missing

* Record incomplete

E Estimate

N.D. Not determined

** Record not computed

+ Less than 0.05 acre feet or less than 0.05 cfs, but greater than 0

RUNOFF – STREAM GAGING STATION PEAK FLOW

BURBANK WESTERN STORM DRAIN at Riverside Dr. STATION NO. E285-R

Season	Daily CFS			Total Runoff (Acre-feet)	Peak Flow	
	Maximum	Minimum	Mean		Date	CFS
1950-51	50	1.2	4	2,870	Jan 11	920
1951-52	310	1.2	8.9	6,490	Jan 16	1,400
1952-53	89	0	4.7	3,400	Dec 20	1,380
1953-54	144	2.1	5.7	4,140	Mar 16	1,070
1954-55	123	1.2	5.6	4,020	Jan 18	849
1955-56	400	2	5.6	4,070	Jan 26	N.D.
1956-57	192	1.6	4.9	3,530	Feb 23	1,770
1957-58	232	1.9	8.2	5,950	Feb 19	1,270
1958-59	222	1.6	4.9	3,540	Feb 11	1,650
1959-60	112	1.7	4.5	3,280	Jan 10	854
1960-61	170	1.7	4.9	3,570	Nov 05	1,400
1961-62	583	1.7	10.2	7,380	Feb 12	2,310
1962-63	444	0.6	6.4	4,640	Feb 09	1,800
1963-64	141	1.7	5.4	3,940	Mar 22	1,220
1964-65	220	1.7	6.9	5,010	Apr 01	2,570
1965-66	897	1.1	11.4	8,290	Dec 29	2,980
1966-67	730	3.4	15.4	11,170	Nov 07	3,500
1967-68	499	4.5	12.7	9,250	Mar 08	2,640
1968-69	982	5	24.4	17,640	Jan 25	2,830
1969-70	198	3.4	9.8	7,080	Mar 04	1,500
1970-71	771	2.2	12.7	9,200	Nov 29	4,600
1971-72	291	3.9	10.3	7,490	Oct 24	1,650
1972-73	478	4.5	16.1	11,670	Jan 18	3,130
1973-74	800	4.5	14.8	10,740	Jan 07	1,860
1974-75	318	5	12.6	9,120	Dec 04	2,370
1975-76	221	4.5	13	9,410	Sep 05	3,030
1976-77	369	7.9	16.8	12,164	Oct 23	2,880
1977-78	1,260	3.9	47.9	34,682	Feb 10	12,300
1978-79	338	3.9	17.1	12,387	Mar 17	2,620
1979-80	1,490	5	31.5	22,500	Feb 16	7,560
1980-81	257	4.5	16.5	11,965	Jan 29	4,340
1981-82	425	2.2	17.3	12,518	Jan 19	3,010
1982-83	1,710	4.5	36.6	26,506	Mar 01	6,320

M Data missing

* Record incomplete

E Estimate

N.D. Not determined

** Record not computed

+ Less than 0.05 acre feet or less than 0.05 cfs, but greater than 0

RUNOFF – STREAM GAGING STATION PEAK FLOW

BURBANK WESTERN STORM DRAIN at Riverside Dr. STATION NO. E285-R

Season	Daily CFS			Total Runoff (Acre-feet)	Peak Flow	
	Maximum	Minimum	Mean		Date	CFS
1983-84	231	2.8	9.8	7,083	Nov 01	2,190
1984-85	363	1.1	9.6	6,981	Dec 19	2,640
1985-86	372	2.8	14	10,104	Jan 31	3,070
1986-87	145	1.7	8.3	5,843	Nov 18	1,150
1987-88	363	7.9	19.4	14,058	Oct 22	6,620
1988-89	194	4.4	12.5	9,071	Dec 16	1,410
1989-90	253	4.1	10	7,258	Feb 04	1,410
1990-91	376	1.2	10.7	8,085		N.D.
1991-92	778	3	35.6	25,812	Feb 10	7,220
1992-93	564	6	33.9	24,570	Feb 07	8,080
1993-94	355	5.7	16.8	12,160	Nov 30	5,600
1994-95	743	2.4	39.6	28,687	Mar 10	6,880
1995-96	1,330	5.3	22	15,950	Feb 21	5,270
1996-97	293	6.5	14.2	10,310	Jan 20	2,400
1997-98	844	8.4	29.9	21,670	Nov 26	N.D.
1998-99	175	7.3	15.1	10,920	Nov 28	2,940
1999-00	279	6.2	16.3	11,840	Nov 23	3,920
2000-01	417	6.6	20.9	15,120	Jan 11	4,620
2001-02	175	4.6	12.8	9,255	Nov 24	3,771
2002-03	846	6.9	18.5	13,388	Mar 15	4,470
2003-04	396	1.6	1.3	9,338	Feb 26	2,640
2004-05	765	7.6	45.3	32,800	Feb 20	5,390
2005-06	478	7.2	21.9	15,830	Jan 02	3,381
2006-07	174	8.9	18.9	13,669	Sep 22	2,241
2007-08	516	5.6	25.9	18,770	Jan 04	3,264
2008-09	331	4	13.7	9,900	Feb 05	3,850
2009-10	530	1.7	20.6	14,920	Feb 06	7,050
2010-11	1,180	7.49	38.6	27,980	Dec 22	5,060
2011-12	333	4.09	15.1	10,960	Mar 25	4,490
2012-13	203	6.73	16	11,580	Mar 08	1,810
2013-14	454	4.01	12.4	9,010	Feb 28	3,690
2014-15	233	1.16	12.2	8,760	Dec 12	3,610

M Data missing

* Record incomplete

E Estimate

N.D. Not determined

** Record not computed

+ Less than 0.05 acre feet or less than 0.05 cfs, but greater than 0

RUNOFF – STREAM GAGING STATION PEAK FLOW

**COMPTON CREEK near Greenleaf Drive.
STATION NO. F37B-R**

Season	Daily CFS			Total Runoff (Acre-feet)	Peak Flow	
	Maximum	Minimum	Mean		Date	CFS
1927-28	*	0	*	1230*	Mar 05	240*
1928-29	197	0	3.1	2,270	Mar 10	924
1929-30	144	0	3.5	2,520	Mar 14	580
1930-31	137	+	3.3	2,400	Apr 26	678
1931-32	248	0	4.4	3,220	Jan 31	757
1932-33	166	0	2.4	1,780	Jan 19	740
1933-34	372	0	3.5	2,560	Jan 01	960
1934-35	301	0	5.7	4,170	Apr 08	850
1935-36	143	0	4	2,920	Feb 12	824
1936-37	559	0	*	*	Feb 06	1,220
1937-38	986E	*	*	*	Mar 02	N.D.
1938-39	837	0	7.1	5,150	Sep 25	2,150
1939-40	256	10	7.4	5,340	Feb 03	1,630
1940-41	544	1	22.7	16,400	Dec 23	2,660
1941-42	236	3	10.1	7,280	Dec 10	1,730
1942-43	752	0.8	11.8	8,560	Jan 22	2,050
1943-44	739	2.3	15.6	11,290	Feb 20	2,370
1944-45	363	4.4	12.7	9,210	Nov 11	3,010
1945-46	362	2.6	11	7,960	Dec 23	2,010
1946-47	474	4.1	13.9	10,080	Nov 12	2,930
1947-48	170	0.6	7.9	5,740	Mar 24	1,410
1948-49	282	0.1	5.1	3,660	Dec 17	2,710
1949-50	433	+	6.6	4,820	Feb 06	2,830
1950-51	209	+	4.9	3,550	Jan 10	1,790
1951-52	661	0.1	14.7	10,650	Jan 18	3,220E
1952-53	220	0.1	5.6	4,020	Nov 15	2,380
1953-54	797	0.1	7.5	5,410	Feb 13	3,600
1954-55	374	0.1	8.4	6,080	Jan 18	2,710
1955-56	2,090	0.2	12.7	9,240	Jan 26	4,910
1956-57	286	+	5.6	4,070	May 11	1,780
1957-58	1,100	+	16	11,610	Feb 19	4,640
1958-59	449	0	4.6	3,330	Jan 06	4,320

M Data missing

* Record incomplete

E Estimate

N.D. Not determined

** Record not computed

+ Less than 0.05 acre feet or less than 0.05 cfs, but greater than 0

RUNOFF – STREAM GAGING STATION PEAK FLOW

**COMPTON CREEK near Greenleaf Drive.
STATION NO. F37B-R**

Season	Daily CFS			Total Runoff (Acre-feet)	Peak Flow	
	Maximum	Minimum	Mean		Date	CFS
1959-60	463	0	6.3	4,590	Jan 11	3,220
1960-61	204	+	2.7	1,960	Nov 05	1,640
1961-62	1,060	0.1	14.5	10,520	Feb 19	4,550
1962-63	576	+	8.8	6,400	Feb 10	3,310
1963-64	212	+	4.7	3,440	Nov 06	2,430
1964-65	424	0	7.4	5,390	Apr 09	2,630
1965-66	809	+	10.8	7,800	Dec 29	3,250
1966-67	765	+	11.8	8,560	Nov 07	4,650
1967-68	1,120	+	9.4	6,850	Mar 07	3,690
1968-69	1,040	0	16.6	12,010	Jan 20	5,890
1969-70	275	0.2	4.4	3,150	Jan 16	1,960
1970-71	609	0.4	11.7	8,500	Nov 29	2,930
1971-72	622	0.4	6.8	4,940	Dec 27	6,000
1972-73	473	0.2	12.2	8,830	Nov 14	4,300
1973-74	810	0.3	10	7,210	Jan 04	3,140
1974-75	677	0.2	9.1	6,550	Dec 04	8,690
1975-76	285	0.1	4.6	3,270	Feb 09	2,470
1976-77	542	0	7.2	5,220	Aug 17	1,970
1977-78	688	0	20	14,471	Mar 01	3,620
1978-79	559	+	12.3	8,888	Mar 27	2,410
1979-80	*	*	*	*	Feb 16	4,780
1980-81	440	0.1	6.4	4,658	Mar 01	2,970
1981-82	237	0.3	6.3E	4,647E	Jan 01	2,720
1982-83	1,010	0.4	21.9	16,720	Jan 28	6,020
1983-84	277	0.3	5.4	3,893	Nov 24	2,380
1984-85	458	0.1	7.4	5,354	Dec 19	4,110
1985-86	*	*	*	*		*
1986-87	187	0.4	4	2,935	Nov 17	1,670
1987-88	443	0.3	8	5,826	Dec 04	2,980
1988-89	258	0.6	5.9	4,254	Dec 21	1,990
1989-90	755	0.2	5.4	3,887	Feb 17	2,500
1990-91	527	0.5	9.1	6,586	Mar 19	3,940

M Data missing

* Record incomplete

E Estimate

N.D. Not determined

** Record not computed

+ Less than 0.05 acre feet or less than 0.05 cfs, but greater than 0

RUNOFF – STREAM GAGING STATION PEAK FLOW

**COMPTON CREEK near Greenleaf Drive.
STATION NO. F37B-R**

Season	Daily CFS			Total Runoff (Acre-feet)	Peak Flow	
	Maximum	Minimum	Mean		Date	CFS
1991-92	510	0.1	15.5	11,228	Mar 20	4,640
1992-93	717	0.1	21.8	15,760	Jan 06	5,240
1993-94	290	0.2	6	4,315	Nov 30	2,680
1994-95	1,120	0	15.8	11,440	Jan 04	7,660
1995-96	627	0.5	8	5,792	Jan 31	3,410
1996-97	402	0.7	10.1	7,300	Dec 09	2,510
1997-98	826	0.7	26.9	19,500	Feb 06	7,040
1998-99	384	0.2	9	6,540	Nov 08	2,420
1999-00	611	0	7.6	5,480	Mar 05	6,150
2000-01	525	0	10.6	7,710	Jan 11	3,250
2001-02	403	0	7.1	15,512	Nov 24	2,519
2002-03	997	0	12.3	8,881	Mar 15	4,750
2003-04	876	0	9.4	6,796	Nov 12	8,030
2004-05	1,320	0	26.1	18,900	Dec 28	5,530
2005-06	344	0.3	7.4	5,380	Jan 02	3,407
2006-07	80	0	1.5	1,118	Apr 20	857
2007-08	272	0	6.7	4,843	Jan 23	1,888
2008-09	417	0	5.4	3,900	Feb 16	3,360
2009-10	403	0	6.8	4,930	Jan 20	3,670
2010-11	741	0	9.77	7,070	Dec 22	2,870
2011-12	135	0	2.59	1,880	Mar 25	2,100
2012-13	73	0	1.57	1,140	Dec 26	345
2013-14	166	0	1.81	1,310	Feb 28	530
2014-15	299	0	3.44	2,490	Sep 15	3,300

M Data missing

* Record incomplete

E Estimate

N.D. Not determined

** Record not computed

+ Less than 0.05 acre feet or less than 0.05 cfs, but greater than 0

RUNOFF – STREAM GAGING STATION PEAK FLOW

**COYOTE CREEK below Spring Street.
STATION NO. F354-R**

Season	Daily CFS			Total Runoff (Acre-feet)	Peak Flow	
	Maximum	Minimum	Mean		Date	CFS
1963-64	1,190	+	10.9	7,950	Nov 15	N.D.
1964-65	800	0.3	16.9	12,220	Apr 09	3,350
1965-66	1,830	1.2	32.5	23,500	Dec 29	5,020
1966-67	1,840	1.4	37.9	27,450	Jan 22	6,880
1967-68	2,350	1.6	26.8	19,570	Mar 08	6,970
1968-69	4,420	3.1	88.8	64,290	Jan 20	11,300
1969-70	1,000	2.5	23	16,680	Feb 10	4,600
1970-71	2,320	1.4	32.9	23,820	Dec 19	6,200
1971-72	1,770	*	*	*	Dec 27	6,620
1972-73	2,350	3.3	60.4	43,720	Nov 14	7,810
1973-74	2,410	2.3	38.3	27,700	Jan 07	8,670
1974-75	3,130	2.3	36.9	26,700	Dec 04	14,400
1975-76	1,500	2.3	24.5	17,540	Feb 06	5,430
1976-77	4,250	1.7	37.5	27,000	May 08	13,400
1977-78	4,400	1.5	128.4	92,940	Mar 01	13,700
1978-79	*	*	*	*		*
1979-80	4,380	4	128.4	91,800	Feb 14	19,400
1980-81	2,030	4.9	33.7	24,395	Mar 01	7,980
1981-82	4,020	4.6	56.2	40,818	Nov 28	12,200
1982-83	5,100	3.4	123	89,013	Mar 01	19,700
1983-84	2,670	5.2	1.5	32,043	Oct 01	9,620
1984-85	*	*	*	*		*
1985-86	*	*	*	*	Feb 14	*
1986-87	2,980	4.9	34.1	24,670	Jan 04	11,100
1987-88	2,940	3.1	46.8	33,943	Dec 04	7,630
1988-89	1,360	3	45	32,582		N.D.
1989-90	648	2.3	18.5	13,410	Jan 16	2,980
1990-91	2,250	3.4	49.7	35,630	Mar 01	6,250
1991-92	3,120	0	61.3	44,518	Feb 12	21,000
1992-93	5,030	3.8	147	106,400	Dec 07	13,600
1993-94	M	M	M	M		M
1994-95	*	*	*	*	Mar 11	11,500
1995-96	2,990	2.8	41.9	30,380	Feb 20	15,500

M Data missing

* Record incomplete

E Estimate

N.D. Not determined

** Record not computed

+ Less than 0.05 acre feet or less than 0.05 cfs, but greater than 0

RUNOFF – STREAM GAGING STATION PEAK FLOW

**COYOTE CREEK below Spring Street.
STATION NO. F354-R**

Season	Daily CFS			Total Runoff (Acre-feet)	Peak Flow	
	Maximum	Minimum	Mean		Date	CFS
1996-97	2,120	3.5	72	52,160	Dec 09	10,100
1997-98	3,370	1.5	135	97,460	Feb 07	13,800
1998-99	748	3	35.7	25,830	Nov 08	4,570
1999-00	1,180	3.9	33.7	24,430	Feb 23	5,100
2000-01	3,030E	3.6E	71.2E	51,510E	Jan 11	15,300
2001-02	921	2	33	17,758	Dec 21	2,371
2002-03	3,907	2.9	116	84,197	Dec 16	16,200
2003-04	3,337	6.3	70	50,590	Feb 26	11,600
2004-05	8,730	8.7	415	30,000	Jan 09	20,800
2005-06	2,240	0	90.3	65,350	Mar 28	9,862
2006-07	1,040	1.2	27.4	19,802	Sep 22	3,707
2007-08	1,560	1.9	66.2	48,031	Jan 05	6,642
2008-09	2,510	1.2	43.4	31,440	Dec 15	14,000
2009-10	1,020	0.1	20	14,520	Apr 12	6,610
2010-11	3,870	7.55	112	80,800	Dec 22	15,600
2011-12	1,090	5.89	55	39,930	Apr 13	7,310
2012-13	1,200	5.02	49	35,450	Dec 24	4,990
2013-14	2,230	1.3	49.5	35,830	Feb 28	6,350
2014-15	1,710	0.16	35.5	25,700	Sep 15	7,940

M Data missing

* Record incomplete

E Estimate

N.D. Not determined

** Record not computed

+ Less than 0.05 acre feet or less than 0.05 cfs, but greater than 0

RUNOFF – STREAM GAGING STATION PEAK FLOW

DALTON WASH at Merced Avenue STATION NO. F274B-R

Season	Daily CFS			Total Runoff (Acre-feet)	Peak Flow	
	Maximum	Minimum	Mean		Date	CFS
1940-41	206	0	5.3	3,844	Mar 13	674
1941-42	42	0	1	727	Dec 10	230
1942-43	336	0	4.8	3,500	Jan 22	1,230
1943-44	1,620	0	2.2	1,620	Feb 22	2,650
1944-45	144	0	1.2	894	Nov 11	1,740
1945-46	229	0	2.2	1,610	Dec 23	1,450
1946-47	52	0	1.4	984	Nov 23	328
1947-48	20	0	0.1	96	Dec 05	149
1948-49	19	0	0.1	97	Dec 17	181
1949-50	38	0	0.4	306	Dec 18	232
1950-51	11	0	0.1	64	Jan 11	175
1951-52	270	0	2.9	2,090	Jan 16	1,070
1952-53	39	0	0.4	287	Nov 15	549
1953-54	217	0	1.5	1,060	Feb 13	1,290
1954-55	88	0	1	706	Jan 18	668
1955-56	860	0	3.1	2,260	Jan 26	2,350
1956-57	165	0	1.4	980	Mar 01	1,990
1957-58	303	0	6.5	4,690	Mar 16	1,310
1958-59	208	0	3	2,130	Jan 06	2,700
1959-60	2,260	0.1	3.1	2,260	Jan 10	1,000
1960-61	150	0.2	3.1	2,220	Jan 26	1,468
1961-62	511	0.1	9.9	7,200	Nov 20	4,270
1962-63	403	0.2	5.7	4,110	Mar 16	2,020
1963-64	169	0.1	3.8	2,750	Jan 21	1,530
1964-65	290	0.1	4.4	3,170	Apr 09	2,800
1965-66	571	0.2	8.8	6,310	Nov 22	1,320
1966-67	693	0.3	14	10,140	Sep 01	3,970
1967-68	414	0.3	5.9	4,310	Mar 08	3,254
1968-69	3,120	0.3	47	34,300	Jan 25	6,550
1969-70	447	1.2	68	49,270	Feb 01	4,775
1970-71	404	0.8	88	63,700	Dec 21	2,320
1971-72	599	0.8	54	39,430	Dec 24	3,570
1972-73	629	0.8	121	87,820	Feb 02	4,240

M Data missing

* Record incomplete

E Estimate

N.D. Not determined

** Record not computed

+ Less than 0.05 acre feet or less than 0.05 cfs, but greater than 0

RUNOFF – STREAM GAGING STATION PEAK FLOW

DALTON WASH at Merced Avenue STATION NO. F274B-R

Season	Daily CFS			Total Runoff (Acre-feet)	Peak Flow	
	Maximum	Minimum	Mean		Date	CFS
1973-74	839	0.8	112	81,260	Jan 04	2,140
1974-75	550	0.8	66.8	48,320	Dec 04	5,060
1975-76	282	0.8	74.1	53,640	Sep 10	2,190
1976-77	210	1	14.2	10,280	Jan 03	3,240
1977-78	*	*	*	*	Mar 05	*
1978-79	582	0.1	101.6	73,533	Mar 27	5,610
1979-80	2,790	+	83.4	59,890	Feb 16	10,000
1980-81	379	1	21.9	15,861	Mar 01	1,830
1981-82	568	0.6	53.4	38,651	Mar 14	3,750
1982-83	1,690	0	52.2	37,757	Feb 27	6,130
1983-84	347	0	40.2	28,405	Dec 25	3,360
1984-85	322	0.1	57.6	41,683	Nov 08	3,500
1985-86	496	0.1	39.1	28,298	Mar 08	5,550
1986-87	347	0	65.7	46,865	Oct 02	2,980
1987-88	421	0.1	47.9	34,807	Dec 04	4,984
1988-89	286	1.3	60	43,310	Dec 21	3,408
1989-90	151	8	56	39,890	Apr 17	5,390
1990-91	593	0	18.1	13,700	Mar 01	3,288
1991-92	529	0.1	10	7,252	Feb 12	5,270
1992-93	790	0	37.8	27,370	Jan 14	6,120
1993-94	169	0.1	6.2	4,470	Apr 26	3,390
1994-95	1,070	0.1	19.6	14,160	Jan 10	4,790
1995-96	925	0.2	13.7	9,920	Feb 18	6,760
1996-97	370	0.1	30.2	21,890	Dec 09	3,130
1997-98	1,070	0.1	22.4	16,220	Feb 07	6,630
1998-99	127	0.1	7.2	5,240	Nov 28	2,820
1999-00	291	0.1	28.3	20,520	Feb 12	3,040
2000-01	408	0.1	22.1	16,030	Jan 11	2,280
2001-02	282	0	29.6	21,371	Dec 20	2,556
2002-03	941	0.2	33.7	24,370	Dec 16	4,040
2003-04	552	0.1	29	21,158	Apr 01	3,410
2004-05	3,430	0.1	76.9	55,700	Oct 20	10,700
2005-06	402	0.1	17.2	12,460	Jan 02	5,535

M Data missing

* Record incomplete

E Estimate

N.D. Not determined

** Record not computed

+ Less than 0.05 acre feet or less than 0.05 cfs, but greater than 0

RUNOFF – STREAM GAGING STATION PEAK FLOW

**DALTON WASH at Merced Avenue
STATION NO. F274B-R**

Season	Daily CFS			Total Runoff (Acre-feet)	Peak Flow	
	Maximum	Minimum	Mean		Date	CFS
2006-07	248	0	21.6	15,660	Feb 11	2,524
2007-08	683	0.1	9.8	7,124	Jan 05	7,406
2008-09	489	0.3	12.5	9,080	Feb 05	5,020
2009-10	544	0.4	21.4	15,470	Jan 18	5,170
2010-11	1,280	0.26	37.8	27,340	Dec 22	7,770
2011-12	353	0.03	9.21	6,680	Apr 13	5,120
2012-13	105	0.14	4.01	2,910	Nov 30	817
2013-14	384	0.07	3.18	2,300	Feb 28	3,300
2014-15	276	0.02	40	28,880	Dec 12	5,120

M Data missing

* Record incomplete

E Estimate

N.D. Not determined

** Record not computed

+ Less than 0.05 acre feet or less than 0.05 cfs, but greater than 0

RUNOFF – STREAM GAGING STATION PEAK FLOW

**EATON WASH at Loftus Drive.
STATION NO. F318-R**

Season	Daily CFS			Total Runoff (Acre-feet)	Peak Flow	
	Maximum	Minimum	Mean		Date	CFS
1956-57	201	0	0	2,400	Feb 23	1,760
1957-58	368	0.1	0.1	7,460	Feb 19	2,700
1958-59	245	0.1	0.1	2,850	Jan 06	3,480
1959-60	186	+	+	2,420	Jan 12	1,090
1960-61	123	0.1	0.1	1,590	Nov 26	1,200
1961-62	598	0.1	0.1	6,880	Feb 11	1,950
1962-63	311	0.3	0.3	2,980	Feb 09	1,230
1963-64	227	0.1	0.1	3,050	Nov 20	2,360
1964-65	254	0.2	0.2	3,760	Apr 09	2,150
1965-66	605	0.3	0.3	8,990	Dec 29	2,290
1966-67	548	0.3	0.3	8,670	Jan 24	2,100
1967-68	318	0.3	0.3	4,040	Mar 08	2,390
1968-69	1,860	0.3	0.3	M		M
1969-70	M	M	M	M		M
1970-71	M	M	M	M		M
1971-72	M	M	M	M		M
1972-73	M	M	M	M		M
1973-74	592	0.3	0.3	4,870	Jan 07	1,530
1974-75	480	0.5	0.5	4,870	Dec 04	3,000
1975-76	275	0.4	0.4	3,980	Sep 11	2,660
1976-77	206	0.4	0.4	3,650	Oct 23	1,820
1977-78	914	0.4	0.4	21,425	Feb 10	5,810
1978-79	335	0.3	0.3	7,156	Feb 21	2,630
1979-80	1,460	0.1	0.1	27,991	Feb 16	5,240
1980-81	203	0.3	0.3	3,937	Mar 19	1,630
1981-82	377	0.4	0.4	5,453	Mar 17	3,060
1982-83	1,570	0.5	0.5	28,952		N.D.
1983-84	191	0.4	0.4	3,307	Dec 25	1,930
1984-85	199	0.4	0.4	4,258	Dec 19	2,460
1985-86	313	0.4	0.4	4,827	Jan 31	1,730
1986-87	178	0.1	0.1	1,782	Oct 02	1,400
1987-88	317	0	0	3,048	Jan 17	4,950
1988-89	172	0.1	0.1	2,134	Dec 15	1,150

M Data missing

* Record incomplete

E Estimate

N.D. Not determined

** Record not computed

+ Less than 0.05 acre feet or less than 0.05 cfs, but greater than 0

RUNOFF – STREAM GAGING STATION PEAK FLOW

**EATON WASH at Loftus Drive.
STATION NO. F318-R**

Season	Daily CFS			Total Runoff (Acre-feet)	Peak Flow	
	Maximum	Minimum	Mean		Date	CFS
1989-90	383	0.1	0.1	2,289	Apr 17	1,310
1990-91	331	0	0	3,948	Feb 28	1,850
1991-92	757	0	0	10,304	Feb 12	3,900
1992-93	664	0	0	21,580	Dec 07	5,090
1993-94	159	0	0	2,122	Mar 24	2,580
1994-95	954	0	0	14,500	Mar 11	5,330
1995-96	551	0.1	0.1	5,734	Jan 31	5,090
1996-97	236	0.1	0.1	4,630	Jan 12	1,010
1997-98	1,070	0.1	0.1	14,050	Feb 23	4,650
1998-99	136	0.2	0.2	1,990	Nov 28	1,430
1999-00	247	0.1	0.1	3,720	Feb 21	2,490
2000-01	352	0.2	0.2	4,680	Jan 11	1,760
2001-02	236	0.2	2.3	1,685	Nov 24	4,059
2002-03	558	0.1	7.4	5,353	Mar 15	3,030
2003-04	411	0.4	4.9	3,580	Feb 26	3,840
2004-05	1,420	0	38.2	27,600	Jan 10	5,450
2005-06	258	0.1	6.4	4,600	Jan 02	2,977
2006-07	96	0.2	1.7	1,248	Feb 11	1,023
2007-08	373	0.1	6.9	5,009	Jan 04	2,977
2008-09	230	0	4.3	3,110	Feb 05	2,420
2009-10	337	0.1	8.8	6,350	Jan 18	2,980
2010-11	557	0.07	12.4	8,950	Dec 22	2,980
2011-12	233	0.11	3.48	2,530	Apr 13	2,170
2012-13	105	0.38	2.64	1,910	Oct 11	1,210
2013-14	318	0.45	2.33	1,690	Feb 28	1,630
2014-15	220	0.12	3.24	2,350	Dec 12	2,910

M Data missing

* Record incomplete

E Estimate

N.D. Not determined

** Record not computed

+ Less than 0.05 acre feet or less than 0.05 cfs, but greater than 0

RUNOFF – STREAM GAGING STATION PEAK FLOW

EATON WASH below Eaton Wash Dam
STATION NO. F271-R

Season	Daily CFS			Total Runoff (Acre-feet)	Peak Flow	
	Maximum	Minimum	Mean		Date	CFS
1940-41	211	0	9.4	6,091	Feb 20	256
1941-42	N.D.					
1942-43	663	0	11.2	6,399	Jan 23	1,080
1943-44	161	0	5.5	1,967	Mar 14	268
1944-45	17	0	0.1	101	Feb 02	26
1945-46	43	0	0.4	265	Dec 22	121
1946-47	63	0	0.7	507	Dec 26	86
1947-48	2	0	0	6	Dec 04	9
1948-49	0	0	0	1	Dec 17	0
1949-50	14	0	0.1	70		
1950-51	2	0	0	8		
1951-52	166	0	2.5	1,827		
1952-53	N.D.					
1953-54	40	0	0.3	199		
1954-55	N.D.					
1955-56	41	0	0.2	150		
1956-57	2	0	0	13		
1957-58	136	0	2.9	2,035	Feb 04	146
1958-59	29	0	0.2	158	Feb 16	164
1959-60	N.D.					
1960-61	N.D.					
1961-62	204	0	1.9	1,299		
1962-63	9	0	0	17		
1963-64	8	0	0	36		
1964-65	35	0	0.5	329		
1965-66	173	0	5.1	3,651		
1966-67	169	0	2.6	1,908		
1967-68	N.D.					
1968-69	N.D.					
1969-70	N.D.					
1970-71	N.D.					
1971-72	N.D.					
1972-73	N.D.					

M Data missing

* Record incomplete

E Estimate

N.D. Not determined

** Record not computed

+ Less than 0.05 acre feet or less than 0.05 cfs, but greater than 0

RUNOFF – STREAM GAGING STATION PEAK FLOW

EATON WASH below Eaton Wash Dam
STATION NO. F271-R

Season	Daily CFS			Total Runoff (Acre-feet)	Peak Flow	
	Maximum	Minimum	Mean		Date	CFS
1973-74	N.D.					
1974-75	27	0	0.6	405	Mar 15	28
1975-76	27	0	0.6	425	Mar 16	80
1976-77	22	0	0.4	315		22
1977-78	206	0	5.3	3,456	Mar 04	867
1978-79	34	0	3.4	2,446	Nov 21	226
1979-80M	N.D.					
1980-81	13	0	0.9	671		
1981-82	29	0	2.1	1,524	Apr 05	112
1982-83	804	0	26.1	18,918	Mar 02	1,210
1983-84	45	0	2.7	1,927	Oct 20	43
1984-85	27	0	1	698	Jan 05	18
1985-86	42	0	2.6	1,933		
1986-87	NO RECORD					
1987-88	21	0	0.9	651	Apr 25	29
1988-89	27	0	0.3	345		
1989-90	10	0	1.3	85		
1990-91	60	0	2.1	1,568	Mar 22	57
1991-92	274	0	8.4	6,132	Feb 11	642
1992-93	441	0	20	14,503	Jan 07	822
1993-94*	16	0	1.1	692		N.D.
1994-95	176	0	10.3	7,469	Jan 10	429
1995-96*	201	0	2.9	2,095	Feb 21	298
1996-97	30	0	1.7	1,263	Jan 27	83
1997-98	252	0	8.8	6,364		N.D.
1998-99	9	0	0.2	142	Jun 02	43
1999-00*	67	0	1	711	Feb 24	180
2000-01	32	0	1.1	795	Apr 16	206
2001-02	8	0	0.2	117	Dec 12	32
2002-03	17	0	0.7	518	Mar 03	97
2003-04	17	0	0.4	300	Aug 02	38
2004-05	156	0	15.4	11,200	Oct 21	310
2005-06	30	0	2	1,480	Oct 17	153

M Data missing

* Record incomplete

E Estimate

N.D. Not determined

** Record not computed

+ Less than 0.05 acre feet or less than 0.05 cfs, but greater than 0

RUNOFF – STREAM GAGING STATION PEAK FLOW

**EATON WASH below Eaton Wash Dam
STATION NO. F271-R**

Season	Daily CFS			Total Runoff (Acre-feet)	Peak Flow	
	Maximum	Minimum	Mean		Date	CFS
2006-07	5	0.1	1.3	16	Mar 15	45
2007-08	61	0	2.7	1,936	Dec 04	657
2008-09	30	0	0.5	368	Feb 11	179
2009-10	132	0	3.1	2,280	Jan 26	305
2010-11	145	0	6.31	4,570	Apr 20	356
2011-12	10	0	0.077	56	Apr 18	646
2012-13	2	0	0.057	41	Oct 11	41
2013-14	20.8	0	0.12	84	Mar 11	97.3
2014-15	17.1	0	0.19	136	Dec 02	86.6

M Data missing

* Record incomplete

E Estimate

N.D. Not determined

** Record not computed

+ Less than 0.05 acre feet or less than 0.05 cfs, but greater than 0

RUNOFF – STREAM GAGING STATION PEAK FLOW

FISH CREEK above mouth of canyon.
STATION NO. U7-R

Season	Daily CFS			Total Runoff (Acre-feet)	Peak Flow	
	Maximum	Minimum	Mean		Date	CFS
1917-18	193	0.1	4.1	2,960	Mar 10	330
1918-19	10	0	0.9	648	Feb 11	21
1919-20	83	+	3	2,160	Mar 02	255
1920-21	120	0	2.3	1,670	Mar 13	286
1921-22	290	0.1	12.4	8,980	Feb 09	505
1922-23	64	0.1	2.1	1,510	Dec 12	186
1923-24	14	0	0.5	344	Mar 26	58
1924-25	132	0	1.7	1,230	Apr 04	N.D.
1925-26	410	0.1	7.2	5,170	Apr 07	N.D.
1926-27	482	0.4	7	5,070	Feb 16	945
1927-28	30	N.D.	1.2	860	Feb 04	97
1928-29	41	0	1.4	1,040	Mar 10	71
1929-30	42	0	1.5	1,070	Jan 15	72
1930-31	26	N.D.	1.2	888	Apr 26	70
1931-32	213	N.D.	4.9	3,560	Dec 28	415
1932-33	167	N.D.	1.8	1,340	Jan 19	299
1933-34	360	N.D.	3.4	2,440	Jan 01	640
1934-35	150	N.D.	4.2	3,080	Apr 08	420
1935-36	80	0.3	4.5	3,280	Feb 02	676
1936-37	142	0.4	9.3	6,770	Dec 30	252
1937-38	752	1	13.2	9,520	Mar 02	2,100
1938-39	50	0.2	2.4	1,750	Dec 19	172
1939-40	43	0.1	2.2	1,570	Jan 08	225
1940-41	255	0.1	12.9	9,340	Mar 04	443
1941-42	23	0.1	1.4	1,030	Dec 10	44
1942-43	874	0.1	14.8	10,720	Jan 23	2,100
1943-44	325	0.5	5.8	4,200	Feb 22	680
1944-45	106	0.2	3.6	2,580	Nov 11	400
1945-46	156	0.1	3.2	2,310	Dec 23	540
1946-47	140	0.1	4	2,910	Dec 26	400
1947-48	9	N.D.	0.7	536	Apr 28	28
1948-49	18	N.D.	0.8	610	Jan 20	35
1949-50	37	0	1.2	888	Dec 18	157

M Data missing

* Record incomplete

E Estimate

N.D. Not determined

** Record not computed

+ Less than 0.05 acre feet or less than 0.05 cfs, but greater than 0

RUNOFF – STREAM GAGING STATION PEAK FLOW

FISH CREEK above mouth of canyon.
STATION NO. U7-R

Season	Daily CFS			Total Runoff (Acre-feet)	Peak Flow	
	Maximum	Minimum	Mean		Date	CFS
1950-51	6	0	0.3	237	Apr 28	16
1951-52	348	0	8.3	6,060	Jan 16	1,360
1952-53	18	0	1.1	813	Dec 01	252
1953-54	110	0	2.1	1,510	Jan 25	376
1954-55	15	0	0.8	567	Jan 18	39
1955-56	155	0	1.5	1,100	Jan 26	544
1956-57	33	0	0.9	674	Jan 13	108
1957-58	212	0	7.8	5,680	Apr 03	608
1958-59	200	0.1	2.2	1,590	Dec 06	2,000E
1959-60	16	0	1.1	794	Apr 27	84
1960-61	23	0	0.6	443	Nov 12	230
1961-62	472	0	6.2	4,480	Feb 11	770
1962-63	71	0	1.3	922	Feb 09	346
1963-64	48	0	0.9	1,107	Jan 21	178
1964-65	48	0	1.3	930	Apr 09	163
1965-66	523	0	8.6	6,200	Dec 29	1,670
1966-67	688	0.6	13.5	9,740	Dec 06	2,250
1967-68	44	0.4	2.3	1,640	Nov 19	282
1968-69	5,540	0.7	55.2	39,980	Jan 25	13,000
1969-70	99	0.8	4.2	3,010	Feb 28	898
1970-71	93	0.6	3.3	2,400	Nov 29	259
1971-72	23	0.1	1	742	Dec 24	62
1972-73	480	0.2	7.4	5,390	Feb 11	1,600
1973-74	234	0.4	4.4	3,210	Jan 07	376
1974-75	30	0.2	2.5	1,803	Dec 04	56
1975-76	41	0.1	1.5	1,050	Mar 01	143
1976-77	45	0	1	760		N.D.
1977-78	386	0.1	15.5	11,242	Feb 10	1,340
1978-79	35	0.2	4.4	3,164	Dec 05	78
1979-80	448	0.4	0.5	10,806	Feb 16	1,590
1980-81	44	0.2	1.7	1,264	Jan 29	190
1981-82	13	0.1	2	1,424	Jan 20	26
1982-83	575	0.4	18.7	13,552	Mar 01	1,230

M Data missing

* Record incomplete

E Estimate

N.D. Not determined

** Record not computed

+ Less than 0.05 acre feet or less than 0.05 cfs, but greater than 0

RUNOFF – STREAM GAGING STATION PEAK FLOW

FISH CREEK above mouth of canyon.
STATION NO. U7-R

Season	Daily CFS			Total Runoff (Acre-feet)	Peak Flow	
	Maximum	Minimum	Mean		Date	CFS
1983-84	35	0	2	1,487	Dec 25	108
1984-85	29	0.1	17.6	1,100		N.D.
1985-86	*	*	*	*		*
1986-87	14	0	1.6	1,156		N.D.
1987-88	49	0	1.5	1,082	Jan 17	115
1988-89	81	0	21.1	1,219	Feb 04	226
1989-90	35	0	0.6	466	Feb 16	176
1990-91	87	0	2.5	1,837	Mar 01	429
1991-92	318	0	10.3	7,481	Feb 12	1,030
1992-93	422	0.3	20.2	14,640	Feb 19	2,370
1993-94	13	0	1.2	843	Feb 20	31
1994-95	248	0.2	10.5	7,620	Mar 05	768
1995-96	295	0.1	5.2	3,797	Feb 21	540
1996-97	125	0.2	4.9	3,520	Dec 22	339
1997-98	500	0.1	10.9	7,860	Mar 03	35
1998-99	2	0.2	1.3	935	Mar 30	2
1999-00	17	0.6	1.7	1,220E		N.D.
2000-01	25	0	1.2	881	Apr 16	98
2001-02	13	0	0.6	419	Jan 27	43
2002-03	102	0	1.8	1,319	Mar 16	291
2003-04	92	0	1.5	1,034	Feb 26	548
2004-05	1,240	0	26.5	19,200	Jan 09	1,750
2005-06	55	1.5	4.5	3,230	Jan 02	336
2006-07	10	0.1	1.7	1,249	Feb 27	23
2007-08	121	0.1	4.8	3,477	Jan 05	548
2008-09	25	0.04	2.1	1,530	Feb 07	77
2009-10	57	0.04	5.6	4,050	Dec 12	182
2010-11	50	0.97	3.17	2,300	Dec 18	50
2011-12	19	1.31	3.28	2,380	Apr 13	19
2012-13	15	1.97	3.33	2,410	Jul 01	18.6
2013-14	25.1	1.05	2.19	1,590	Feb 28	25.1
2014-15	19.7	0.5	1.29	932	Dec 12	19.7

M Data missing

* Record incomplete

E Estimate

N.D. Not determined

** Record not computed

+ Less than 0.05 acre feet or less than 0.05 cfs, but greater than 0

RUNOFF – STREAM GAGING STATION PEAK FLOW

**LITTLE ROCK CREEK above Little Rock Dam.
STATION NO. L1-R**

Season	Daily CFS			Total Runoff (Acre-feet)	Peak Flow	
	Maximum	Minimum	Mean		Date	CFS
1930-31	195	0	5	3,610	Apr 26	430
1931-32	830	0	*	16,730*	Feb 08	2,200
1932-33	56	0	5.8	4,180	Mar 09	66
1933-34	455	0	5.2	3,770		N.D.
1934-35	716	0	24.4	17,640	Feb 05	925
1935-36	127	0	4.6	3,320	Feb 23	261
1936-37	679	0	30.3	21,950	Feb 06	1,550
1937-38	N.D.	0	N.D.	N.D.	Mar 02	17,000
1938-39	NO RECORDS					
1939-40	183	0	9.6	7,000	Jan 08	555
1940-41	1,730	0	71.3	51,620	Feb 20	2,240
1941-42	55	+	7.1	5,140	Apr 14	92
1942-43	2,730.0E	0	49.5	35,870	Jan 23	5,700
1943-44	736	0.8	49.6	35,940	Feb 22	902
1944-45	323	0.1	12.8	9,250	Nov 11	1,080
1945-46	604	0	16.7	12,150	Dec 21	1,100
1946-47	1,740	0	21.9	15,840	Dec 26	3,180
1947-48	62	0	3.4	2,450	Apr 29	122
1948-49	33	0	4.4	3,170	Apr 14	37
1949-50	114	0	3.4	2,470	Feb 06	212
1950-51	5	0	0.6	432	May 04	5
1951-52	311	0	31.6	22,890	Dec 30	502
1952-53	33	0	4.2	3,020	Jan 09	36
1953-54	328	0	11.6	8,430	Jan 25	655
1954-55	116	+	10.1	7,310	Nov 11	236
1955-56	424	0	7.5	5,470	Jan 26	1,050
1956-57	399	0	6.3	4,560	Jan 13	1,040
1957-58	521	0	40.7	29,500	Dec 15	1,070
1958-59	163	0	5.7	4,150	Feb 16	598
1959-60	15	0	2.4	1,750	Jan 26	17
1960-61	25	0	1.8	1,290	Nov 06	37
1961-62	2,060	0	25.8	18,640	Feb 11	3,180
1962-63	112	0	3	2,200	Feb 10	314

M Data missing

* Record incomplete

E Estimate

N.D. Not determined

** Record not computed

+ Less than 0.05 acre feet or less than 0.05 cfs, but greater than 0

RUNOFF – STREAM GAGING STATION PEAK FLOW

**LITTLE ROCK CREEK above Little Rock Dam.
STATION NO. L1-R**

Season	Daily CFS			Total Runoff (Acre-feet)	Peak Flow	
	Maximum	Minimum	Mean		Date	CFS
1963-64	38	0	3.8	2,800	Apr 01	49
1964-65	115	0	7.1	5,150	Apr 19	155
1965-66	1,700	0	33.9	24,500	Dec 29	5,240
1966-67	1,330	0	29.2	21,230	Dec 06	1,970
1967-68	264	+	11.6	8,390	Nov 21	444
1968-69	1,810	+	57.2	41,430	Jan 25	5,900
1969-70	175	0	9.5	6,850	Feb 10	287
1970-71	453	0	10.6	7,700	Nov 29	1,490
1971-72	382	0	6	4,320	Dec 24	801
1972-73	556	0	16.1	11,680	Feb 11	1,880
1973-74	70	0	10.4	7,540	Mar 02	87
1974-75	124	0	7.8	5,640	Mar 08	230
1975-76	270	0	7.6	5,530	Feb 08	643
1976-77	74	0	7.3	5,296	May 08	181
1977-78	*	*	*	*	Feb 10	*
1978-79	249	0.5	25.6	18,562	Mar 27	367
1979-80	1,705	0	45.8	32,580	Feb 19	3,998
1980-81	44	0	5.9	4,726	Mar 20	59
1981-82	575	0	18.3	13,243	Apr 11	1,132
1982-83	2,413	0	66.5	48,136	Mar 01	3,482
1983-84	244	0	7.1	5,124	Dec 25	539
1984-85	36	0	8	5,764	Dec 27	45
1985-86	515	0	17.3	12,510	Jan 30	1,162
1986-87	64	0	2.5	1,818	Mar 06	87
1987-88	205	0	25.1	18,286		N.D.
1988-89	47	0	6.3	4,701	Feb 09	61
1989-90	*	*	*	*	Jan 23	41
1990-91	369	0	8.6	8,094	Mar 01	839
1991-92	*	*	*	*		*
1992-93	*	*	*	*		*
1993-94	47	0	N.D.	*		N.D.
1994-95	795	0	44.9	32,480	Jan 10	2,000
1995-96	638	0	8.9	6,474	Feb 21	1,100

M Data missing

* Record incomplete

E Estimate

N.D. Not determined

** Record not computed

+ Less than 0.05 acre feet or less than 0.05 cfs, but greater than 0

RUNOFF – STREAM GAGING STATION PEAK FLOW

**LITTLE ROCK CREEK above Little Rock Dam.
STATION NO. L1-R**

Season	Daily CFS			Total Runoff (Acre-feet)	Peak Flow	
	Maximum	Minimum	Mean		Date	CFS
1996-97	207	0	7.3	5,260	Jan 26	264
1997-98	1,610	0	52.3	37,890	Feb 23	3,470
1998-99	23	0	3.8	2,720	Feb 10	27
1999-00	168	0	6.9	5,000	Feb 23	519
2000-01	154	0	14.9	10,760	Mar 06	219
2001-02	3	0	0.6	305	Jan 29	4
2002-03	0	0	13.1	0	Feb 12	3,720
2003-04	173	0	4.7	3,370	Feb 26	473
2004-05	2,440	0	85.1	61,480	Jan 09	5,040
2005-06	330	0	17	8,620	Feb 28	786
2006-07	8	0	3.2	1,604	Feb 01	9
2007-08	578	0	14.8	10,709	Jan 27	1,427
2008-09	58	0	4.8	3,440	Feb 06	72
2009-10	282	0	16.6	12,030	Feb 06	551
2010-11	1,030	0	31.7	22,930	Dec 20	2,180
2011-12	35	0	4.5	3,270	Apr 18	40
2012-13	30	0	1.56	1,130	Jan 26	34
2013-14	23.4	0	0.94	684	Feb 28	214
2014-15	23.4	0	2.02	1470	Dec 12	74.4

M Data missing

* Record incomplete

E Estimate

N.D. Not determined

** Record not computed

+ Less than 0.05 acre feet or less than 0.05 cfs, but greater than 0

RUNOFF – STREAM GAGING STATION PEAK FLOW

**LIVE OAK CREEK below Live Oak Dam.
STATION NO. F356-R**

Season	Daily CFS			Total Runoff (Acre-feet)	Peak Flow	
	Maximum	Minimum	Mean		Date	CFS
1963-64	N.D.					
1964-65	3	0	0	14	Jun 24	78
1965-66	6	0	0.3	209	Mar 01	6
1966-67	44	0	0.9	671	Dec 06	194
1967-68	N.D.					
1968-69	N.D.					
1969-70	N.D.					
1970-71	N.D.					
1971-72	N.D.					
1972-73	N.D.					
1973-74	N.D.					
1974-75	5	0	0.1	78	Apr 08	5
1975-76	5	0	0	27	Apr 26	6
1976-77	2	0	0	31	Aug 17	4
1977-78	73	0	2.1	1,517	Mar 04	120
1978-79	4	0	0.9	656	Mar 30	5
1979-80	84	0	2.6	1,907	Feb 17	105
1980-81	3	0	0.3	219	Mar 03	4
1981-82	20	0	0.6	417	Mar 18	21
1982-83	45	0	0	1,780		
1983-84	2	0	0.6	450	Dec 05	3
1984-85	4	0	0.2	163		
1985-86	2	0	0.3	196	Mar 25	2
1986-87	1	0	0	38		
1987-88	6	0	0	69		
1988-89	5	0	0.1	94	Feb 14	8
1989-90	2	0	0.1	42	May 28	3
1990-91	4	0	0.3	200	Mar 04	5
1991-92	18	0	0.4	273	Feb 13	36
1992-93	48	0	2.4	1,706	Feb 22	80
1993-94	6	0	0.3	200	May 10	6
1994-95	30	0	1.5	1,058	Mar 06	103
1995-96	24	0	0.5	393	Feb 21	82

M Data missing

* Record incomplete

E Estimate

N.D. Not determined

** Record not computed

+ Less than 0.05 acre feet or less than 0.05 cfs, but greater than 0

RUNOFF – STREAM GAGING STATION PEAK FLOW

**LIVE OAK CREEK below Live Oak Dam.
STATION NO. F356-R**

Season	Daily CFS			Total Runoff (Acre-feet)	Peak Flow	
	Maximum	Minimum	Mean		Date	CFS
1996-97	7	0	0.5	349	Dec 17	25
1997-98	51*	0*	1.07*	773.87*	Feb 24	65
1998-99	9	0	0.1	104	Dec 08	30
1999-00	1.1*	0*	0.11*	77.85*	Jun 20	25
2000-01	20	0	0.2	120	Jul 10	61
2001-02	0	0	0	2	May 21	15
2002-03	5	0	0.7	49	Nov 19	19
2003-04	14	0	0.3	230	Mar 01	16
2004-05	156	0	4	2,920	Jan 09	210
2005-06	15	0.1	1.1	812	Oct 15	36
2006-07	4	0.1	1.7	994	May 01	34
2007-08	4	0	0.9	632	Oct 23	35
2008-09	8	0	0.4	314	Feb 10	9
2009-10	14	0	0.49	352	Apr 27	16
2010-11	14	0	1.08	781	Mar 28	18
2011-12	4	0	1.55	1,130	Apr 26	50
2012-13	1	0	0.21	150	May 26	1
2013-14	0.2	0	0.001	0.5	Jun 10	2.26
2014-15	0.64	0	0.018	13	Feb 23	1.17

M Data missing

* Record incomplete

E Estimate

N.D. Not determined

** Record not computed

+ Less than 0.05 acre feet or less than 0.05 cfs, but greater than 0

RUNOFF – STREAM GAGING STATION PEAK FLOW

**LOS ANGELES RIVER below Wardlow River Road.
STATION NO. F319-R**

Season	Daily CFS			Total Runoff (Acre-feet)	Peak Flow	
	Maximum	Minimum	Mean		Date	CFS
1928-29	N.D.	N.D.	N.D.	9,340E	Mar 10	2,870E
1929-30	1,270	0.9	17	12,310	Mar 15	1,670
1930-31	1,390	0	19.9	14,400	Feb 03	3,700
1931-32	7,130	0.8	70.2	50,960	Feb 09	8,380
1932-33	3,310	0.3	31.6	22,890	Jan 19	8,710
1933-34	19,900	0	93.7	67,860	Jan 01	37,500
1934-35	2,930	1.6	55.9	40,470	Apr 08	11,000
1935-36	1,630	2.3	28.3	20,470	Feb 12	10,400
1936-37	6,800	3.3	126	91,110	Feb 14	20,500
1937-38	50,000	1	564	408,000	Mar 02	99,000E
1938-39	6,220	3.5	114	82,750	Sep 25	17,300
1939-40	2,830E	15	90.8	65,930	Feb 02	8,440
1940-41	11,120	18	510	369,500	Mar 04	18,170
1941-42	3,180	31	129	93,390	Dec 10	10,800
1942-43	18,100	28	366	264,900	Jan 23	37,900
1943-44	17,190	38	299	217,400	Feb 22	34,000
1944-45	3,020	33	138	100,200	Nov 12	11,600
1945-46	6,440	30	127	91,790	Dec 22	12,800
1946-47	5,750	18	146	106,000	Dec 26	18,810
1947-48	1,540	19	72.8	52,820	Mar 24	9,310
1948-49	1,790	13	61.3	44,350	Dec 17	5,520
1949-50	2,360	6.3	58.3	42,180	Feb 06	9,090
1950-51	1,610	5.6	50.6	36,600	Jan 29	9,040
1951-52	16,310	3.8	292	212,200	Jan 16	47,800
1952-53	2,932	1.9	61.4	44,490	Nov 15	21,100
1953-54	8,120	2.5	97.8	70,790	Feb 13	34,760
1954-55	4,180	2.2	83	60,120	Jan 18	17,750
1955-56	12,700	7	133	96,810	Jan 26	40,500
1956-57	4,550	5.5	67.3	48,710	Feb 23	23,000
1957-58	10,400	6.4	264	191,200	Feb 19	43,800
1958-59	6,340	7.2	68.2	49,390	Jan 06	31,000
1959-60	3,420	3.7	67.6	49,100	Jan 12	21,700

M Data missing

* Record incomplete

E Estimate

N.D. Not determined

** Record not computed

+ Less than 0.05 acre feet or less than 0.05 cfs, but greater than 0

RUNOFF – STREAM GAGING STATION PEAK FLOW

**LOS ANGELES RIVER below Wardlow River Road.
STATION NO. F319-R**

Season	Daily CFS			Total Runoff (Acre-feet)	Peak Flow	
	Maximum	Minimum	Mean		Date	CFS
1960-61	2,860	1.3	44.2	32,000	Jan 26	9,450
1961-62	14,800	0.6	245	177,400	Feb 12	42,200
1962-63	5,480	1.2	75.6	54,700	Feb 09	31,400
1963-64	4,150	5.3	64.8	47,020	Jan 22	16,000
1964-65	5,150	4.1	106	76,680	Apr 09	30,100
1965-66	22,500	3	342	247,900	Dec 29	61,500
1966-67	12,400	9.9	237	171,900	Nov 07	43,700
1967-68	13,600	18	173	125,800	Mar 08	48,900
1968-69	55,000	16	1,150.00	832,000	Jan 25	102,000
1969-70	5,300	22	128	92,070	Feb 28	5,300
1970-71	20,600	20	201*	145,300*	Nov 29	65,100
1971-72	8,550	17	106	77,560	Dec 24	28,700
1972-73	16,170	20	253	183,300	Feb 11	50,800
1973-74	17,200	17	190	137,800	Jan 07	42,800
1974-75	11,200	13	159	115,000	Dec 04	64,470
1975-76	4,660	11.5	102	72,670	Feb 09	16,020
1976-77	7,130	5.3	140.4	101,700	Jan 03	29,528
1977-78	42,323	11	923	668,337	Feb 10	94,800
1978-79	13,000	33	379.2	274,500	Mar 27	50,900
1979-80	33,437	39	887.9	544,632	Feb 16	128,700
1980-81	6,550	27	173.2	125,893	Jan 29	33,800
1981-82	11,400	32	246.2	178,227	Apr 01	26,800
1982-83	52,000	38	1,047.00	758,465	Mar 01	81,800
1983-84	6,530	41	166.8	120,740	Dec 25	22,300
1984-85	6,370	34	1,970.00	118,440	Dec 19	23,500
1985-86	13,600	51.4	338	244,741	Feb 15	54,400
1986-87	4,050	92.6	164	118,510	Nov 18	15,500
1987-88	8,230	85	242.8	176,277	Dec 04	48,900
1988-89	3,740	101	195	141,249	Dec 16	16,900
1989-90	12,100	115	196	141,594	Feb 17	25,600
1990-91	10,700	108	310	224,410	Feb 28	42,400
1991-92	23,800	110	668	484,849	Feb 12	66,400

M Data missing

* Record incomplete

E Estimate

N.D. Not determined

** Record not computed

+ Less than 0.05 acre feet or less than 0.05 cfs, but greater than 0

RUNOFF – STREAM GAGING STATION PEAK FLOW

**LOS ANGELES RIVER below Wardlow River Road.
STATION NO. F319-R**

Season	Daily CFS			Total Runoff (Acre-feet)	Peak Flow	
	Maximum	Minimum	Mean		Date	CFS
1992-93	35,000	123	1,549.00	1,122,000	Feb 08	86,000
1993-94	4,090	113	259	187,400	Mar 24	19,700
1994-95	43,900	92.5	1,022.00	740,000	Mar 11	113,000
1995-96	15,100	96.8	261	189,200	Feb 21	35,400
1996-97	7,390	91	299	216,300	Dec 09	28,600
1997-98	*	*	*	*		*
1998-99	M	*	*			M
1999-00	477*	164.0*	203.0*	24,560*		N.D.
2000-01	12,700	116	405	293,500	Jan 11	54,400
2001-02	3,838	105.1	185.8	131,061	Nov 24	28,837
2002-03	19,959	68.4	317	229,041	Feb 12	58,000
2003-04	15,433	86.2	196	142,369	Feb 26	61,300
2004-05	44,900	76	1,274.00	922,000	Jan 09	71,500
2005-06	7,860	110	276	199,500	Jan 02	39,328
2006-07	3,460	105	151.2	109,493	Sep 22	11,301
2007-08	11,000	112	284.7	206,678	Jan 05	57,783
2008-09	6,420	110	207	149,700	Dec 15	30,200
2009-10	14,400	115	334	241,700	Feb 06	56,800
2010-11	16,100	92.7	429	310,500	Mar 20	36,800
2011-12	6,180	109	308	223,300	Nov 20	31,600
2012-13	4,570	102	327	236,900	Mar 08	18,100
2013-14	9,750	97.5	214	154,700	Jun 10	31,200
2014-15	8,230	106	248	179,500	Sep 15	30,000

M Data missing

* Record incomplete

E Estimate

N.D. Not determined

** Record not computed

+ Less than 0.05 acre feet or less than 0.05 cfs, but greater than 0

RUNOFF – STREAM GAGING STATION PEAK FLOW

**LOS ANGELES RIVER at Tujunga Avenue.
STATION NO. F300-R**

Season	Daily CFS			Total Runoff (Acre-feet)	Peak Flow	
	Maximum	Minimum	Mean		Date	CFS
1950-51	181	2.6	12.3	8,910	Jan 29	598
1951-52	5,360	3.1	101	73,040	Jan 15	13,200
1952-53	851	6.5	27.1	19,610	Dec 01	2,900
1953-54	1,360	4.6	27.2	19,690	Feb 13	5,190
1954-55	842	5.7	30.4	22,000	Jan 10	4,560
1955-56	3,890	5.7	35.1	25,490	Jan 16	6,800
1956-57	1,300	4.5	27.2	19,700	Jan 13	6,060
1957-58	3,530	3.8	100	72,710	Apr 03	10,800
1958-59	2,080	4.8	29.2	21,180	Jan 06	12,800
1959-60	1,040	4	28	20,650	Jan 12	6,900
1960-61	1,010	3.2	18.3	13,260	Nov 05	6,600
1961-62	6,170	2.6	97.7	70,690	Feb 12	21,000
1962-63	2,200	4	34.1	24,690	Feb 09	8,700
1963-64	1,440	3.6	35.4	25,730	Jan 22	7,910
1964-65	2,020	5	50.4	36,490	Apr 09	7,840
1965-66	8,990	8.2	126	91,340	Dec 29	20,500
1966-67	5,860	5.2	83.3	60,320	Nov 07	21,000
1967-68	5,720	5.5	66.8	48,500	Mar 08	18,300
1968-69	19,100	4.8	355	256,800	Jan 25	30,800
1969-70	2,450	6.4	55.4	40,080	Mar 04	11,600
1970-71	9,170	7	95.4	69,090	Nov 29	25,900
1971-72	2,800	7.8	38	27,520	Dec 27	11,000
1972-73	6,470	5.5	101	73,100	Jan 18	17,900
1973-74	7,650	5	73	52,830	Jan 07	16,100
1974-75	3,570	5	57.1	41,310	Dec 04	16,740
1975-76	2,440	3.7	35.5	25,200	Feb 09	9,680
1976-77	2,920	1.5	50.9	36,850	Jan 03	15,300
1977-78	19,200	0.8	454.6	329,106	Feb 10	30,100
1978-79	5,210	5.5	136	98,301	Mar 27	22,500
1979-80	9,440	8.4	284.9	202,020	Feb 16	27,625
1980-81	2,600	10	77.7	56,220	Jan 29	17,940
1981-82	3,610	5	72.7	52,648	Mar 17	17,800
1982-83	19,580	5.7	416.8	301,711	Mar 01	27,625

M Data missing

* Record incomplete

E Estimate

N.D. Not determined

** Record not computed

+ Less than 0.05 acre feet or less than 0.05 cfs, but greater than 0

RUNOFF – STREAM GAGING STATION PEAK FLOW

**LOS ANGELES RIVER at Tujunga Avenue.
STATION NO. F300-R**

Season	Daily CFS			Total Runoff (Acre-feet)	Peak Flow	
	Maximum	Minimum	Mean		Date	CFS
1983-84	NO RECORD					
1984-85	1,820	8.1	47.4	34,312	Dec 18	6,740
1985-86	3,060	20	126	91,248	Jan 31	16,700
1986-87	*	*	*	*		*
1987-88	3,850	31.7	164.4	118,911	Oct 22	24,300
1988-89	1,460	59.8	103.4	74,960	Dec 24	5,140
1989-90	2,910	55.6	93.5	67,699	Feb 17	7,296
1990-91	3,130	14.4	113.7	82,553	Feb 27	13,500
1991-92	10,800	33.7	239	173,398	Feb 11	22,300
1992-93	10,600	51.9	416	301,300	Feb 07	25,700
1993-94	2,390	54.7	133	96,020		N.D.
1994-95	10,800	53.7	252	167,800	Mar 10	35,000
1995-96	3,110	51	117	84,630	Feb 21	13,000
1996-97	2,590	53	156	112,700	Dec 09	12,300
1997-98	11,900	63	420	304,200	Feb 23	30,500
1998-99	1,200	35	85.1	61,630	Jan 31	9,320
1999-00	1,200	35	85.1	61,630	Feb 23	9,320
2000-01	2,790	47	134	97,450	Jan 11	17,200
2001-02	1,489	26.6	90.5	65,515	Nov 24	12,815
2002-03	10,976	43.3	187	135,474	Feb 12	25,000
2003-04	3,712	42.1	110	80,740	Feb 26	16,400
2004-05	15,800	35	582	421,000	Jan 09	25,300
2005-06	3,540	45	157	113,700	Jan 02	15,647
2006-07	3,720	48.4	93.3	67,538	Sep 22	21,748
2007-08	1,050	124	146.9	106,660	Jan 04	14,945
2008-09	2,200	31.9	94.3	68,300	Dec 15	10,400
2009-10	4,500	42.8	163	117,700	Feb 06	20,500
2010-11	10,600	42.9	240	173,700	Mar 20	29,300
2011-12	2,540	25.5	107	77,700	Apr 13	18,800
2012-13	1,790	32	108	78,400	Mar 08	8,670
2013-14	5,500	29.9	82.2	59,510	Feb 28	17,100
2014-15	3,100	22.3	94.7	68,560	Dec 12	11,900

M Data missing

* Record incomplete

E Estimate

N.D. Not determined

** Record not computed

+ Less than 0.05 acre feet or less than 0.05 cfs, but greater than 0

RUNOFF – STREAM GAGING STATION PEAK FLOW

LOS ANGELES RIVER above Arroyo Seco STATION NO. F57C-R

Season	Daily CFS			Total Runoff (Acre-feet)	Peak Flow	
	Maximum	Minimum	Mean		Date	CFS
1930-31	927	0	5.5	3,950	Feb 04	4,540
1931-32	2,520	0	21	15,240	Feb 08	3,020
1932-33	2,330	0	14.7	10,640	Jan 19	5,780
1933-34	5,990	0	41.2	29,810	Jan 01	22,000
1934-35	568	0.1	17.3	12,550	Apr 08	2,400E
1935-36	322	0.4	7.9	5,770	Mar 30	2,540
1936-37	1,670	0.4	33.8	24,470	Feb 06	2,410E
1937-38	27,900	0.6	183	132,600	Mar 02	68,000E
1938-39	1,950	3.8	58.5	42,360	Jan 05	3,710
1939-40	2,070	6	54.5	39,590	Jan 08	8,900
1940-41	6,700	4.2	228	165,000	Feb 20	11,900
1941-42	1,170	22	75.7	54,800	Dec 10	5,260
1942-43	7,120	15	172	124,400	Jan 23	23,900
1943-44	8,020	25	151	109,800	Feb 22	14,600
1944-45	1,160	6.5	51.1	36,990	Feb 02	4,900
1945-46	1,880	3.4	49.6	35,880	Dec 22	5,240
1946-47	896	1.6	43.3	31,330	Dec 25	5,320
1947-48	498	3.6	20.5	14,890	Mar 24	4,900
1948-49	451	4.2	24.3	17,600	Dec 17	1,530
1949-50	804	0.3	14.9	10,760	Feb 06	2,840
1950-51	487	0.5	10.8	7,840	Jan 11	3,600
1951-52	8,130	0.5	149	108,000	Jan 16	25,300
1952-53	1,370	0.6	25.5	18,480	Dec 20	7,270
1953-54	2,570	0.2	29	21,000	Feb 13	9,580
1954-55	1,510	0.2	25.2	18,270	Jan 18	6,850
1955-56	7,290	0.6	49.4	35,890	Jan 26	15,300
1956-57	2,390	0.2	34.4	24,890	Feb 23	22,200
1957-58	4,650	0.4	126	91,020	Feb 19	19,700
1958-59	3,790	0.2	27.6	20,230	Jan 06	17,200
1959-60	1,420	+	23.3	16,910	Jan 12	8,960
1960-61	1,690	+	16.6	12,000	Nov 05	7,890
1961-62	8,510	+	120	86,910	Feb 12	32,500
1962-63	3,750	+	32.4	23,440	Feb 09	18,100

M Data missing

* Record incomplete

E Estimate

N.D. Not determined

** Record not computed

+ Less than 0.05 acre feet or less than 0.05 cfs, but greater than 0

RUNOFF – STREAM GAGING STATION PEAK FLOW

LOS ANGELES RIVER above Arroyo Seco STATION NO. F57C-R

Season	Daily CFS			Total Runoff (Acre-feet)	Peak Flow	
	Maximum	Minimum	Mean		Date	CFS
1963-64	1,950	+	27.9	20,320	Jan 22	12,200
1964-65	2,880	+	49.1	35,580	Apr 09	12,500
1965-66	12,600	0.1	149	107,500	Dec 29	32,000
1966-67	7,720	0.4	115	82,210	Nov 07	32,100
1967-68	4,780	3.4	82.2	59,710	Mar 08	30,900
1968-69	23,400	4	425	307,400	Jan 25	41,800
1969-70	2,760	6.9	65.6	47,520	Mar 04	17,000
1970-71	12,900	7.4	129	93,310	Nov 29	41,500
1971-72	4,830	5.4	64.3	46,690	Dec 27	15,900
1972-73	9,190	6.7	157	114,000	Jan 18	28,230
1973-74	12,480	5.8	123	88,900	Jan 07	24,540
1974-75	5,750	4.2	88.6	64,120	Dec 04	27,570
1975-76	3,230	2.7	54.7	39,720	Feb 09	13,900
1976-77	4,710	1.6	91.2	66,020	Jan 03	23,300
1977-78	22,700	5.4	506.5	366,663	Feb 10	52,700
1978-79	6,240	18.8	192	139,101	Mar 27	25,800
1979-80	16,800	11	428.6	303,340	Feb 16	52,200
1980-81	3,340	14.9	104.9	75,932	Jan 29	28,200
1981-82	5,870	11	137.4	99,441	Mar 14	22,800
1982-83	25,100	22.2	560.4	405,695	Jan 27	44,500
1983-84	4,030	23	96.2	69,861	Dec 25	17,000
1984-85	3,380	30	98.3	71,160	Dec 19	9,270
1985-86	5,110	59	214.2	155,103	Jan 31	25,400
1986-87	2,090	70.2	101.5	73,480	Nov 17	13,000
1987-88	No Record					
1988-89	No Record					
1989-90	No Record					
1990-91	No Record					
1991-92	20,200	3.7	463	320,800	Feb 12	45,700
1992-93	*	*	*	*		*
1993-94	*	*	*	*		*
1994-95	19,900	114	*	*	Mar 10	44,900
1995-96	*	*	*	*		*

M Data missing

* Record incomplete

E Estimate

N.D. Not determined

** Record not computed

+ Less than 0.05 acre feet or less than 0.05 cfs, but greater than 0

RUNOFF – STREAM GAGING STATION PEAK FLOW

**LOS ANGELES RIVER above Arroyo Seco
STATION NO. F57C-R**

Season	Daily CFS			Total Runoff (Acre-feet)	Peak Flow	
	Maximum	Minimum	Mean		Date	CFS
1996-97	3,760	86	213	154,100	Dec 09	17,900
1997-98	13,900	88	479	346,700	Feb 23	37,800
1998-99	1,520	85	159	113,900	Jan 31	11,600
1999-00	4,370	82	196	142,200	Feb 23	25,200
2000-01	8,010	102	261	188,900	Jan 11	37,500
2001-02	2,543	65.1	166.7	120,659	Nov 24	20,272
2002-03	13,050	87.3	257	185,887	Feb 12	32,900
2003-04	6,564	90.2	187	135,871	Feb 26	28,100
2004-05	17,500	73	691	500,000	Feb 20	35,800
2005-06	5,820	66	217	156,800	Jan 02	25,329
2006-07	2,500	82	131.9	95,501	Sep 22	7,956
2007-08	6,830	57.3	243.4	176,715	Jan 04	27,092
2008-09	3,380	32.8	140	101,200	Feb 05	21,500
2009-10	5,890	68.6	215	155,700	Feb 06	32,500
2010-11	11,500	75.5	243	176,100	Mar 20	28,600
2011-12	2,680	46.1	150	108,900	Apr 13	22,200
2012-13	2,350	68.2	133	96,370	Mar 08	11,500
2013-14	6,130	69.8	140	101,400	Feb 28	6,810
2014-15	5,760	59.2	166	119,900	Sep 15	30,700

M Data missing

* Record incomplete

E Estimate

N.D. Not determined

** Record not computed

+ Less than 0.05 acre feet or less than 0.05 cfs, but greater than 0

RUNOFF – STREAM GAGING STATION PEAK FLOW

**MALIBU CREEK below Cold Creek.
STATION NO. F130-R**

Season	Daily CFS			Total Runoff (Acre-feet)	Peak Flow	
	Maximum	Minimum	Mean		Date	CFS
1930-31	*	*	*	1,920*	Feb 04	723
1931-32	1,770	+	20.2	14,670	Feb 09	3,100
1932-33	1,100	0.1	12.7	9,190	Jan 19	4,460
1933-34	3,160	0.1	17.1	12,370	Jan 01	9,650
1934-35	511	+	8.6	6,220		N.D.
1935-36	92	0	3.2	2,310	Feb 23	147
1936-37	1,680	0	33.1	23,940	Feb 14	2,760
1937-38	5,090E	0.2	47.1	34,100	Mar 02	10,000E
1938-39	139	0	6.4	4,630	Dec 20	331
1939-40	335	+	8.4	6,100	Feb 02	690
1940-41	2,200	0.1	101	73,220	Feb 20	3,620
1941-42	32	0.1	2.5	1,820	Dec 28	140
1942-43	5,370	0.1	65.8	47,600	Jan 22	12,200
1943-44	3,400	0.7	41.6	30,170	Feb 22	7,700
1944-45	210	0.2	5.8	4,240	Feb 02	516
1945-46	267	0.1	5.2	3,800	Mar 30	506
1946-47	142	0.1	5.3	3,820	Nov 13	980
1947-48	15	+	0.2	177	Mar 24	113
1948-49	1	+	0.1	90	May 18	1
1949-50	64	0	0.7	477	Feb 06	674
1950-51	0	0	0.1	56	Jan 11	3
1951-52	6,720	0	80.2	58,200	Mar 15	13,600
1952-53	81	+	4	2,940	Nov 15	322
1953-54	655	0.1	6.9	4,990	Feb 13	2,250
1954-55	16	0.1	1	758	Jan 18	45
1955-56	1,260	0.1	6.5	4,680	Jan 26	3,600
1956-57	12	+	0.6	444	Feb 23	46
1957-58	1,630	+	43.7	31,660	Apr 03	4,260
1958-59	114	0.1	2.1	1,510	Jan 06	3,180
1959-60	17	+	0.7	504	Apr 27	84
1960-61	2	+	0.1	99	Jan 26	8
1961-62	3,920	+	36.3	26,150	Feb 10	7,060
1962-63	24	+	1	701	Mar 16	104

M Data missing

* Record incomplete

E Estimate

N.D. Not determined

** Record not computed

+ Less than 0.05 acre feet or less than 0.05 cfs, but greater than 0

RUNOFF – STREAM GAGING STATION PEAK FLOW

**MALIBU CREEK below Cold Creek.
STATION NO. F130-R**

Season	Daily CFS			Total Runoff (Acre-feet)	Peak Flow	
	Maximum	Minimum	Mean		Date	CFS
1963-64	17	+	0.5	384	Jan 22	65
1964-65	148	+	2.2	1,560	Apr 09	521
1965-66	7,060	0.2	51.8	37,520	Dec 29	20,600
1966-67	2,710	0.9	35.5	25,700	Jan 24	10,200
1967-68	1,350	1	18.5	13,430	Mar 08	3,830
1968-69	24,200	1.4	166	119,900	Jan 25	33,800
1969-70	368	0.5	9.9	7,200	Mar 04	1,150
1970-71	1,480	1.2	23.7	17,300	Dec 19	7,390
1971-72	582	0.9	6	4,340	Dec 27	2,120
1972-73	3,340	0.8	35.1	25,400	Feb 11	7,480
1973-74	2,240	2.7	22	15,910	Jan 07	5,100
1974-75	519	2.3	15.2	11,020	Dec 04	2,670
1975-76	163	1.1	5.4	3,910	Feb 09	339
1976-77	315	1.1	6.9	4,980	Jan 07	597
1977-78	7,620	1.7	112.4	80,990	Mar 04	19,400
1978-79	1,220	2.3	46.4	33,408	Mar 27	4,420
1979-80	*	*	*	*	Feb 16	*
1980-81	357	1.7	13.5	9,832	Mar 05	910
1981-82	400	2.2	13.9	10,031	Mar 17	676
1982-83	7,720	2.7	121.8	88,148	Mar 01	24,200
1983-84	758	2.5	24.1	17,411	Dec 25	1,840
1984-85	588	0.9	16.6	12,002	Dec 19	880
1985-86	1,480	1.4	39.3	27,881	Feb 15	5,880
1986-87	216	0.5	8.6	6,236	Nov 18	653
1987-88	559	0.6	24	17,337	Feb 28	1,680
1988-89	257	1.6	12.3	8,876	Feb 09	441
1989-90	*	*	*	*		*
1990-91	982	0.8	20.5	14,872	Mar 19	3,150
1991-92	5,850	2	92.7	67,330	Feb 10	23,300
1992-93	*	*	*	*		*
1993-94	880	0.9	16.7	11,090	Feb 20	2,450
1994-95	4,530	3.1	97.8	68,700	Mar 11	15,700
1995-96	637	1.5	12.9	9,395	Feb 21	1,220

M Data missing

* Record incomplete

E Estimate

N.D. Not determined

** Record not computed

+ Less than 0.05 acre feet or less than 0.05 cfs, but greater than 0

RUNOFF – STREAM GAGING STATION PEAK FLOW

**MALIBU CREEK below Cold Creek.
STATION NO. F130-R**

Season	Daily CFS			Total Runoff (Acre-feet)	Peak Flow	
	Maximum	Minimum	Mean		Date	CFS
1996-97	807	3.2	43.1	31,180	Dec 09	1,800
1997-98	4,020	2.4	113	81,700	Feb 07	19,100
1998-99	134	2.8	10.3	7,430	Apr 11	761
1999-00	701	1.4	22.6	16,440	Feb 23	2,380
2000-01	3,950	0.6	53.8	38,920	Mar 06	10,900
2001-02	93	0.9	10.6	7,670	Nov 24	413
2002-03	1,979	1.9	25.9	18,761	Feb 12	5,410
2003-04	1,470	1.2	13	9,442	Feb 26	5,130
2004-05	7,330	1.3		103,000	Jan 09	12,700
2005-06	845	3.1	31.9	23,120	Jan 02	2,586
2006-07	80	0.7	10.1	7,309	Feb 22	189
2007-08	1,940	0.9	32.4	23,510	Jan 27	3,851
2008-09	521	0.8	13.4	9,710	Feb 16	1,350
2009-10	816	1.97	27	19,530	Jan 20	2,970
2010-11	2,010	1.94	40.8	29,530	Mar 20	6,490
2011-12	320	0.86	11.9	8,660	Apr 13	1,030
2012-13	148	0.95	8.14	5,890	Jan 24	296
2013-14	646	0.9	7.07	5,120	Feb 28	1,550
2014-15	554	1.26	9.36	6,780	Dec 12	2,130

M Data missing

* Record incomplete

E Estimate

N.D. Not determined

** Record not computed

+ Less than 0.05 acre feet or less than 0.05 cfs, but greater than 0

RUNOFF – STREAM GAGING STATION PEAK FLOW

**MESCAL CREEK at mouth of canyon.
STATION NO. F395-R**

Season	Daily CFS			Total Runoff (Acre-feet)	Peak Flow	
	Maximum	Minimum	Mean		Date	CFS
1982-83*	72	0	5.2	3,795	Mar 01	120
1983-84	17	0	2.6	1,905	Dec 25	35
1984-85	2	0	0.2	140	Dec 27	8
1985-86	41	0	1.1	794	Feb 15	115
1986-87	2	0	0.1	39	Mar 07	8
1987-88	5	0	0.4	325		
1988-89	4	0	0.2	121	Mar 04	16
1989-90*	4	0	0.1	27		
1990-91	21	0	8.4	512		
1991-92*	60	0	2.1	1,235		
1992-93*	153	0	11.4	4,538		
1993-94	NO RECORD					
1994-95	69	0	3	2,184	Mar 05	132
1995-96*	14	0	0.5	369	Apr 08	127
1996-97	17	0	0.4	264	Jan 26	40
1997-98	71	0	4.2	3,050	Feb 23	174
1998-99	1	0	0.1	104	Jul 14	3
1999-00*	2	0	0.2	124	Feb 21	4
2000-01	14	0	1.3	952	May 21	15
2001-02	1	0	0	1	Nov 24	8
2002-03	0	0	0.2	0	Sep 03	247
2003-04	4	0	0.1	75	Dec 25	23
2004-05	209	0	8.3	5,980	Jan 09	370
2005-06	11	0.1	1.7	1,130	Dec 31	121
2006-07	0	0	0.1	10	Oct 01	0
2007-08	138	0	8.9	6,430	Apr 03	139
2008-09	8	0	0.9	655	Jan 27	27
2009-10	24	0	1.96	1,420	Apr 06	28
2010-11	241	0	14	10,110	Dec 12	261
2011-12	6	0	1.2	869	Dec 07	6
2012-13	1	0	0.09	65	Nov 08	4
2013-14	9.14	0	0.25	181	Feb 28	36.8
2014-15	5.28	0	0.21	150	Jul 19	25.6

M Data missing

* Record incomplete

E Estimate

N.D. Not determined

** Record not computed

+ Less than 0.05 acre feet or less than 0.05 cfs, but greater than 0

RUNOFF – STREAM GAGING STATION PEAK FLOW

**MINT CANYON CREEK at Sierra Highway.
STATION NO. F328B-R**

Season	Daily CFS			Total Runoff (Acre-feet)	Peak Flow	
	Maximum	Minimum	Mean		Date	CFS
2003-04	9	0	0	51	Feb 26	20
2004-05	229	0	2.7	1,930	Jan 09	550
2005-06	13	0	0.2	97	Jan 02	155
2006-07	0	0	0.1	1	Feb 19	10
2007-08	31	0	0.2	131	Feb 17	150
2008-09	6	0	0.6	40	Dec 15	43
2009-10	12	0	0.11	82	Jan 18	148
2010-11	30	0	0.13	97	Mar 20	268
2011-12	11	0	0.043	31	Apr 13	249
2012-13	0	0	0	0.01	Oct 11	0.29
2013-14	7.71	0	0.029	21	Feb 28	155
2014-15	96.8	0	0.98	711	Sep 15	352

M Data missing

* Record incomplete

E Estimate

N.D. Not determined

** Record not computed

+ Less than 0.05 acre feet or less than 0.05 cfs, but greater than 0

RUNOFF – STREAM GAGING STATION PEAK FLOW

**MONTEBELLO STORM DRAIN above Rio Hondo.
STATION NO. F181-R**

Season	Daily CFS			Total Runoff (Acre-feet)	Peak Flow	
	Maximum	Minimum	Mean		Date	CFS
1931-32	*	0	*	1,120*	Jan 31	531
1932-33	125	0	0.8	529	Jan 19	713
1933-34	391	0	2.6	1,910	Jan 01	1,360
1934-35	114	0	2.3	1,650	Jan 05	1,140
1935-36	55	0	1.2	889	Feb 14	374
1936-37	NO RECORD					
1937-38	N.D.	N.D.	N.D.	N.D.	Mar 02	1,400E
1938-39	147	0	1.4	981	Sep 25	688
1939-40	77	0.1	1.2	885	Feb 01	729
1940-41	204	0.1	5.6	4,090	Mar 03	936
1941-42	102	0.1	1.3	962	Dec 10	521
1942-43	300E	0.1	3.6	2,580		N.D.
1943-44	323E	0.1	3.3	2,390	Feb 22	1,040
1944-45	64	0.1E	0.8	768	Nov 11	506
1945-46	92	0	1.2	865	Dec 22	384
1946-47	144	0.1	1.9	1,350	Nov 13	1,240
1947-48	86	0.1	1.3	913	Dec 05	1,220
1948-49	41	0.1	1.2	861	Dec 17	347
1949-50	95	0.1	1.7	1,240	Jan 08	790
1950-51	50	0.1	1.2	888	Jan 10	333
1951-52	302	0.1	4.6	3,330	Mar 07	1,010
1952-53	97	0.1	2	1,430	Nov 15	770
1953-54	232	0.1	3	2,190	Feb 13	1,010
1954-55	*	*	*	1,210*	Jan 18	759
1955-56	463	+	2.9	2,110	Jan 26	856
1956-57	65	+	1.6	1,120	Feb 28	570
1957-58	199	+	4.5	3,250	Feb 19	865
1958-59	109	0.1	1.7	1,230	Jan 06	869
1959-60	96	0.1	2.1	1,530	Jan 12	784
1960-61	65	0.1	1.2	884	Nov 26	478
1961-62	225	0.1	4.6	3,370	Feb 12	783
1962-63	129	0.3	2.1	1,530	Mar 16	851
1963-64	77	0.2	1.8	1,280	Nov 19	553

M Data missing

* Record incomplete

E Estimate

N.D. Not determined

** Record not computed

+ Less than 0.05 acre feet or less than 0.05 cfs, but greater than 0

RUNOFF – STREAM GAGING STATION PEAK FLOW

**MONTEBELLO STORM DRAIN above Rio Hondo.
STATION NO. F181-R**

Season	Daily CFS			Total Runoff (Acre-feet)	Peak Flow	
	Maximum	Minimum	Mean		Date	CFS
1964-65	124	+	2.7	1,970	Apr 09	844
1965-66	281	0.1	4.4	3,200	Dec 29	904
1966-67	288	0.2	4.9	3,560	Jan 24	1,060
1967-68	198	0.2	2.9	2,130	Mar 08	923
1968-69	424	0.2	8.5	6,165	Jan 25	1,600E
1969-70	135	+	2.4	1,740	Feb 10	792
1970-71	169	+	2.8	2,000	Nov 29	833
1971-72	142	0.2	1.6	1,160	Dec 24	637
1972-73	140	0.1	3.8	2,740	Feb 27	811
1973-74	128	+	1.4	988	Jan 07	546
1974-75	61	+	1	748	Dec 04	608
1975-76	39	+	0.8	603	Sep 11	240
1976-77	36	0	0.7	490	May 08	226
1977-78	318	0	4.2	3,050	Jan 16	991
1978-79	107	0	1.7	1,239	Mar 27	619
1979-80	809	0	9.6	6,759		N.D.
1980-81	53	0	0.7	515	Mar 02	293
1981-82	62	0	1	728	Nov 28	341
1982-83	630	0	6	4,319	Mar 01	1,620
1983-84	32	0	6	455	Oct 01	506
1984-85	44	0	0.9	644	Dec 19	469
1985-86	78	0	1.4	1,327	Feb 14	676
1986-87	39	0	0.5	391	Oct 02	520
1987-88	81	0	1.1	775	Jan 17	493
1988-89	30	0.1	1	726	Dec 21	255
1989-90	110	0.1	1.1	767	Feb 17	500
1990-91	75	0	1.3	907	Feb 27	486
1991-92	183	0.1	2.2	1,565	Feb 12	1,020
1992-93	204	0	4.6	3,364	Dec 07	1,040
1993-94	48	0	0.7	536	Mar 19	542
1994-95	131	0	4	2,896	Jan 10	1,340
1995-96	134	0	1.1	792	Feb 20	899
1996-97	35	0	1	745	Jan 15	290

M Data missing

* Record incomplete

E Estimate

N.D. Not determined

** Record not computed

+ Less than 0.05 acre feet or less than 0.05 cfs, but greater than 0

RUNOFF – STREAM GAGING STATION PEAK FLOW

**MONTEBELLO STORM DRAIN above Rio Hondo.
STATION NO. F181-R**

Season	Daily CFS			Total Runoff (Acre-feet)	Peak Flow	
	Maximum	Minimum	Mean		Date	CFS
1997-98	60	+	1.7	1,230	Feb 06	658
1998-99	26	0	0.5	358	Nov 28	214
1999-00	124	0.1	1.8	1,270	Feb 23	254
2000-01	66	+	1.5	1,060	Jan 12	641
2001-02	30	0	0.4	298	Nov 24	472
2002-03	129	0	1.4	1,037	Feb 12	644
2003-04	65	0	0.9	643	Feb 25	663
2004-05	82	0.1	1	720	Jan 09	190
2005-06	43	0.2	0.6	423	Feb 07	56
2006-07	1	0.2	0.2	146	Apr 20	17
2007-08	15	0.2	0.3	208	Jan 05	126
2008-09	2	0	0.2	160	Feb 05	22
2009-10	31	0	0.82	595	Apr 11	45
2010-11	67	0.09	0.87	633	Jan 30	194
2011-12	2	0.09	0.17	124	Mar 17	24
2012-13	22	0.58	1.48	1,070	Oct 11	35
2013-14	6.58	0	0.61	442	Feb 28	28.5
2014-15	12.5	0	0.5	366	Dec 12	25.1

M Data missing

* Record incomplete

E Estimate

N.D. Not determined

** Record not computed

+ Less than 0.05 acre feet or less than 0.05 cfs, but greater than 0

RUNOFF – STREAM GAGING STATION PEAK FLOW

**PACOIMA CREEK below Pacoima Dam.
STATION NO. F118C-R**

Season	Daily CFS			Total Runoff (Acre-feet)	Peak Flow	
	Maximum	Minimum	Mean		Date	CFS
2011-12	76	0	4.43	2,440	May 08	296
2012-13	53	0	0.59	428	Apr 30	247
2013-14	84.4	0	0.76	549	Oct 24	416
2014-15	9.0	0	0.043	31	Apr 28	355

M Data missing

* Record incomplete

E Estimate

N.D. Not determined

** Record not computed

+ Less than 0.05 acre feet or less than 0.05 cfs, but greater than 0

RUNOFF – STREAM GAGING STATION PEAK FLOW

**PACOIMA DIVERSION at Branford Street.
STATION NO. F305-R**

Season	Daily CFS			Total Runoff (Acre-feet)	Peak Flow	
	Maximum	Minimum	Mean		Date	CFS
1953-54	116	0	1.4	976	Feb 13	508
1954-55	53	0	1.2	872	May 07	450
1955-56	194	0	1.6	1,123	Jan 26	622
1956-57	57	0	1.2	842	Jan 13	580
1957-58	326	0	8.9	6,390	Feb 04	1,380
1958-59	163	0	1	691	Jan 06	2,800
1959-60	46	0	1	690	Jan 11	666
1960-61	86	0	1.3	910	Nov 05	988
1961-62	104	0	1.4	988	Feb 11	2,960
1962-63	78	0	1.2	883	Apr 25	988
1963-64	150	0	1.5	1,116	Jan 22	2,550
1964-65	62	0	1.7	1,206	Apr 09	946
1965-66	614	0	8.6	6,144	Nov 17	4,800
1966-67	312	0	6.3	4,562	Jan 22	3,140
1967-68	N.D.					
1968-69	N.D.					
1969-70	N.D.					
1970-71	N.D.					
1971-72	N.D.					
1972-73	N.D.					
1973-74	N.D.					
1974-75	136	0.6	4.1	2,960	Mar 06	1,590
1975-76	107	0.7	2.8	2,039	Sep 05	2,580
1976-77	135	0.5	2.7	1,978	Jan 03	2,860
1977-78	3,200	0.6	704.1	42,306	Mar 04	3,730
1978-79	214	0.7	6.4	4,629	Mar 28	4,090
1979-80	1,180	0.6	8.3	17,148		
1980-81	162	0	3	2,146	Jan 29	3,790
1981-82	250	0.2	3.7	2,709	Mar 17	4,660
1982-83	4,280	0	60.8	44,045	Mar 01	10,900
1983-84	69	0	2.6	1,921	Oct 04	896
1984-85	65	0.1	1.5	1,104	Dec 18	1,270
1985-86	134	0	3.2	2,280	Jan 31	2,230

M Data missing

* Record incomplete

E Estimate

N.D. Not determined

** Record not computed

+ Less than 0.05 acre feet or less than 0.05 cfs, but greater than 0

RUNOFF – STREAM GAGING STATION PEAK FLOW

**PACOIMA DIVERSION at Branford Street.
STATION NO. F305-R**

Season	Daily CFS			Total Runoff (Acre-feet)	Peak Flow	
	Maximum	Minimum	Mean		Date	CFS
1986-87	141	0	2.9	2,119	Nov 17	2,260
1987-88	388	0.2	4.9	3,593	Oct 22	7,470
1988-89	772	0.7	3.6	2,639	Nov 14	740
1989-90	78	0.8	2.8	2,051	Feb 04	1,050
1990-91	M	M	M	M		M
1991-92	1,130	0.7	16.8	12,188	Feb 04	9,700
1992-93	1,420	0.5	55.3	40,071	Dec 07	6,470
1993-94	154	0.7	4.9	3,531	Dec 11	3,190
1994-95	1,250	0	18.8	13,621	Mar 10	7,250
1995-96	364	0.4	5.5	4,021	Feb 21	3,700
1996-97	225	1.3	7	5,052	Dec 22	4,700
1997-98	1,460	1	34.5	25,007	Feb 07	13,600
1998-99	108	1.8	6.4	4,622	Oct 29	3,350
1999-00*	169	2.3	6.1	4,390	Feb 20	3,740
2000-01	305	1.3	7	5,030	Jan 11	6,130
2001-02	167	0.9	3.2	2,316	Nov 24	5,895
2002-03	704	0.7	7.9	5,706	Dec 16	6,060
2003-04	215	0.2	2.9	2,100	Feb 26	2,260
2004-05	3,440	0.1	57.1	41,400	Jan 09	10,100
2005-06	100	0.9	4.2	3,020	Apr 01	1,560
2006-07	120	0.9	3.4	2,462	Sep 22	2,186
2007-08	345	0.9	7.4	5,390	Jan 04	2,082
2008-09	225	0	3.7	2,710	Nov 26	2,620
2009-10	410	0.53	8.1	5,870	Jan 20	4,510
2010-11	908	0.69	20.1	14,580	Mar 20	8,970
2011-12	220	0.22	3.6	2,610	Apr 13	6,630
2012-13	59	0.14	1.8	1,300	Mar 08	1,270
2013-14	258	0	1.69	1,220	Feb 28	1,690
2014-15	160	0	1.95	1,410	Dec 12	1,690

M Data missing

* Record incomplete

E Estimate

N.D. Not determined

** Record not computed

+ Less than 0.05 acre feet or less than 0.05 cfs, but greater than 0

RUNOFF – STREAM GAGING STATION PEAK FLOW

**PALLETT CREEK at Valyermo Highway.
STATION NO. F122-R**

Season	Daily CFS			Total Runoff (Acre-feet)	Peak Flow	
	Maximum	Minimum	Mean		Date	CFS
1961-62	92	0	0.4	311	Feb 11	259
1962-63	1	0	0.3	190	Feb 09	3
1963-64	0	0	0	0		0
1964-65	0	0	+	1	Aug 12	16
1965-66	53	0	1.5	1,110	Dec 29	176
1966-67	4	0.3	0.8	618	Dec 06	7
1967-68	5	0.3	0.8	615	Nov 21	10
1968-69	770	0.3	7.8	5,640	Feb 25	1,480
1969-70	37	0.6	1.2	846	Feb 28	161
1970-71	183	0.1	1	744	Nov 29	839
1971-72	56	0.1	0.6	452	Dec 25	282
1972-73	7	+	0.2	156	Feb 11	24
1973-74	1	0.1	0.3	213	Dec 11	1
1974-75	2	0	0.2	140	Dec 04	10
1975-76	3	0	0.1	87	Sep 24	51
1976-77	3	0	0.1	39	May 08	10
1977-78	1,220	0	33.4	24,170	Feb 10	1,630
1978-79	156	0.6	5.9	4,312	Mar 29	191
1979-80	210	0	7.6	5,487	Feb 16	1,470
1980-81	16	0	1.7	1,193	Mar 01	60
1981-82	13	0	0.6	423	Apr 11	49
1982-83	454	0	11.9	8,626	Mar 01	831
1983-84	15	0.2	1.8	1,282	Jul 30	147
1984-85	12	0	0.4	292	Dec 27	14
1985-86	37	0	0.9	622	Jan 30	124
1986-87	2	0	0.4	264	Feb 25	3
1987-88	22	0	0.3	245		N.D.
1988-89	1	0	0.1	105	Dec 16	1
1989-90	0	0	0	0		0
1990-91	0	0	0	0		0
1991-92	240	0	4.9	3,570	Feb 12	670
1992-93	498	0.4	15.2	10,980	Feb 24	621
1993-94	2	0.2	1	645		N.D.

M Data missing

* Record incomplete

E Estimate

N.D. Not determined

** Record not computed

+ Less than 0.05 acre feet or less than 0.05 cfs, but greater than 0

RUNOFF – STREAM GAGING STATION PEAK FLOW

**PALLETT CREEK at Valyermo Highway.
STATION NO. F122-R**

Season	Daily CFS			Total Runoff (Acre-feet)	Peak Flow	
	Maximum	Minimum	Mean		Date	CFS
1994-95	133	0	6.8	4,934	Mar 11	579
1995-96	2	0	0.7	534	Jul 24	14
1996-97	0	0	0.1	90	Feb 08	0
1997-98	47	0	5.1	3,680	Feb 23	231
1998-99	3	0.1	0.9	655	Nov 28	6
1999-00	9	0	0.2	115	Feb 20	76
2000-01	4	0	0.7	513	Jan 02	45
2001-02	1	0	0.3	223	Nov 12	1
2002-03	0	0	0.2	0	Feb 12	65
2003-04	3	0	0.2	126	Feb 26	15
2004-05	300	0	12.7	9,160	Jan 09	1,330
2005-06	20	1.4	2.5	1,700	Feb 28	50
2006-07	2	0.1	1.3	682	Oct 05	2
2007-08	115	0	1.6	1,186	Jan 27	207
2008-09	5	+	0.8	580	Oct 06	5
2009-10	9	0	1.3	954	Jan 21	27
2010-11	249	1.24	5.48	3,960	Dec 22	402
2011-12	44	0	1.37	997	Sep 09	487
2012-13	5	0	0.028	20	Oct 11	12
2013-14	109	0	0.48	347	Feb 28	337
2014-15	3	0	0.009	7	Jul 30	59

M Data missing

* Record incomplete

E Estimate

N.D. Not determined

** Record not computed

+ Less than 0.05 acre feet or less than 0.05 cfs, but greater than 0

RUNOFF – STREAM GAGING STATION PEAK FLOW

**RIO HONDO above Stuart and Gray Road.
STATION NO. F45B-R**

Season	Daily CFS			Total Runoff (Acre-feet)	Peak Flow	
	Maximum	Minimum	Mean		Date	CFS
1927-28	*	0	*	269*	Mar 06	4*
1928-29	248	0	3.4	2,460	Apr 04	912
1929-30	285	0	2.8	2,000	Mar 15	743
1930-31	335	0	2.6	1,900	Feb 04	841
1931-32	3,440	0	27.4	19,920	Feb 09	4,610
1932-33	971	0	6.2	4,450	Jan 19	2,730
1933-34	5,810	0	23.5	17,030	Jan 01	16,000
1934-35	667	0	8.3	6,000	Apr 08	3,450
1935-36	472	0	5.8	4,220	Feb 12	3,160
1936-37	1,460	0	37.1	26,870	Feb 14	4,800
1937-38	12,700	0	238	172,100	Mar 03	24,400E
1938-39	910	0	13.2	9,540	Dec 18	5,260
1939-40	442	0	6.7	4,850	Jan 08	1,930
1940-41	3,690	0	129	93,260	Mar 04	6,420
1941-42	564	0	9.3	6,730	Dec 10	4,240
1942-43	4,660	0	57.9	41,910	Jan 23	11,800
1943-44	2,570E	0	36.9	26,820	Feb 22	6,670
1944-45	492	0	11.7	8,460	Nov 11	4,500
1945-46	1,130	0	15.6	11,280	Dec 22	4,270
1946-47	923	0	22.1	16,030	Nov 13	5,950
1947-48	425	0	4.8	3,510	Mar 24	2,880
1948-49	268	0	2.1	1,490	Jan 20	713
1949-50	402	0	3.9	2,840	Jan 08	1,790
1950-51	135	0	1.1	781	Jan 29	1,080
1951-52	2,430	0	35.9	26,040	Jan 16	9,040
1952-53	571	0	4.8	3,450	Nov 15	4,600
1953-54	1,780	0	14.9	10,760	Feb 13	8,860
1954-55	753	0	11.1	8,000	Jan 18	4,160
1955-56	4,910	0	20	14,540	Jan 26	11,600
1956-57	967	0	6.4	4,640	Feb 23	6,560
1957-58	2,230	0	41.8	30,260	Feb 19	10,800
1958-59	915	0	5.4	3,900	Jan 06	11,000

M Data missing

* Record incomplete

E Estimate

N.D. Not determined

** Record not computed

+ Less than 0.05 acre feet or less than 0.05 cfs, but greater than 0

RUNOFF – STREAM GAGING STATION PEAK FLOW

**RIO HONDO above Stuart and Gray Road.
STATION NO. F45B-R**

Season	Daily CFS			Total Runoff (Acre-feet)	Peak Flow	
	Maximum	Minimum	Mean		Date	CFS
1959-60	219	0	3.3	2,370	Jan 12	3,030
1960-61	115	0	1.2	831	Nov 26	2,090
1961-62	2,080	0	31.4	22,780	Feb 19	7,100
1962-63	620	0	4.5	3,280	Feb 09	4,240
1963-64	190	0	2.4	1,730	Jan 22	2,060
1964-65	1,130	0	7.3	5,310	Apr 09	8,780
1965-66	4,810	+	95.8	69,390	Dec 29	19,000
1966-67	5,210	+	26.6	21,530	Jan 24	20,100
1967-68	4,300	+	25.3	18,360	Mar 08	17,900
1968-69	23,100	+	424	307,100	Jan 25	46,900
1969-70	964	+	10	7,220	Feb 28	7,540
1970-71	2,430	+	13.1	9,520	Nov 29	9,350
1971-72	2,420	+	6	4,409	Dec 24	11,400
1972-73	2,550	+	21.9	15,860	Feb 11	15,180
1973-74	3,360	+	15.4	11,180	Jan 07	11,710
1974-75	303	+	9.5	6,910	Dec 04	13,250
1975-76	920	+	9.4	6,660	Sep 11	9,820
1976-77	619	0	6.9	5,020	Oct 23	2,890
1977-78	13,800	+	270	195,463	Mar 01	32,000
1978-79	4,600	0.5	46.5	33,662	Mar 27	25,600
1979-80	16,000	0.5	313.4	221,877	Feb 16	48,100
1980-81	2,050	0	13.2	9,539	Mar 01	13,500
1981-82	4,410	0	28.7	20,768	Nov 28	17,100
1982-83	20,600	0	236.5	172,592	Mar 01	38,400
1983-84	2,600	0	17.2	12,502	Oct 01	9,480
1984-85	1,400	0	14.1	10,216	Feb 09	7,130
1985-86	4,500	0	*	*	Feb 15	19,400
1986-87	1,730	0.1	8.6	6,256	Jan 04	10,000
1987-88	2,660	0	16.7	12,111	Jan 17	11,300
1988-89	1,280	0.1	12.4	8,967	Dec 21	6,050
1989-90	5,030	0.1	16.9	12,222	Feb 17	17,500
1990-91	3,880	0	34.1	24,720	Feb 27	19,600

M Data missing

* Record incomplete

E Estimate

N.D. Not determined

** Record not computed

+ Less than 0.05 acre feet or less than 0.05 cfs, but greater than 0

RUNOFF – STREAM GAGING STATION PEAK FLOW

**RIO HONDO above Stuart and Gray Road.
STATION NO. F45B-R**

Season	Daily CFS			Total Runoff (Acre-feet)	Peak Flow	
	Maximum	Minimum	Mean		Date	CFS
1991-92	6,930	0.1	56.7	41,160	Feb 12	32,000
1992-93	11,200	0	386	279,400	Feb 18	32,800
1993-94	260	0	10	7,222	Mar 19	4,240
1994-95	10,500	0.1	164	119,100	Jan 10	37,400
1995-96	6,320	0	40.3	29,240	Feb 20	20,200
1996-97	3,420	0.1	30.7	22,230	Jan 25	13,300
1997-98	9,700	0	178	129,200	Feb 08	34,700
1998-99	417	0	3.9	2,850	Nov 08	2,360
1999-00	2,960	+	*	*	Feb 23	14,600
2000-01	Under	Construct	since	May 2000.		
2001-02	*	*	*	*	Mar 17	421
2002-03	4,490	0	49.9	36,130	Sep 29	52
2003-04	4,756	0	20	14,410	Feb 26	25,100
2004-05	22,400	0	424	307,000	Jan 09	41,600
2005-06	2,140	0	9.7	7,010	Jan 02	4,280
2006-07	262	0	1.5	1,066	Sep 22	1,348
2007-08	2,750	0	25	18,162	Jan 05	6,780
2008-09	598	+	6.8	4,930	Dec 15	1,910
2009-10	4,030	0	30.5	22,060	Feb 06	7,600
2010-11	7,150	0	72.3	52,310	Dec 20	28,800
2011-12	1,930	0	10.6	7,670	Oct 05	8,600
2012-13	339	0	4.01	2,910	Oct 11	2,260
2013-14	277	0	2.06	1,490	Feb 28	1,460
2014-15	241	0	2.66	1,920	Dec 02	3,030

M Data missing

* Record incomplete

E Estimate

N.D. Not determined

** Record not computed

+ Less than 0.05 acre feet or less than 0.05 cfs, but greater than 0

RUNOFF – STREAM GAGING STATION PEAK FLOW

**RIO HONDO below Lower Azusa Avenue.
STATION NO. F192B-R**

Season	Daily CFS			Total Runoff (Acre-feet)	Peak Flow	
	Maximum	Minimum	Mean		Date	CFS
1931-32	*	*	*	12,710*		N.D.
1932-33	937	0	5.2	3,800	Jan 20	5,160
1933-34	2,700	0	11.2	8,110	Jan 01	5,860
1934-35	324	0	11.3	8,160	Apr 08	604
1935-36	114	0	4.7	3,400	Feb 11	391
1936-37	904	0	38.6	27,960	Feb 20	1,030
1937-38	10,500	0	241	174,300	Mar 02	31,000
1938-39	191	0	2.2	1,570	Jan 05	680
1939-40	224	0	5	3,640	Jan 07	288
1940-41	2,220	0	113	81,450	Mar 04	4,000
1941-42	214	0.1	2.7	1,980	Dec 10	254
1942-43	1,300	0	14.7	10,680	Jan 23	3,500
1943-44	502	0.3	15.9	11,600	Feb 22	1,080
1944-45	112	0.1	1.9	1,380	Nov 11	1,060
1945-46	267	0	18	13,030	Dec 23	483
1946-47	279	0	11.8	8,560	Nov 27	283
1947-48	570	0	7.2	5,250	Jun 07	584
1948-49	5	0	0.1	71	Feb 27	50
1949-50	24	0	0.3	203	Dec 18	124
1950-51	24	0	0.3	234	Jan 11	636
1951-52	753	0	8.7	6,340	Jan 16	2,180
1952-53	785	0	9	6,550	Nov 15	944
1953-54	654	0	14.9	10,800	Feb 13	1,740
1954-55	184	0	2	1,460	Jan 18	2,340
1955-56	1,020	0	4	2,940	Jan 26	3,030
1956-57	390	0	5.9	4,280	Feb 23	2,270
1957-58	735	0	32.6	23,610*	Feb 19	1,530
1958-59	218	0	1.8	1,290*	Jan 06	1,530
1959-60	30	0	0.4	303	Jan 12	185
1960-61	16	0	0.2	131	Nov 05	132
1961-62	630	0	13.1	9,460	Feb 12	856
1962-63	28	0	0.3	221	Mar 16	182
1963-64	22	0	0.3	187	Jan 21	296

M Data missing

* Record incomplete

E Estimate

N.D. Not determined

** Record not computed

+ Less than 0.05 acre feet or less than 0.05 cfs, but greater than 0

RUNOFF – STREAM GAGING STATION PEAK FLOW

**RIO HONDO below Lower Azusa Avenue.
STATION NO. F192B-R**

Season	Daily CFS			Total Runoff (Acre-feet)	Peak Flow	
	Maximum	Minimum	Mean		Date	CFS
1964-65	32	0	0.5	340	Apr 09	397
1965-66	261	0	7.7	5,570	Nov 24	1,440
1966-67	175	0	14.7	10,620	Jan 22	438
1967-68	61	0	0.8	576	Mar 08	714
1968-69	4,380	0	100	72,550	Jan 25	10,600
1969-70	251	0	5	3,580	Mar 04	1,160
1970-71	95	0	4.2	3,060	Nov 29	446
1971-72	5	0	0.3	210	Dec 24	266
1972-73	270	0	14.5	10,520	Feb 27	2,390
1973-74	144	0	5.1	3,720	Jan 07	196
1974-75	54	+	0.7	538	Dec 04	643
1975-76	34	0	0.5	345	Sep 11	635
1976-77	23	0	0.5	393	May 09	230
1977-78	1,910	0	84.7	61,288	Mar 01	3,210
1978-79	163	0	19.7	14,291	Feb 21	311
1979-80	1,490	0	77.5	55,368	Feb 16	3,050
1980-81	237	0	17.8	13,060	Dec 16	3,070
1981-82	196	0	11.5	8,293	Sep 23	342
1982-83	350	0	66.3	48,030	Apr 18	350
1983-84	251	0	15.5	11,194	Nov 01	303
1984-85	13	0	0.2	175	Nov 08	216
1985-86	318	0	36.7	26,570	Feb 15	357
1986-87	25	0	0.2	171	Jan 04	296
1987-88	223	0	5.9	4,290	Dec 04	350
1988-89	13	0	2.8	173	Dec 15	109
1989-90	46	0	0.4	259	Feb 17	236
1990-91	388	0	11.3	7,831	Aug 01	356
1991-92	809	0	25.4	18,429	Feb 13	3,860
1992-93	1,010	0	65.6	47,470	Feb 19	3,190
1993-94	47	0	2.4	1,748	Dec 14	272
1994-95	803	0	33.8	24,500	Mar 11	3,210
1995-96	665	0	29.1	21,100	Feb 21	1,400
1996-97	250	0	15.8	11,400	Jan 26	634

M Data missing

* Record incomplete

E Estimate

N.D. Not determined

** Record not computed

+ Less than 0.05 acre feet or less than 0.05 cfs, but greater than 0

RUNOFF – STREAM GAGING STATION PEAK FLOW

**RIO HONDO below Lower Azusa Avenue.
STATION NO. F192B-R**

Season	Daily CFS			Total Runoff (Acre-feet)	Peak Flow	
	Maximum	Minimum	Mean		Date	CFS
1997-98	1,270	0	35.4	25,610	Feb 07	3,670
1998-99	125	0	3.2	2,290	Nov 08	348
1999-00	33	0	0.6	455	Apr 17	348
2000-01	37	0	0.5	391	Jan 11	318
2001-02	104	0	2.6	1,794	Nov 24	1,035
2002-03	81	0	1.4	981	Dec 16	565
2003-04	62	0	1.5	1,121	Feb 26	437
2004-05	1,310	0	88	63,700	Feb 19	4,350
2005-06	212	0	9.2	6,660	Oct 17	538
2006-07	215	0	4.1	1,869	Feb 11	661
2007-08	203	0	9.2	6,678	Jan 27	1,076
2008-09	281	0	7.7	5,550	Feb 05	462
2009-10	75	0	3.7	2,700	Feb 06	479
2010-11	712	0	55.6	40,260	Dec 20	1,800
2011-12	309	0	14	10,170	Nov 06	565
2012-13	11	0	0.23	168	Mar 08	161
2013-14	30.5	0	0.2	144	Mar 01	222
2014-15	24.6	0	0.31	222	Dec 12	389

M Data missing

* Record incomplete

E Estimate

N.D. Not determined

** Record not computed

+ Less than 0.05 acre feet or less than 0.05 cfs, but greater than 0

RUNOFF – STREAM GAGING STATION PEAK FLOW

RIO HONDO BYPASS CHANNEL above Whittier Narrows STATION NO. F313B-R

Season	Daily CFS			Total Runoff (Acre-feet)	Peak Flow	
	Maximum	Minimum	Mean		Date	CFS
1953-54	138	0	12	7,233		
1954-55	169	0	19.6	9,750		
1955-56	172	0	23.5	14,984		
1956-57	168	0	27.5	19,965		
1957-58	175	0	18.4	13,371		
1958-59	N.D.					
1959-60	N.D.					
1960-61	N.D.					
1961-62	153	0	44.3	31,825		
1962-63	137	0	12.5	9,121		
1963-64	N.D.					
1964-65	N.D.					
1965-66	N.D.					
1966-67	N.D.					
1967-68	N.D.					
1968-69	N.D.					
1969-70	N.D.					
1970-71	N.D.					
1971-72	N.D.					
1972-73	N.D.					
1973-74	N.D.					
1974-75	145	0	46.8	33,880		
1975-76	169	0	27.1	19,670		
1976-77	138	0	7.8	5,641	Jan 05	182
1977-78	165	0	33.5	24,288	Sep 05	188
1978-79	184	0	63.6	46,015	Aug 04	187
1979-80	165	0	24.1	17,524	Oct 20	188
1980-81	134	0	67.9	49,193	Jan 11	185
1981-82	127	0	31.4	22,760	Oct 01	161
1982-83	92	0	7.9	5,750	Jan 16	93
1983-84	85	0	14.4	4,341	Dec 16	110
1984-85	150	0	52.5	38,014	Mar 27	185
1985-86	183	0	16.5	11,946	Jan 25	190

M Data missing

* Record incomplete

E Estimate

N.D. Not determined

** Record not computed

+ Less than 0.05 acre feet or less than 0.05 cfs, but greater than 0

RUNOFF – STREAM GAGING STATION PEAK FLOW

RIO HONDO BYPASS CHANNEL above Whittier Narrows STATION NO. F313B-R

Season	Daily CFS			Total Runoff (Acre-feet)	Peak Flow	
	Maximum	Minimum	Mean		Date	CFS
1986-87	177	0	67.3	48,539	Mar 18	233
1987-88	178	0	40.3	29,308	May 24	184
1988-89	192	0	80.4	58,223	Jan 19	201
1989-90	193	0	78.4	56,729	Jan 25	271
1990-91	174	0	27.8	20,195	Oct 01	189
1991-92	116	0	24.3	17,613	Feb 12	360
1992-93	165	0	29.3	21,195	Feb 18	355
1993-94	155	1.3	48.6	35,158	Jan 25	203
1994-95	136	0	15.5	11,242	Jan 10	359
1995-96	111	0	30.6	22,232	Feb 20	318
1996-97*	184	0	34.6	25,061	Jun 13	200
1997-98	200	0	31.6	22,865	May 05	214
1998-99	122	0	35.7	25,854	Jan 27	216
1999-00*	182	0	51.8	37,609	May 11	192
2000-01	159	0	23.7	17,130	Apr 07	178
2001-02	174	0	68	49,259	Dec 19	198
2002-03	227	0	70.2	50,862	Dec 16	288
2003-04	192	0	36	27,686	Feb 04	251
2004-05	192	0	26.1	18,900	Nov 21	240
2005-06	198	0	51.4	37,210	Mar 17	257
2006-07	221	0	107.7	44,840	Dec 02	233
2007-08	149	0	21.1	15,342	Jul 30	182
2008-09	94	0	6.6	4,750	Feb 05	136
2009-10	205	0	46.8	33,870	Feb 06	329
2010-11	201	0	39.4	28,420	Oct 30	237
2011-12	78	0	19.9	14,420	Feb 15	232
2012-13	94	0	16.7	12,120	Dec 29	222
2013-14	59.9	0	7.05	5,110	Oct 09	147
2014-15	8.5	0	0.76	549	Mar 10	13

M Data missing

* Record incomplete

E Estimate

N.D. Not determined

** Record not computed

+ Less than 0.05 acre feet or less than 0.05 cfs, but greater than 0

RUNOFF – STREAM GAGING STATION PEAK FLOW

**RUBIO DIVERSION CHANNEL below Gooseberry Inlet.
STATION NO. F338-R**

Season	Daily CFS			Total Runoff (Acre-feet)	Peak Flow	
	Maximum	Minimum	Mean		Date	CFS
1959-60	1	0	0	9	Jan 11	9
1960-61	1	0	0	6	Jan 26	5
1961-62	8	0	0.1	62	Feb 11	22
1962-63	3	0	0	20	Feb 10	32
1963-64	1	0	0	14	Jan 21	8
1964-65	1	0	0	30	Nov 09	21
1965-66	18	0	0.3	206	Dec 29	63
1966-67	13	0	0.2	127	Jan 22	43
1967-68	18	0	0.2	112	Nov 19	267
1968-69	254	0	4.2	3,050	Jan 25	880
1969-70	12	0	0.4	272	Feb 28	146
1970-71	36	0	0.6	413	Nov 29	266
1971-72	M	M	M	M		M
1972-73	58	+	1.5	1,098	Jan 18	114
1973-74	23	+	2.8	1,994	Nov 18	76
1974-75	11	+	0.9	627	Mar 06	85
1975-76	13	0	0.6	431	Feb 09	88
1976-77	5	0	0.5	384	May 09	47
1977-78	76	0	3	2,141	Mar 04	276
1978-79	5	0	0.7	494	Mar 28	71
1979-80	108	0.2	8.9	6,438	Feb 19	1,400
1980-81	13	0.4	3.6	2,598	May 02	115
1981-82	21	0	2.1	1,519	Apr 01	106
1982-83	150	0.2	3.1	2,391		296
1983-84	17	0	1	740	Oct 04	184
1984-85	10	0	0.5	332	Jan 18	31
1985-86	8	0	7.8	463		N.D.
1986-87	NO RECORD					
1987-88	9	0	0.7	526		N.D.
1988-89	6	0	0.9	631	Mar 25	6
1989-90	5	0	0.3	232		N.D.
1990-91	16	0	0.3	249	Mar 01	16
1991-92	45	0	2.2	1,592	Feb 10	191

M Data missing

* Record incomplete

E Estimate

N.D. Not determined

** Record not computed

+ Less than 0.05 acre feet or less than 0.05 cfs, but greater than 0

RUNOFF – STREAM GAGING STATION PEAK FLOW

**RUBIO DIVERSION CHANNEL below Gooseberry Inlet.
STATION NO. F338-R**

Season	Daily CFS			Total Runoff (Acre-feet)	Peak Flow	
	Maximum	Minimum	Mean		Date	CFS
1992-93	*	*	*	*		*
1993-94	*	*	*	*		*
1994-95	72	0	2.8	2,056	Feb 14	170
1995-96	41	0	1.6	1,139	Feb 20	131
1996-97	6	0	0.8	601	Sep 25	31
1997-98	10	0	1.5	1,050	Mar 02	106
1998-99	27	0	1.4	1,030	Mar 15	179
1999-00	6	0.2	0.5	360	Feb 16	94
2000-01	37	0	1.1	822	Jan 11	179
2001-02	3	0	0.4	203	Dec 20	89
2002-03	4	0	0.1	93	Mar 15	49
2003-04	6	0	0.1	80	Feb 26	55
2004-05	68	0	1.5	1,100	Jan 09	270
2005-06	34	0.2	2.4	1,730	Apr 14	194
2006-07	12	0	0.8	537	Apr 20	115
2007-08	20	0	1.3	939	Jan 04	226
2008-09	8	0	0.3	186	Nov 26	112
2009-10	11	0	0.45	328	Feb 06	191
2010-11	32	0	1.08	782	Dec 22	149
2011-12	5	0	0.13	95	Mar 17	106
2012-13	2	0	0.11	82	Oct 11	69
2013-14	3.12	0	0.046	33	Feb 28	24.3
2014-15	4.98	0	0.1	74	Dec 12	183

M Data missing

* Record incomplete

E Estimate

N.D. Not determined

** Record not computed

+ Less than 0.05 acre feet or less than 0.05 cfs, but greater than 0

RUNOFF – STREAM GAGING STATION PEAK FLOW

**RUBIO WASH at Glendon Way.
STATION NO. F82C-R**

Season	Daily CFS			Total Runoff (Acre-feet)	Peak Flow	
	Maximum	Minimum	Mean		Date	CFS
1930-31	107	0	1.5	1,110	Feb 03	1,690
1931-32	124	0	2.1	1,490	Nov 27	798
1932-33	234	0	1.5	1,110	Jan 16	1,510
1933-34	684	0	3.6	2,580	Dec 31	2,070
1934-35	134	0	2.4	1,770	Oct 17	1,680
1935-36	81	0	1.8	1,280	Feb 22	1,370
1936-37	186	0	3.9	2,800	Dec 27	1,180
1937-38	802	0	5.8	4,180	Mar 02	2,400E
1938-39	250	0	3.3	2,370	Jan 05	1,720
1939-40	122	0	2.4	1,270	Jan 07	1,000
1940-41	200	0	8.1	5,890	Mar 03	1,940
1941-42	130	0	2.1	1,530	Dec 10	1,200
1942-43	697	0	6.2	4,520	Mar 04	2,780
1943-44	393	0	4.4	3,190	Feb 22	1,930
1944-45	152	0	2.1	1,540	Nov 11	1,780
1945-46	244	0	2.5	1,840	Dec 22	1,630
1946-47	233	0	3.2	2,300	Nov 13	2,650
1947-48	91	0	1.5	1,080	Mar 24	2,090
1948-49	59	0	1.5	1,080	Oct 30	530
1949-50	161	0	2.3	1,690	Feb 06	1,060
1950-51	80	0	1.4	1,010	Jan 11	2,290
1951-52	335	0	7.3	5,300	Jan 16	3,020
1952-53	133	0	2	1,460	Nov 15	2,200
1953-54	288	+	3.4	2,490	Jan 19	2,310
1954-55	126	+	2.6	1,870	Jan 18	1,290
1955-56	639	0	4	2,880	Jan 26	1,970
1956-57	199	+	3.2	2,290	Feb 23	2,980
1957-58	286	0.1	7.7	5,610	Feb 19	2,740
1958-59	218	0.2	2.8	2,030	Jan 06	2,780
1959-60	135	0.2	2.5	1,820	Jan 11	985
1960-61	117	0.2	1.8	1,270	Nov 06	902
1961-62	281	0.1	5.7	4,120	Jan 20	1,200
1962-63	246	0.1	2.4	1,760	Feb 09	1,180

M Data missing

* Record incomplete

E Estimate

N.D. Not determined

** Record not computed

+ Less than 0.05 acre feet or less than 0.05 cfs, but greater than 0

RUNOFF – STREAM GAGING STATION PEAK FLOW

**RUBIO WASH at Glendon Way.
STATION NO. F82C-R**

Season	Daily CFS			Total Runoff (Acre-feet)	Peak Flow	
	Maximum	Minimum	Mean		Date	CFS
1963-64	136	0.2	2.6	1,870	Jan 21	1,570
1964-65	164	0.1	2.8	2,030	Apr 09	2,040
1965-66	466	0.1	6.4	4,650	Nov 24	2,300
1966-67	344	0.2	7.2	5,220	Dec 03	2,040
1967-68	343	0.2	4	2,930	Mar 08	2,460
1968-69	712	0.2	11.4	8,220	Jan 25	2,890
1969-70	**	**	**	**	Feb 28	2,540
1970-71	**	**	**	**	Nov 29	3,700
1971-72	**	**	**	**	Dec 24	1,240
1972-73	410	0	7.0*	5,041*	Feb 11	3,166
1973-74	460	0.2	5.5	3,950	Jan 07	1,985
1974-75	328	0.3	4.5	3,240	Dec 04	3,180
1975-76	373	0.2	4.1	2,920	Sep 10	2,070
1976-77	180	0.1	4.4	3,187	Oct 23	2,610
1977-78	531	0	12.9	9,340	Feb 10	*
1978-79	176	0	8.4	6,056	Feb 21	2,680
1979-80	781	0	11.8	8,372	Jan 29	4,594
1980-81	205	0	4.3	3,108	Mar 01	1,754
1981-82	186	0	4	2,890	Mar 17	1,650
1982-83	620	0.1	12.6	9,079	Mar 02	4,560
1983-84	165	0.1	2.8	1,976	Dec 25	1,680
1984-85	154	0.1	3.5	2,543	Dec 19	1,610
1985-86	212	0.1	6.1	4,445	Mar 08	2,090
1986-87	153	0.2	3.6	2,580	Oct 02	2,790
1987-88	246	0	4.3	3,113	Dec 04	3,620
1988-89	123	0.1	2.9	2,122	Dec 15	783
1989-90	341	0.3	4.5	3,249	Jan 16	1,560
1990-91	355	0	4.9	3,513	Mar 01	1,840
1991-92	287	0	5.7	4,115	Feb 12	2,540
1992-93	323	0	7.9	5,726	Jan 14	3,660
1993-94	105	0	2.3	1,640	Mar 24	1,970
1994-95	707	0	9.4	6,777	Mar 11	4,610
1995-96	656	0	7.5	5,464	Jan 31	5,010

M Data missing

* Record incomplete

E Estimate

N.D. Not determined

** Record not computed

+ Less than 0.05 acre feet or less than 0.05 cfs, but greater than 0

RUNOFF – STREAM GAGING STATION PEAK FLOW

**RUBIO WASH at Glendon Way.
STATION NO. F82C-R**

Season	Daily CFS			Total Runoff (Acre-feet)	Peak Flow	
	Maximum	Minimum	Mean		Date	CFS
1996-97	156	0	3.9	2,790	Jan 15	1,180
1997-98	438	0	9.1	6,590	Feb 06	4,030
1998-99	79	0	2.2	1,560	Nov 28	2,430
1999-00	218	0.1	5.6	4,030	Feb 21	2,710
2000-01	249	0.6	5.7	4,120	Jan 11	1,670
2001-02	186	0.4	3	2,187	Nov 24	3,553
2002-03	0	0	7.1	0	Mar 16	2,550
2003-04	336	0	3.9	2,811	Feb 26	2,970
2004-05	466	0.1	11.3	8,170	Oct 20	3,470
2005-06	270	0.1	4.7	3,430	Jan 02	2,663
2006-07	65	0.1	1.5	1,100	Feb 11	1,057
2007-08	407	0	5.1	3,717	Jan 04	3,859
2008-09	189	0	3.5	2,560	Feb 05	2,350
2009-10	267	0	5.4	3,900	Jan 18	3,330
2010-11	487	0.02	7.51	5,440	Dec 22	2,660
2011-12	172	0.19	3.03	2,200	Mar 17	2,030
2012-13	65	0.05	1.54	1,120	Oct 11	1,630
2013-14	284	0.05	1.51	1,090	Feb 28	1,440
2014-15	229	0	2.56	1,850	Dec 12	2,900

M Data missing

* Record incomplete

E Estimate

N.D. Not determined

** Record not computed

+ Less than 0.05 acre feet or less than 0.05 cfs, but greater than 0

RUNOFF – STREAM GAGING STATION PEAK FLOW

**SAN DIMAS CREEK below San Dimas Dam.
STATION NO. F303-R**

Season	Daily CFS			Total Runoff (Acre-feet)	Peak Flow	
	Maximum	Minimum	Mean		Date	CFS
1951-52	171	0	6.4	4,661	Mar 16	292
1952-53	6	0.1	1.5	1,116	Jul 06	7
1953-54	61	0	2.1	1,539	Jan 25	161
1954-55	6	0	0.8	563	Nov 16	175
1955-56	40	0	1.1	816	Jan 26	54
1956-57	5	0	0.6	435		5
1957-58	220	0	9.1	6,525	Apr 03	270
1958-59	19	0	1.8	1,261	Feb 18	20
1959-60	6	0	0.7	484	Aug 25	6
1960-61	17	0	0.4	292	Aug 01	20
1961-62	136	0	3.9	2,728	Dec 03	215
1962-63	83	0	1.5	1,104	Feb 09	404
1963-64	24	0	1	752		
1964-65	49	0.1	1.7	1,196	Apr 09	133
1965-66	242	0.1	8.8	6,332	Nov 23	500
1966-67	516	0	15.9	11,534	Dec 06	1,190
1967-68	N.D.					
1968-69	N.D.					
1969-70	N.D.					
1970-71	N.D.					
1971-72	N.D.					
1972-73	N.D.					
1973-74	N.D.					
1974-75	18	0.2	2.2	1,565	May 13	36
1975-76	9	0.1	1.3	926	Mar 22	14
1976-77	26	0	1.6	1,135	Apr 06	58
1977-78	703	0	0.8	18,359	Mar 04	938
1978-79	227	0.2	0.3	7,355	Mar 28	102
1979-80	894	0.1	0	0		
1980-81	26	0.3	4.4	3,217	Dec 01	27
1981-82	100	0.1	5.1	3,701	Mar 17	201
1982-83	5,840	0.4	24	17,376	Mar 01	883
1983-84	37	0.2	6	4,322	Feb 28	53

M Data missing

* Record incomplete

E Estimate

N.D. Not determined

** Record not computed

+ Less than 0.05 acre feet or less than 0.05 cfs, but greater than 0

RUNOFF – STREAM GAGING STATION PEAK FLOW

**SAN DIMAS CREEK below San Dimas Dam.
STATION NO. F303-R**

Season	Daily CFS			Total Runoff (Acre-feet)	Peak Flow	
	Maximum	Minimum	Mean		Date	CFS
1984-85	48	0.4	3.5	2,561	Jun 04	51
1985-86	56	0	3.3	2,415		
1986-87	9	0	0.9	616	Jan 04	23
1987-88	31	0.4	1.7	1,253		
1988-89	99	0.1	2	1,401	May 10	248
1989-90	50	0	0.5	365	Jun 08	198
1990-91	20	0.1	3.2	2,352	Oct 23	229
1991-92	136	0	5.3	3,831	Mar 24	150
1992-93	587	0.3	33.7	24,415	Jan 18	651
1993-94	22	0.3	3.3	2,389	Oct 27	130
1994-95	177	0.4	14	10,127	Mar 06	248
1995-96	73	0.5	5.7	4,111	Feb 22	78
1996-97	100	0.2	4.1	2,977	Apr 01	107
1997-98	271	0.4	16.3	11,837	Feb 24	452
1998-99	64	0	5.1	3,724	May 20	104
1999-00*	7	0	0.6	457	Jun 26	36
2000-01	41	0	2.2	1,570	May 15	293
2001-02	23	0	0.6	465	May 15	242
2002-03	152	0.1	3.3	2,371	Mar 16	771
2003-04	40	0.2	2.2	1,610	Dec 25	169
2004-05	1,110	0	32.9	23,700	Jan 11	1,410
2005-06	116	0.3	7.3	5,270	May 11	378
2006-07	12	0.3	2.2	1,558	Apr 19	183
2007-08	98	1.1	7.4	5,380	Nov 06	399
2008-09	60	1	5.7	4,130	Feb 19	67
2009-10	65	0	7.1	5,170	May 06	128
2010-11	251	0.81	11.9	8,630	Dec 22	357
2011-12	16	0.49	2.08	1,510	May 03	61
2012-13	16	0.04	0.91	658	Apr 09	792
2013-14	61.3	0	0.67	486	Jul 03	114
2014-15	26.8	0	0.48	350	May 18	62

M Data missing

* Record incomplete

E Estimate

N.D. Not determined

** Record not computed

+ Less than 0.05 acre feet or less than 0.05 cfs, but greater than 0

RUNOFF – STREAM GAGING STATION PEAK FLOW

**SAN DIMAS WASH below Puddingstone Diversion.
STATION NO. F218-R**

Season	Daily CFS			Total Runoff (Acre-feet)	Peak Flow	
	Maximum	Minimum	Mean		Date	CFS
1945-46	22	0	0.3	247	Apr 04	42
1946-47	10	0	0.7	484	Dec 27	10
1947-48	N.D.					
1948-49	N.D.					
1949-50	N.D.					
1950-51	N.D.					
1951-52	23	0	1.1	781	Mar 17	23
1952-53	N.D.					
1953-54	12	0	0.3	244	Feb 14	12
1954-55	N.D.					
1955-56	8	0	0.1	93	Jan 27	16
1956-57	N.D.					
1957-58	12	0	1.6	1,113	Mar 28	19
1958-59	5	0	0.1	49	Feb 12	7
1959-60	N.D.					
1960-61	14	0	0.1	72	Jul 21	15
1961-62	3	0	0.1	51	Apr 06	43
1962-63	10	0	0.4	286	Oct 25	16
1963-64	17	0	0.1	67	Apr 10	46
1964-65	19	0	0.5	334	May 11	35
1965-66	34	0	4.6	3,330	Jan 04	35
1966-67	12	0	2.9	2,098	Feb 13	44
1967-68	N.D.					
1968-69	N.D.					
1969-70	N.D.					
1970-71	N.D.					
1971-72	N.D.					
1972-73	N.D.					
1973-74	N.D.					
1974-75	19	0	1.1	786	Feb 18	30
1975-76	10	0	0.5	333	Mar 01	11
1976-77	17	0	0	0		
1977-78	32	0	9.1	6,621	Apr 28	40

M Data missing

* Record incomplete

E Estimate

N.D. Not determined

** Record not computed

+ Less than 0.05 acre feet or less than 0.05 cfs, but greater than 0

RUNOFF – STREAM GAGING STATION PEAK FLOW

**SAN DIMAS WASH below Puddingstone Diversion.
STATION NO. F218-R**

Season	Daily CFS			Total Runoff (Acre-feet)	Peak Flow	
	Maximum	Minimum	Mean		Date	CFS
1978-79	18	0	0.2	4,827	Dec 19	22
1979-80	27	0	6.9	4,966	Mar 29	28
1980-81	20	0	2.6	1,879	Feb 04	25
1981-82	27	0	3.4	2,446	Dec 09	40
1982-83	35	0	0.4	8,302	May 12	37
1983-84	22	0	0.1	2,884		
1984-85	21	0	1.8	1,282	Dec 27	22
1985-86	43	0	1.4	995	Mar 17	43
1986-87	7	0	0.5	703	Jan 05	16
1987-88	12	0	1	774	Jul 05	16
1988-89	14	0	1	691	Feb 04	16
1989-90	14	0	0.2	127	Jun 11	20
1990-91	19	0	2.8	2,012	Mar 06	21
1991-92	15	0	3.3	2,375	Apr 20	18
1992-93	19	0	4.5	3,225	Jan 11	27
1993-94	15	0	2.1	1,497	Feb 22	15
1994-95	21	0	7.7	5,554	Mar 30	23
1995-96	34	0	3.5	2,573	Feb 21	40
1996-97	35	0	2.7	1,980	Jan 28	36
1997-98	33	0	5.5	3,960	Feb 08	37
1998-99	25	0	1.8	1,290	Apr 22	30
1999-00	35	0	0.8	553	Jun 14	39
2000-01	27	0	1.1	819	Jun 03	29
2001-02	8	0	0.1	67	Jun 11	17
2002-03	19	0	0.8	554	Mar 16	38
2003-04	23	0	1.6	1,145	Dec 25	28
2004-05	29	0	6.7	4,830	Nov 02	35
2005-06	36	0	4.5	3,240	Apr 11	39
2006-07	8	0	3.5	378	Apr 10	11
2007-08	14	0	1.4	1,049	Feb 19	16
2008-09	16	0	1.2	898	Feb 10	22
2009-10	23	0	2.2	1,570	Jan 27	31
2010-11	18	0	2.89	2,100	Mar 30	19

M Data missing

* Record incomplete

E Estimate

N.D. Not determined

** Record not computed

+ Less than 0.05 acre feet or less than 0.05 cfs, but greater than 0

RUNOFF – STREAM GAGING STATION PEAK FLOW

**SAN DIMAS WASH below Puddingstone Diversion.
STATION NO. F218-R**

Season	Daily CFS			Total Runoff (Acre-feet)	Peak Flow	
	Maximum	Minimum	Mean		Date	CFS
2011-12	9	0	0.81	590	Mar 13	12
2012-13	7	0	0.14	101	Apr 29	7
2013-14	7.64	0	0.078	56	Jul 30	8.55
2014-15	5.72	0	0.21	149	May 21	5.81

M Data missing

* Record incomplete

E Estimate

N.D. Not determined

** Record not computed

+ Less than 0.05 acre feet or less than 0.05 cfs, but greater than 0

RUNOFF – STREAM GAGING STATION PEAK FLOW

**SAN GABRIEL RIVER - AZUSA CONDUIT 25 Ft. Weir Below S.G. Dam
STATION NO. F250-R**

Season	Daily CFS			Total Runoff (Acre-feet)	Peak Flow	
	Maximum	Minimum	Mean		Date	CFS
1934-35	116.0*	26.1*	81	36,610*		
1935-36	109	0	42.1	30,540		
1936-37	94	0	27.3	19,740		
1937-38	104	0	15.4	11,160		
1938-39	103	0	5.9	4,280		
1939-40	94	0	47.4	34,440		
1940-41	110	0	23.8	17,220		
1941-42	92	0	23.8	39,940		
1942-43	106	0	44.6	32,250		
1943-44	97	0	59.3	43,050		
1944-45	142	0	81.5	59,050		
1945-46	139	0	66.3	47,930		
1946-47	138	0	73.2	52,990		
1947-48	60	0	36.9	26,830		
1948-49	70	0	25	18,120		
1949-50	82	20	37.4	27,060		
1950-51	70	0	11.9	8,610		
1951-52	96	0	65.3	47,400		
1952-53	89	0	43.7	31,660		
1953-54	90	0	38.8	28,070		
1954-55	84	30	50.6	36,610		
1955-56	86	14.7	49	35,580		
1956-57	86	0	36.7	26,670		
1957-58	103	0	29.7	21,500		
1958-59	90	12.3	49.2	35,620		
1959-60	50	5.1	24.6	17,840		
1960-61	45	0	12.2	8,830		
1961-62	86	0	57.1	41,330		
1962-63	82	0.1	33.9	24,550		
1963-64	48	8	31	22,490		
1964-65	81	0.1	35.8	25,900		
1965-66	83	0	35.7	25,840		
1966-67	100	0	52.7	38,130		

M Data missing

* Record incomplete

E Estimate

N.D. Not determined

** Record not computed

+ Less than 0.05 acre feet or less than 0.05 cfs, but greater than 0

RUNOFF – STREAM GAGING STATION PEAK FLOW

SAN GABRIEL RIVER - AZUSA CONDUIT 25 Ft. Weir Below S.G. Dam STATION NO. F250-R

Season	Daily CFS			Total Runoff (Acre-feet)	Peak Flow	
	Maximum	Minimum	Mean		Date	CFS
1967-68	82	15	60.4	43,810		
1968-69	32	0	8.8	6,380		
1969-70	M	M	M	M		
1970-71	M	M	M	M		
1971-72	M	M	M	M		
1972-73	M	M	M	M		
1973-74	M	M	M	M		
1974-75	78	0	54.4	39,389	Oct 01	78
1975-76	77	0.9	45.9	33,347	Sep 30	145
1976-77	M	M	M	M		
1977-78	78	0	1.5	33,240		85
1978-79	105	49.1	72.2	52,249	Jul 02	106
1979-80	101	1.5	39.8	28,882	Jul 29	105
1980-81	99	0	53.7	38,894	Mar 16	105
1981-82	81	24.3	55.7	40,319		82
1982-83	85	34.1	2.3	50,283	Mar 04	98
1983-84	79	0	1.5	33,803	Feb 06	86
1984-85	*	*	*	*		N.D.
1985-86	81	0	56	40,696		
1986-87	45	0	29.2	21,124	Jan 08	47
1987-88	79	0.2	35.5	25,806	Sep 29	52
1988-89	85	0	46.6	33,739		
1989-90	35	0	21.9	15,863	Jul 16	35
1990-91	79	3	28.4	20,280	Sep 28	79
1991-92	83	0	52	37,764	Apr 29	101
1992-93	84	0	49.7	36,010	Feb 12	97
1993-94	82	0	58.5	42,340	Oct 25	89
1994-95	84	0	59.9	43,350	Feb 19	86
1995-96	77	0	55.4	40,190	Nov 06	90
1996-97	82	0	59.2	42,880	Jan 26	84
1997-98	83	0	51.3	37,140	Jul 04	109
1998-99	139	0	69.4	50,240	Nov 20	142
1999-00	73	0	38	27,610	Oct 01	76

M Data missing

* Record incomplete

E Estimate

N.D. Not determined

** Record not computed

+ Less than 0.05 acre feet or less than 0.05 cfs, but greater than 0

RUNOFF – STREAM GAGING STATION PEAK FLOW

**SAN GABRIEL RIVER - AZUSA CONDUIT 25 Ft. Weir Below S.G. Dam
STATION NO. F250-R**

Season	Daily CFS			Total Runoff (Acre-feet)	Peak Flow	
	Maximum	Minimum	Mean		Date	CFS
2000-01	87	0	46.5	33,640	Jul 06	90
2001-02	55	0.1	18.1	13,134	Nov 24	59
2002-03	86	0	17.6	19,988	Mar 27	94
2003-04	0	0	26	0	May 12	110
2004-05	83	0	30.7	22,200	Apr 28	130
2005-06	124	0	32.8	23,710	Apr 17	127
2006-07	45	0.2	24.4	13,160	Feb 17	71
2007-08	96	0	24.8	17,986	Sep 29	121
2008-09	135	0	33.9	24,510	Mar 04	139
2009-10	79	0	27.9	20,170	Jul 14	139
2010-11	64	0.22	54.6	39,530	Jan 25	70
2011-12	64	0	42	30,510	Feb 01	79
2012-13	30	0	10.2	7,360	Mar 03	30
2013-14	81.1	0	17.8	12,890	Jul 23	116
2014-15	34.9	0	8.73	6,320	Sep 09	41

M Data missing

* Record incomplete

E Estimate

N.D. Not determined

** Record not computed

+ Less than 0.05 acre feet or less than 0.05 cfs, but greater than 0

RUNOFF – STREAM GAGING STATION PEAK FLOW

**SAN GABRIEL RIVER - AZUSA CONDUIT 10 Ft. Weir Below S.G. Dam
STATION NO. F220B-R**

Season	Daily CFS			Total Runoff (Acre-feet)	Peak Flow	
	Maximum	Minimum	Mean		Date	CFS
1932-33	92	0	27.5	17,043		
1933-34	86	0	27.3	19,770		
1934-35	94	6.2	64.3	46,570		
1935-36	86	9.1	40.7	29,500		
1936-37	93	+	29	21,030		
1937-38	94	+	16.4	11,910		
1938-39	0	0	0	0		
1939-40	90	+	32.7	23,760		
1940-41	89	+	23.2	16,820		
1941-42	91	+	53	38,360		
1942-43	94	0.1	36.6	26,510		
1943-44	94	+	56.9	41,310		
1944-45	96	+	59.2	42,910		
1945-46	92	+	55	39,820		
1946-47	92	0.1	64.7	46,900		
1947-48	60	+	34.4	24,960		
1948-49	70	0.1	24	17,380		
1949-50	82	19	37.5	27,140		
1950-51	70	0	11.5	8,310		
1951-52	91	0	65.2	47,300		
1952-53	89	+	43.7	31,680		
1953-54	89	+	38.8	28,090		
1954-55	85	30	50.6	36,600		
1955-56	86	14.8	49	35,580		
1956-57	86	0	36.8	26,670		
1957-58	87	0	27.8	20,140		
1958-59	89	12.4	49.4	35,730		
1959-60	50	5.3	24.6	17,850		
1960-61	45	0	12.2	8,820		
1961-62	86	0	57.4	41,570		
1962-63	83	0	33	23,930		
1963-64	48	8	31	22,490		
1964-65D	81	0.1	35.8	25,900		

M Data missing

* Record incomplete

E Estimate

N.D. Not determined

** Record not computed

+ Less than 0.05 acre feet or less than 0.05 cfs, but greater than 0

RUNOFF – STREAM GAGING STATION PEAK FLOW

**SAN GABRIEL RIVER - AZUSA CONDUIT 10 Ft. Weir Below S.G. Dam
STATION NO. F220B-R**

Season	Daily CFS			Total Runoff (Acre-feet)	Peak Flow	
	Maximum	Minimum	Mean		Date	CFS
1965-66D	83	0	35.7	25,840		
1966-67B	84	0	41.8	30,250		
1967-68	82	+	50.3	36,480		
1968-69	54	0	1.1	777		
1969-70	61	0	5.4	3,920		
1970-71	75	0	42.4	30,710		
1971-72	70	0	25.6	18,590		
1972-73	76	0	19	13,656		
1973-74	82	0	62.2	44,943		
1974-75	78	0	54.4	39,381		
1975-76	77	0.9	46.1	33,591		
1976-77	71	1.1	40.7	29,491		
1977-78	N.D.					
1978-79	N.D.					
1979-80	N.D.					
1980-81	N.D.					
1981-82	N.D.					
1982-83*	*	*	*	*		
1983-84	N.D.					
1984-85	N.D.					
1985-86	N.D.					
1986-87	N.D.					
1987-88	N.D.					
1988-89	845	0	47	34,049	Dec 06	86
1989-90	N.D.					
1990-91	N.D.					
1991-92	N.D.					
1992-93*	84*	12.9*	63.1*	14650*		
1993-94	N.D.					
1994-95	N.D.					
1995-96	N.D.					
1996-97	N.D.					
1997-98	79	0	46.8	33,850	Jul 26	91

M Data missing

* Record incomplete

E Estimate

N.D. Not determined

** Record not computed

+ Less than 0.05 acre feet or less than 0.05 cfs, but greater than 0

RUNOFF – STREAM GAGING STATION PEAK FLOW

**SAN GABRIEL RIVER - AZUSA CONDUIT 10 Ft. Weir Below S.G. Dam
STATION NO. F220B-R**

Season	Daily CFS			Total Runoff (Acre-feet)	Peak Flow	
	Maximum	Minimum	Mean		Date	CFS
1998-99	74	0	64.2	46,450	Nov 27	85
1999-00	72	0	38	27,600	Jul 03	77
2000-01	73	0	44.5	32,200	Jul 14	76
2001-02	54	0.1	18.1	13,131	Nov 19	55
2002-03	18	0	0.4	321	Apr 08	29
2003-04	44	0	15	10,545	Nov 25	65
2004-05	57	0	11.4	8,250	Apr 28	85
2005-06	60	0	13.3	9,560	Apr 18	80
2006-07	42	0.1	25.6	12,076	Nov 06	42
2007-08	57	0	12.8	9,312	Jul 03	85
2008-09	50	0	31.1	22,510	Apr 07	65
2009-10	49	0	2.8	2,000	Oct 12	50
2010-11	62	0	42.9	31,040	Jan 25	77
2011-12	60	0	42.8	31,050	Oct 16	61
2012-13	27	0	5.8	4,200	Nov 29	27
2013-14	16.3	0	3.03	2,190	Nov 25	38
2014-15	50.5	0	8.82	6,380	Apr 06	55

M Data missing

* Record incomplete

E Estimate

N.D. Not determined

** Record not computed

+ Less than 0.05 acre feet or less than 0.05 cfs, but greater than 0

RUNOFF – STREAM GAGING STATION PEAK FLOW

**SAN GABRIEL RIVER above Firestone Avenue.
STATION NO. F262C-R**

Season	Daily CFS			Total Runoff (Acre-feet)	Peak Flow	
	Maximum	Minimum	Mean		Date	CFS
1934-35	718	0	6.5	4,700	Oct 17	5,850
1935-36	414	0	2.4	1,750	Feb 12	3,400
1936-37	NO RECORD					
1937-38	NO RECORD					
1938-39	325	0		2,540*	Sep 25	1,380
1939-40	271	0	2.6	1,900	Jan 08	1,150
1940-41	2,390	0	105	75,780	Mar 04	5,630
1941-42	117	0	18.7	13,570	Dec 10	413
1942-43	9,190	0	257	186,400	Jan 23	14,000
1943-44	4,860	0	110	79,930	Feb 22	16,000
1944-45	806	0	36.1	26,110	Nov 12	4,020
1945-46	1,500	0	22.8	16,480	Dec 23	4,370
1946-47	2,880	0	38.2	27,650	Dec 31	3,640
1947-48	0	0	0	0		0
1948-49	0	0	0	0		0
1949-50	0	0	0	0		0
1950-51	0	0	0	0		0
1951-52	3,070	0	33.4	24,250	Jan 16	8,040
1952-53	181	0	1.4	983	Dec 02	1,270
1953-54	688	0	5.2	3,790	Feb 13	4,060
1954-55	317	0	1.4	1,000	Jan 18	1,850
1955-56	4,580	0	14.3	10,360	Jan 26	12,800E
1956-57	490	0	1.9	1,390	Jan 13	2,040
1957-58	1,720	0	31.9	23,960	Apr 07	6,300
1958-59	826	0	4.3	3,130	Jan 06	4,060
1959-60	377	0	2.7	1,990	Jan 12	2,210
1960-61	316	0	0.9	678	Jan 26	2,940
1961-62	2,170	0	23.7	17,340	Feb 11	6,470
1962-63	1,190	0	7.1	5,160	Mar 16	4,270
1963-64	707	0	4.8	3,460	Nov 20	4,330
1964-65	1,210	0	12.4	9,010	Apr 09	4,900
1965-66	697	0	7.8	5,620	Jan 30	2,080
1966-67	1,900	0	32.2	23,300	Jan 23	4,320

M Data missing

* Record incomplete

E Estimate

N.D. Not determined

** Record not computed

+ Less than 0.05 acre feet or less than 0.05 cfs, but greater than 0

RUNOFF – STREAM GAGING STATION PEAK FLOW

**SAN GABRIEL RIVER above Firestone Avenue.
STATION NO. F262C-R**

Season	Daily CFS			Total Runoff (Acre-feet)	Peak Flow	
	Maximum	Minimum	Mean		Date	CFS
1967-68	NO RECORD					
1968-69	8,430	0	273	197,600	Jan 25	10,900
1969-70	1,650	0	16.5	11,950	Mar 04	4,510
1970-71	2,160	0	15.5	11,220	Nov 29	4,410
1971-72	1,450	0	10.2	7,400	Dec 24	7,510
1972-73	2,540	0	28.6	20,700	Feb 11	5,680
1973-74	3,650	0	26.8	19,420	Jan 07	5,870
1974-75	1,390	0	8.4	6,110	Dec 04	6,010
1975-76	690	0	5.9	4,160	Sep 10	2,800
1976-77	486	0	4.4	3,171	Jan 03	3,320
1977-78	5,440	0	224	162,158	Feb 12	8,220
1978-79	*	*	*	*		*
1979-80	9,290	0	222.3	156,500	Feb 17	10,900
1980-81	219	0	1.1	773	Mar 02	414
1981-82	186	0	1	723	Mar 17	755
1982-83	4,920	0	95.2	68,938	Mar 01	10,400
1983-84	131	0	1.8	1,341	Nov 25	179
1984-85	215	0	2.4	1,771	Dec 19	283
1985-86	528	0	6.4	4,597	Sep 25	4,510
1986-87	585	0	2.7	1,936	Jan 04	3,350
1987-88	76	0	0.6	466	Apr 21	327
1988-89	148	0	1.1	825	Dec 25	1,174
1989-90	32	0	0.1	65	Feb 17	353
1990-91	169	0	1	694	Mar 27	605
1991-92	673	0	5.3	3,840	Feb 12	2,340
1992-93	6,990	0	276	199,500	Jan 18	7,600
1993-94	0	0	0	0		-
1994-95	1,520	0	35.6	25,760	Jan 10	5,120
1995-96	871	0	3.8	2,727	Feb 21	2,360
1996-97	291	0	5.1	3,710	Dec 11	1,240
1997-98	5,750	0	168	121,400	Mar 26	8,070
1998-99	19	0	0.2	116	Nov 08	78
1999-00	159	0	1.1	788	Mar 08	3,130

M Data missing

* Record incomplete

E Estimate

N.D. Not determined

** Record not computed

+ Less than 0.05 acre feet or less than 0.05 cfs, but greater than 0

RUNOFF – STREAM GAGING STATION PEAK FLOW

**SAN GABRIEL RIVER above Firestone Avenue.
STATION NO. F262C-R**

Season	Daily CFS			Total Runoff (Acre-feet)	Peak Flow	
	Maximum	Minimum	Mean		Date	CFS
2000-01	708	0	4.8	3,480	Jan 11	2,180
2001-02	243	0	1	555	Nov 24	1,756
2002-03	312	0	1.6	1,143	Feb 12	1,430
2003-04	0	0	0.5	0	Feb 26	856
2004-05	5,940	0	199	144,000	Feb 21	7,930
2005-06	969	0	7.2	5,180	Apr 05	2,819
2006-07	101	0.5	34.2	203	Dec 10	488
2007-08	220	0	1.4	1,049	Jan 27	1,251
2008-09	19	0	0.2	116	Feb 05	115
2009-10	411	0	3.2	2,320	Feb 06	1,380
2010-11	383	0	3.24	2,340	Dec 22	1,670
2011-12	39	0	0.21	150	Oct 05	249
2012-13	ND	ND	ND	ND	ND	ND
2013-14	ND	ND	ND	ND	ND	ND
2014-15	ND	ND	ND	ND	ND	ND

M Data missing

* Record incomplete

E Estimate

N.D. Not determined

** Record not computed

+ Less than 0.05 acre feet or less than 0.05 cfs, but greater than 0

RUNOFF – STREAM GAGING STATION PEAK FLOW

**SAN GABRIEL RIVER above Spring Street.
STATION NO. F42B-R**

Season	Daily CFS			Total Runoff (Acre-feet)	Peak Flow	
	Maximum	Minimum	Mean		Date	CFS
1927-28	0	0	0	0		0
1928-29	0	0	0	0		0
1929-30	0	0	0	0		0
1930-31	0	0	0	0		0
1931-32	1,270	0	9	6,560	Feb 09	4,490
1932-33	170	0	1.1	809	Jan 20	2,250
1933-34	4,860	0	17.1	12,370	Jan 01	15,000
1934-35	463	0	3.3	2,380	Oct 17	3,390
1935-36	220	0	1.6	1,190	Feb 12	1,910
1936-37	1,850	0	18.7	13,510	Feb 14	4,560
1937-38	14,500	0	122	88,020	Mar 02	27,000E
1938-39	265	0	1.5	1,080	Dec 19	956
1939-40	192.0E	0	2	1,460	Feb 03	1,400
1940-41	1,710	0	91	65,890	Mar 13	4,830
1941-42	148	0	15	10,830	Dec 11	277
1942-43	9,570	0	280	175,100	Jan 23	14,600
1943-44	5,570	0	99.4	72,200	Feb 22	15,000
1944-45	742	0	30.8	22,280	Feb 02	1,910
1945-46	1,460	0	17.4	12,590	Dec 23	3,300
1946-47	2,520	0	33.3	24,100	Jan 01	2,740
1947-48	0	0	0	0		0
1948-49	0	0	0	0		0
1949-50	0	0	0	0		0
1950-51	0	0	0	0		0
1951-52	STATION	OUT		21,100E		0
1952-53	101	0	0.3	220	Dec 02	301
1953-54	445	0	2.9	2,060	Feb 13	3,520
1954-55	240	0	1.1	820	Jan 18	1,640
1955-56	4,300	0	12.9	9,390	Jan 26	12,500
1956-57	393	0	1.2	896	Jan 13	1,760
1957-58	1,510	0	31.6	22,890	Apr 07	5,220
1958-59	615	0	3.2	2,340	Jan 06	2,940

M Data missing

* Record incomplete

E Estimate

N.D. Not determined

** Record not computed

+ Less than 0.05 acre feet or less than 0.05 cfs, but greater than 0

RUNOFF – STREAM GAGING STATION PEAK FLOW

**SAN GABRIEL RIVER above Spring Street.
STATION NO. F42B-R**

Season	Daily CFS			Total Runoff (Acre-feet)	Peak Flow	
	Maximum	Minimum	Mean		Date	CFS
1959-60	355	0	2.6	1,860	Jan 12	2,180
1960-61	204	0	0.6	448	Jan 26	1,780
1961-62	2,940	0	32	23,070	Feb 11	7,350
1962-63	1,530	0	7.3	5,290	Mar 17	4,120
1963-64	751	0	4.4	3,160	Jan 22	2,570
1964-65	1,070	0	12.1	8,770	Apr 09	4,540
1965-66	630	0	10.2	7,400	Feb 06	1,950
1966-67	1,190	0	37.1	26,850	Jan 23	4,760
1967-68	847	+	9.2	6,720	Nov 21	3,280
1968-69	9,350	+	286	207,300	Jan 25	11,700
1969-70	1,760	+	24.2	17,520	Mar 05	5,550
1970-71	2,700	+	27.1	19,610	Dec 19	5,550
1971-72	1,980	0.1	82.2	39,900	Dec 24	8,580
1972-73	2,710	10.6	70.6	51,100	Jan 16	5,680
1973-74	3,730	10.6	63.9	46,220	Jan 04	6,090
1974-75	2,190	6.1	48.1	34,850	Dec 04	7,190
1975-76	660	12.6	50.5	36,640	Sep 10	3,890
1976-77	816	20	54.7	39,600	Jan 03	4,460
1977-78	*	*	*	*		*
1978-79	*	*	*	*	Jan 31	*
1979-80	8,310	19.3	252.7	179,251	Feb 14	11,000
1980-81	*	*	*	*		*
1981-82	433	31.4	74.5	53,942	Mar 14	1,260
1982-83	5,900	43.4	221	159,961	Mar 01	13,400
1983-84	483	32.9	109	78,947	Nov 01	4,470
1984-85	488	44.2	3.8	84,238	Feb 09	1,480
1985-86	*	*	*	*	Feb 15	3,930
1986-87	1,110	32.9	113.3	82,029	Jan 04	4,990
1987-88	727	26	108.4	78,667	Dec 04	2,220
1988-89	406	33.3	91	65,899	Dec 25	2,080
1989-90	880	4.3	81	58,661	Feb 17	1,610
1990-91	813	25.7	78.2	56,581	Mar 01	1,610

M Data missing

* Record incomplete

E Estimate

N.D. Not determined

** Record not computed

+ Less than 0.05 acre feet or less than 0.05 cfs, but greater than 0

RUNOFF – STREAM GAGING STATION PEAK FLOW

**SAN GABRIEL RIVER above Spring Street.
STATION NO. F42B-R**

Season	Daily CFS			Total Runoff (Acre-feet)	Peak Flow	
	Maximum	Minimum	Mean		Date	CFS
1991-92	2,000	28.4	107	77,647	Feb 12	6,330
1992-93	6,480	19.8	389	269,000	Feb 19	10,100
1993-94	*	*	*	*		*
1994-95	3,230	33.3	173	125,400	Mar 11	10,200
1995-96	1,120	25.8	112	81,050	Feb 20	4,330
1996-97	738	51	143	97,910	Dec 11	2,410
1997-98	5,550	57	276	199,900	Feb 07	12,500
1998-99	290	52	136	98,720	Apr 11	1,120
1999-00	414	59	126	91,220	Mar 08	2,240
2000-01	2,010	27	159	115,200	Jan 11	8,480
2001-02	846	1.6	112	80,818	Nov 24	4,065
2002-03	1,626	33.4	96.1	132,238	Feb 12	5,190
2003-04	1,595	44.6	157	114,094	Feb 26	5,780
2004-05	6,230	21	323	234,000	Feb 20	10,100
2005-06	1,170	61	132	95,700	Sep 11	10,772
2006-07	520	66.7	121	87,617	Feb 13	4,611
2007-08	611	0	132.3	96,058	Sep 10	3,156
2008-09	648	46.3	127	91,970	Dec 10	14,700
2009-10	1,380	35	91.2	66,020	Feb 06	5,910
2010-11	1,910	1.43	95.6	69,220	Dec 20	11,200
2011-12	964	17.5	98.1	71,190	Apr 09	2,290
2012-13	352	20.3	108	78,320	Jun 17	1,640
2013-14	479	28.8	75.6	54,710	Feb 27	1,500
2014-15	382	0.31	72.8	52,680	May 14	1,340

M Data missing

* Record incomplete

E Estimate

N.D. Not determined

** Record not computed

+ Less than 0.05 acre feet or less than 0.05 cfs, but greater than 0

RUNOFF – STREAM GAGING STATION PEAK FLOW

**SAN GABRIEL RIVER below San Gabriel River Pkwy.
STATION NO. F263C-R**

Season	Daily CFS			Total Runoff (Acre-feet)	Peak Flow	
	Maximum	Minimum	Mean		Date	CFS
1928-29	93	0	3.9	2,850	Mar 10	397
1929-30	152	0	4.8	3,490	Jan 11	726
1930-31	106	0	3.4	2,490	Feb 04	404
1931-32	1,620	0	18	13,060	Feb 09	3,830
1932-33	286	0	4.2	3,040	Jan 29	1,450
1933-34	5,580	0	23.4	16,950	Jan 01	22,000
1934-35	746	0	16.8	12,190	Oct 17	5,400
1935-36	355	0	6.3	4,590	Feb 12	3,400
1936-37	2,440	0	47.3	34,240*	Feb 14	6,970
1937-38	11,400	0	131	94,810	Mar 02	22,700E
1938-39	672	0	34.1	24,620	Sep 25	2,110
1939-40	544	0	27.8	20,180	Feb 01	2,110
1940-41	2,700	0	139	100,900	Mar 04	5,830
1941-42	149	0	39.5	28,630	Dec 10	412
1942-43	10,500	0	289	209,600	Jan 23	14,810
1943-44	5,350	0	144	104,200	Feb 22	14,100
1944-45	744	0	58.7	42,520	Nov 12	4,210
1945-46	1,660	0	47.5	34,370	Dec 23	4,660
1946-47	2,810	0	62.7	45,420	Dec 30	3,240
1947-48	48	0	11.8	8,590	Feb 06	84
1948-49	77	0	8.9	6,470	Jan 20	144
1949-50	272	0	5.7	4,130	Feb 06	845
1950-51	16	0	0.8	558	Jan 30	27
1951-52	2,860	0	70.2	50,900	Jan 16	14,000
1952-53	327	0	19.2	13,880	Dec 02	1,450
1953-54	901	0	15.2	10,990	Feb 13	5,450
1954-55	323	0	12.8	9,250	Jan 18	1,590
1955-56	4,030	0	33.1	24,050	Jan 26	12,400
1956-57	558	0	24.9	18,000	Mar 01	3,600
1957-58	2,210	0	114	82,190	Apr 07	6,890
1958-59	777	0	16.9	33,960	Jan 06	3,870
1959-60	449	0	49.7	36,100	Jan 12	2,390

M Data missing

* Record incomplete

E Estimate

N.D. Not determined

** Record not computed

+ Less than 0.05 acre feet or less than 0.05 cfs, but greater than 0

RUNOFF – STREAM GAGING STATION PEAK FLOW

**SAN GABRIEL RIVER below San Gabriel River Pkwy.
STATION NO. F263C-R**

Season	Daily CFS			Total Runoff (Acre-feet)	Peak Flow	
	Maximum	Minimum	Mean		Date	CFS
1960-61	421	0	65.9	47,700	Jan 26	1,330
1961-62	2,840	0	142	103,100	Feb 11	8,810
1962-63	1,080	0	58.6	42,430	Mar 17	4,320
1963-64	881	0	63	45,700	Jan 22	3,380
1964-65	1,410	0	107	77,270	Apr 09	5,590
1965-66	916	0	76.4	55,320	Feb 06	2,670
1966-67	2,270	0.3	86.7	62,800	Jan 23	5,680
1967-68	222	3.2	36.2	26,240	Nov 19	330
1968-69	10,210	15	379	274,300	Jan 26	11,740
1969-70	1,880	13	109	79,110	Mar 04	5,530
1970-71	2,170	2.6	75.4	54,590	Dec 21	4,610
1971-72	1,900	0	45.1	32,740	Dec 24	6,970
1972-73	2,540	0	92.6	67,020	Feb 11	5,620
1973-74	3,640	4	83.6	60,500	Jan 04	6,170
1974-75	2,050	1	52.7	38,190	Dec 04	7,520
1975-76	1,500	0	44.4	32,000		N.D.
1976-77	739	0	23	16,670	Jan 03	4,080
1977-78	6,630	0	353.4	256,222	Mar 01	7,650
1978-79	338	2.3	51	36,943	Jan 15	2,052
1979-80	9,140	6	283.9	201,315	Feb 19	10,600
1980-81	336	3.8	33	23,902	Mar 01	577
1981-82	290	0	32	23,162	Mar 14	523
1982-83	4,740	7.7	163.1	118,084	Mar 01	8,650
1983-84	152	3.8	30.6	22,254	Oct 01	414
1984-85	387	3.1	31.1	22,522	Dec 18	750
1985-86	598	0.5	59.4	31,244	Sep 25	3,340
1986-87	1,060	0	30.3	21,994	Jan 04	5,140
1987-88	559	0	32.7	23,684	Apr 20	1,270
1988-89	570	0	28.9	20,899	Dec 24	3,020
1989-90	612	0	39.6	28,677	Feb 17	947
1990-91	787	0	34.7	24,904	Feb 28	1,140
1991-92	1,320	0	42	30,460	Feb 12	3,390

M Data missing

* Record incomplete

E Estimate

N.D. Not determined

** Record not computed

+ Less than 0.05 acre feet or less than 0.05 cfs, but greater than 0

RUNOFF – STREAM GAGING STATION PEAK FLOW

**SAN GABRIEL RIVER below San Gabriel River Pkwy.
STATION NO. F263C-R**

Season	Daily CFS			Total Runoff (Acre-feet)	Peak Flow	
	Maximum	Minimum	Mean		Date	CFS
1992-93	6,460	0	377	273,200	Jan 18	7,430
1993-94	387	0.2	35.9	26,000	Jan 25	1,520
1994-95	2,470	0	146	105,900	Mar 11	5,070
1995-96	794	1.6	47.8	34,720	Jan 31	1,620
1996-97	1,210	0.7	73.9	53,530	Dec 09	2,040
1997-98	5,450	2.4	233	168,600	Feb 23	7,060
1998-99	350	0	35.5	25,720	Feb 05	621
1999-00	607	0.1	58.6	42,560	Jun 06	2,550
2000-01	1,240	0	68.3	49,420	Feb 25	4,620
2001-02	766	0	47.3	34,260	Nov 24	4,017
2002-03	1,576	0	45.2	32,731	Feb 12	5,360
2003-04	1,259	0	34	24,869	Feb 26	4,080
2004-05	5,800	0	306	222,000	Feb 21	7,090
2005-06	1,280	3.7	71.7	51,940	Jan 02	5,868
2006-07	374	0	57.7	39,685	Feb 21	980
2007-08	510	0	50.5	36,623	Dec 07	2,288
2008-09	767	0	28.8	20,860	Dec 15	1,840
2009-10	528	0	36.8	26,530	Jan 20	1,450
2010-11	1,160	0	80.2	58,060	Dec 22	3,140
2011-12	455	0.22	26.8	19,460	Oct 05	1,290
2012-13	365	0	8.36	6,030	Jan 24	1,750
2013-14	289	0	3.42	2,470	Feb 27	657
2014-15	532	0	45.7	33,080	Dec 02	1,670

M Data missing

* Record incomplete

E Estimate

N.D. Not determined

** Record not computed

+ Less than 0.05 acre feet or less than 0.05 cfs, but greater than 0

RUNOFF – STREAM GAGING STATION PEAK FLOW

**SAN GABRIEL RIVER at Foothill Blvd.
STATION NO. F190-R**

Season	Daily CFS			Total Runoff (Acre-feet)	Peak Flow	
	Maximum	Minimum	Mean		Date	CFS
1931-32	N.D.	0	N.D.	76,220*		N.D.
1932-33	2,530	0	15.7	11,400	Jan 19	10,000
1933-34	3,150	0	20.3	14,690	Jan 01	5,550
1934-35	448	0	81.7	59,220	Apr 08	1,080
1935-36	169	0	21.1	15,300	Feb 02	572
1936-37	1,610	0	162	117,400	Feb 19	2,050
1937-38	22,200	0	387.2	280,300*	Mar 02	62,000E
1938-39	220	0	15	10,850	Jan 05	267
1939-40	388	0	13.7	9,980	Jun 25	400
1940-41	4,090	0	304	220,100	Mar 04	5,280
1941-42	312	0	5.5	3,990	Apr 20	345
1942-43	10,400E	0	318	230,200	Feb 23	11,400
1943-44	2,750	0	163	118,300	Feb 22	4,840
1944-45	844	0	22.9	16,620	Feb 02	1,080
1945-46	1,190	0	58.1	42,060	Dec 23	1,670
1946-47	3,000	0	65.6	47,520	Dec 28	3,200
1947-48	1,010	0	14.3	10,370	Jun 02	1,120
1948-49	0	0	0	0		0
1949-50	20	0	0.1	67	Dec 18	192
1950-51	0	0	0	0		0
1951-52	3,860	0	98.1	71,210	Jan 18	4,670
1952-53	1,030	0	56.9	41,180	Oct 28	1,080
1953-54	848	0	30.3	21,920	Apr 16	2,160
1954-55	4	0	+	38	Jan 18	12
1955-56	215	0	2	1,430	Jan 26	800
1956-57	573	0	7.4	5,320	Apr 17	585
1957-58	2,270	0	229	165,600	Apr 05	2,520
1958-59	380	0	18.8	13,590	Jan 06	3,390
1959-60	13	0	0.7	499	Apr 27	90
1960-61	26	0	0.2	147	Jan 26	48
1961-62	1,750	0	103	74,270	Feb 12	2,260
1962-63	47	0	0.3	237	Feb 09	301
1963-64	13	0	0.1	66	Jan 22	56

M Data missing

* Record incomplete

E Estimate

N.D. Not determined

** Record not computed

+ Less than 0.05 acre feet or less than 0.05 cfs, but greater than 0

RUNOFF – STREAM GAGING STATION PEAK FLOW

**SAN GABRIEL RIVER at Foothill Blvd.
STATION NO. F190-R**

Season	Daily CFS			Total Runoff (Acre-feet)	Peak Flow	
	Maximum	Minimum	Mean		Date	CFS
1964-65	293	0	11	7,940	Sep 06	881
1965-66	8,680	0	240	173,700	Nov 23	9,420
1966-67	2,080	0	249	180,000	Dec 06	9,830
1967-68	232	0	33	23,940	Nov 25	326
1968-69	22,700	0	794	575,300	Jan 26	N.D.
1969-70	378	0	32.9	23,810	Dec 21	411
1970-71	1,300	0	44	31,850	Mar 01	1,400
1971-72	254	0	13.3	9,660	Dec 08	254
1972-73	803	0	129	93,260	Feb 11	1,010
1973-74	374	0	56.2	40,640	Jan 07	670
1974-75	256	0	37.3	27,040		256
1975-76	179	0	27.3	19,833	Mar 01	10,002
1976-77	226	0	24.6	17,770	Oct 14	248
1977-78	*	*	664.2	480,390	Mar 04	24,300
1978-79	525	0	153	110,800	Mar 27	720
1979-80	8,751	0	440	313,199		N.D.
1980-81	362	0	23.8	17,247	Jan 29	477
1981-82	573	0.1	79.8	57,237	Mar 14	720
1982-83	12,810	0	16.1	356,249	Mar 02	12,810
1983-84	432	1.8	50.9	36,846		N.D.
1984-85	396	0	16.7	12,084		N.D.
1985-86	805	0	117	84,632	Mar 03	805
1986-87	112	0	31.2	22,594	Mar 06	130
1987-88	544	0	62.3	444,868	Jun 08	805
1988-89	464	0	49.6	35,849	Feb 04	1,130
1989-90	145	0	26.7	19,337	Apr 17	155
1990-91	567	0	74.1	52,908	Jul 27	578
1991-92	1,580	0	200	144,865	Feb 15	4,000
1992-93	8,600	0	598	432,600	Feb 16	11,300
1993-94	393	0	53.4	38,660	Feb 17	1,750
1994-95	2,180	0	278	201,100	Mar 06	5,020
1995-96	531	0	91.7	66,560	Oct 06	1,130
1996-97	563	0	62.3	45,100	Dec 22	522

M Data missing

* Record incomplete

E Estimate

N.D. Not determined

** Record not computed

+ Less than 0.05 acre feet or less than 0.05 cfs, but greater than 0

RUNOFF – STREAM GAGING STATION PEAK FLOW

**SAN GABRIEL RIVER at Foothill Blvd.
STATION NO. F190-R**

Season	Daily CFS			Total Runoff (Acre-feet)	Peak Flow	
	Maximum	Minimum	Mean		Date	CFS
1997-98	7,660	0	319	230,900	Feb 24	11,900
1998-99	216	0	28.2	20,420	Jul 15	326
1999-00	272	0	40.9	29,690		N.D.
2000-01	377	0	45.9	33,220	Dec 13	730
2001-02	350	0	22	15,916	Oct 31	460
2002-03	543	0	51.3	37,111	Mar 16	669
2003-04	0	0	56	0	Feb 26	806
2004-05	15,300	0	674	488,000	Jan 11	18,800
2005-06	613	0	148	107,000	May 11	662
2006-07	71	0.2	25.8	2,963	Nov 15	142
2007-08	550	0	35.7	25,899	Jul 29	1,242
2008-09	339	0	10.6	7,640	Jul 27	731
2009-10	466	0	99.4	71,950	Apr 14	493
2010-11	1,040	1.61	283	205,000	Feb 26	1,650
2011-12	432	0	32.1	23,280	Nov 29	1,720
2012-13	127	0	7.87	5,700	Nov 06	136
2013-14	231	0	15.9	11,540	Nov 25	238
2014-15	7	0	0.29	210	Dec 17	13

M Data missing

* Record incomplete

E Estimate

N.D. Not determined

** Record not computed

+ Less than 0.05 acre feet or less than 0.05 cfs, but greater than 0

RUNOFF – STREAM GAGING STATION PEAK FLOW

SAN GABRIEL RIVER below Santa Fe Dam.
STATION NO. E281-R

Season	Daily CFS			Total Runoff (Acre-feet)	Peak Flow	
	Maximum	Minimum	Mean		Date	CFS
1942-43	6,700	0	242	175,100	Jan 23	8,000
1943-44	2,550	0	133	96,890	Feb 22	3,480
1944-45	783	0	14	10,140	Feb 02	960
1945-46	1,140	0	45	32,560	Dec 23	1,600
1946-47	2,550	0	53.3	38,600	Dec 31	2,580
1947-48	809	0	11.2	8,120	Jun 04	822
1948-49	0	0	0	0		
1949-50	0	0	0	0		
1950-51	0	0	0	0		
1951-52	838	0	45.2	32,800	Jan 17	861
1952-53	488	0	23.5	16,990	Oct 30	598
1953-54	0	0	0	0		
1954-55	0	0	0	0		
1955-56	0	0	0	0		
1956-57	0	0	0	0		
1957-58	944	0	126	91,530	Apr 05	1,210
1958-59	342	0	12.4	9,000	Feb 24	606
1959-60	3	0	0.2	15	Feb 02	7
1960-61	0	0	0	0		
1961-62	437	0	46.2	33,450	Feb 13	728
1962-63	0	0	0	0		
1963-64	24	0.1	1	754		
1964-65	0	0	0	0		
1965-66	6,000	0	133	96,200	Nov 23	11,000
1966-67	597	0	62.1	44,930	Mar 23	614
1967-68	3	0	+	6	Nov 29	30
1968-69	26,000	0	540	391,200	Jan 26	30,900
1969-70	263	0	13.3	9,600	Mar 04	458
1970-71	116	0	6.5	4,722	Dec 17	116
1971-72	12	0	0.2	182	Dec 12	25
1972-73	310	0	32.6	23,331	Mar 22	340
1973-74	85	0	1.4	1,007	Apr 15	146
1974-75	No Data	from 1975	to 1998			

M Data missing

* Record incomplete

E Estimate

N.D. Not determined

** Record not computed

+ Less than 0.05 acre feet or less than 0.05 cfs, but greater than 0

RUNOFF – STREAM GAGING STATION PEAK FLOW

**SAN GABRIEL RIVER below Santa Fe Dam.
STATION NO. E281-R**

Season	Daily CFS			Total Runoff (Acre-feet)	Peak Flow	
	Maximum	Minimum	Mean		Date	CFS
1998-99	251	0	7.2	5,240		N.D.
1999-00	61	0	7.4	5,380	May 12	129
2000-01	129	0	0.8	611	Feb 12	306
2001-02	394	0	3.8	2,791	Nov 24	903
2002-03	73	0	2	1,453	Aug 25	185
2003-04	93	0	1.2	896	Dec 25	284
2004-05	14,700	0	441	320,000	Jan 09	26,100
2005-06	409	0	11	7,930	Nov 09	475
2006-07	0	0	0	0		
2007-08	279	0	17.2	12,457	Jul 22	425
2008-09	209	0	1.5	1,080	Nov 26	544
2009-10	438	0	22.8	16,520	May 03	486
2010-11	592	0	60.4	43,740	Jul 14	702
2011-12	66	0	0.18	130	Nov 29	197
2012-13	ND	ND	ND	ND	ND	ND
2013-14	ND	ND	ND	ND	ND	ND
2014-15	ND	ND	ND	ND	ND	ND

M Data missing

* Record incomplete

E Estimate

N.D. Not determined

** Record not computed

+ Less than 0.05 acre feet or less than 0.05 cfs, but greater than 0

RUNOFF – STREAM GAGING STATION PEAK FLOW

**SAN GABRIEL RIVER below Cogswell Dam.
STATION NO. F209-R**

Season	Daily CFS			Total Runoff (Acre-feet)	Peak Flow	
	Maximum	Minimum	Mean		Date	CFS
1933-34	1,758	0	12.5	9,140	Jan 01	4,401
1934-35	594	0.1	27.5	19,701	Dec 13	1,260
1935-36	43	0.2	9.8	7,089	Feb 17	45
1936-37	577	0.1	46.9	33,585	Feb 14	752
1937-38	6,620	0.7	80.2	58,918	Mar 02	25,000
1938-39	683	0.4	15.7	11,359	Sep 25	1,190
1939-40	141	0.6	13	9,374	Jan 15	1,240
1940-41	1,130	0.5	83.7	59,817	Feb 22	1,160
1941-42	76	1	9.3	7,294	Nov 01	90
1942-43	4,775	0.6	75.8	54,927	Feb 23	7,300
1943-44	805	2.2	52.2	37,702	Dec 28	1,210
1944-45	144	0.8	14.6	10,411	Nov 20	157
1945-46	602	0.8	22.7	16,478	Mar 30	814
1946-47	1,110	0.1	27.9	20,245	Jan 06	1,240
1947-48	28	0.1	4.8	3,045	May 17	79
1948-49	12	0.1	4.5	2,775	Jul 21	67
1949-50	13	0.1	4.9	3,552	Mar 02	84
1950-51	11	0.2	0.8	576	Oct 24	52
1951-52	1,240	0.1	35.4	25,874	Jan 18	2,000
1952-53	289	0.1	17	12,479	Jan 09	328
1953-54	144	0.1	10.5	7,552	Jan 26	146
1954-55	36	0.1	4.4	3,193	Oct 04	149
1955-56	16	0.1	5	3,626		
1956-57	139	0.1	5.3	3,789	Nov 09	260
1957-58	1,170	0.1	48.3	34,531	Apr 04	1,430
1958-59	120	0.2	8.8	6,245	Feb 16	124
1959-60	13	0.1	2.8	2,018	Jan 29	260
1960-61	6	0.1	0.8	579	Jan 11	336
1961-62	1,810	0.1	34.5	23,811	Feb 11	2,370
1962-63	N.D.					
1963-64	30	0.1	3.7	2,661	Jun 24	788
1964-65	47	0.1	5.8	4,170	Apr 09	53
1965-66	1,120	0.3	56.9	41,365	Nov 22	2,570

M Data missing

* Record incomplete

E Estimate

N.D. Not determined

** Record not computed

+ Less than 0.05 acre feet or less than 0.05 cfs, but greater than 0

RUNOFF – STREAM GAGING STATION PEAK FLOW

**SAN GABRIEL RIVER below Cogswell Dam.
STATION NO. F209-R**

Season	Daily CFS			Total Runoff (Acre-feet)	Peak Flow	
	Maximum	Minimum	Mean		Date	CFS
1966-67	1,040	0.3	45.1	32,757	Dec 06	2,460
1967-68	N.D.					
1968-69	N.D.					
1969-70	N.D.					
1970-71	N.D.					
1971-72	N.D.					
1972-73	N.D.					
1973-74	N.D.					
1974-75	34	2	11.5	8,299	Oct 24	34
1975-76	33	2	6.9	4,999	Sep 15	33
1976-77	29	1.4	6.9	5,021	Oct 02	29
1977-78	3,550	1.9	3.9	86,060	Mar 04	8,780
1978-79	495	2.3	33.3	24,094	Mar 27	510
1979-80	1,920	2.5	81.5	33,673	Feb 19	2,760
1980-81	235	0.4	10.6	7,704	Apr 13	1,330
1981-82	1,110	0.4	12.5	9,059	Mar 23	3,910
1982-83	3,470	5.3	3.5	78,268	Mar 02	4,680
1983-84	115	4.4	0.6	12,497	Dec 28	190
1984-85	94	1.3	8.8	6,352	Jan 09	102
1985-86	535	4.6	21.2	15,314	Mar 19	1,140
1986-87	62	2.8	91.3	2,807	Nov 12	619
1987-88	202	2.3	19.7	11,249	Jan 27	756
1988-89	39	2.1	7.5	4,681	Feb 24	62
1989-90	7	1.4	2.4	1,718		
1990-91	390	1	15.3	10,934	Apr 03	417
1991-92	1,770	0.1	47.5	34,449	Feb 12	M
1992-93	1,360	1	109	79,251	Jan 14	1,550
1993-94	85	1	14.3	10,319	Dec 02	86
1994-95	951	0.5	56.7	41,044	Jan 10	1,740
1995-96	466	0.1	14.6	10,600	Feb 21	938
1996-97	335	0.1	11.2	8,085	Jan 22	651
1997-98	1,760	4.7	57.2	41,406	Feb 24	2,590
1998-99	184	2.5	17.2	12,431	Dec 01	935

M Data missing

* Record incomplete

E Estimate

N.D. Not determined

** Record not computed

+ Less than 0.05 acre feet or less than 0.05 cfs, but greater than 0

RUNOFF – STREAM GAGING STATION PEAK FLOW

SAN GABRIEL RIVER below Cogswell Dam.
STATION NO. F209-R

Season	Daily CFS			Total Runoff (Acre-feet)	Peak Flow	
	Maximum	Minimum	Mean		Date	CFS
1999-00	14	0.5	7.4	5,400	Feb 20	47
2000-01	22	7.6	14.4	10,410	Feb 13	37
2001-02	14	0.8	5.4	3,931	Nov 13	26
2002-03	25	0.3	11.5	8,285	May 28	232
2003-04	34	0.8	9.3	6,783	Oct 29	330
2004-05	3,220	1.6	134	96,800	Jan 11	5,370
2005-06	69	12	22.4	15,130	May 09	69
2006-07	13	0.8	3.7	2,657	Oct 17	17
2007-08	33	0.6	18.6	13,527	Aug 21	104
2008-09	28	2.2	8.6	6,230	Jun 17	2,950
2009-10	411	0.4	38.6	27,930	Feb 06	1,270
2010-11	1,330	8.7	97.2	70,360	Dec 22	1,450
2011-12	209	1.07	14.2	10,190	Oct 18	220
2012-13	10	0	2.46	1,770	Aug 26	2,010
2013-14	3.11	0.41	1.17	842	May 23	11.8
2014-15	3.75	0	1.71	1,230	Feb 23	45.7

M Data missing

* Record incomplete

E Estimate

N.D. Not determined

** Record not computed

+ Less than 0.05 acre feet or less than 0.05 cfs, but greater than 0

RUNOFF – STREAM GAGING STATION PEAK FLOW

**SAN GABRIEL RIVER above Whittier Narrow Dam.
STATION NO. G44B-R**

Season	Daily CFS			Total Runoff (Acre-feet)	Peak Flow	
	Maximum	Minimum	Mean		Date	CFS
1991-92*	1,080	0	18.7	13,303		
1992-93	8,940	0	331	239,551		
1993-94	1,030	0	19.2	13,929	Mar 24	8,650
1994-95	6,130	0	112	80,834	Jan 10	29,600
1995-96	5,280	0	33.9	24,639	Feb 20	19,700
1996-97	2,300	0	31.7	22,917	Dec 09	7,130
1997-98	7,200	0	107	77,632	Feb 07	28,900
1998-99	355	0	4.3	3,136	Nov 08	3,700
1999-00*	1,510	0	23.2	16,816	Feb 23	11,700
2000-01	2,360	0	28.3	20,490	Jan 11	9,210
2001-02	1,063	0	3.5	2,563	Nov 24	21,429
2002-03	3,907	0	48.8	35,378	Dec 16	22,100
2003-04	3,475	0	28	20,670	Feb 26	15,600
2004-05	18,200	0	374	271,000	Jan 09	26,900
2005-06	1,470	0	17.2	12,480	Mar 28	10,027
2006-07	592	13.4	309	2,451	Apr 20	4,837
2007-08	3,040	0	34.7	25,223	Jan 05	16,795
2008-09	1,860	0	26.8	19,390	Feb 05	17,000
2009-10	3,380	0	41.7	30,150	Jan 20	19,500
2010-11	4,510	0	76	55,040	Dec 22	22,700
2011-12	1,010	0	12.7	9,190	Oct 05	6,750
2012-13	263	0	1.53	1,110	Dec 03	1,010
2013-14	1,640	0	5.76	4,170	Feb 28	7,320
2014-15	975	0	10.1	7,350	Dec 02	6,750

M Data missing

* Record incomplete

E Estimate

N.D. Not determined

** Record not computed

+ Less than 0.05 acre feet or less than 0.05 cfs, but greater than 0

RUNOFF – STREAM GAGING STATION PEAK FLOW

**SAN GABRIEL RIVER below Morris Dam.
STATION NO. U8-R**

Season	Daily CFS			Total Runoff (Acre-feet)	Peak Flow	
	Maximum	Minimum	Mean		Date	CFS
1895-96	134	0	N.D.	N.D.		
1896-97	1,760	0	95.6	69,200		N.D.
1897-98	1,600	0	9.6	6,920		N.D.
1898-99	16	0	0.1	74		N.D.
1899-00	49	0	0.4	272		N.D.
1900-01	5,170	0	94.1	68,100	Feb 05	N.D.
1901-02	318	0	4.3	3,100		6,250
1902-03	2,940	0	104	74,900		N.D.
1903-04	1,070	0	9.3	6,720		N.D.
1904-05	2,940	0	172	124,000		N.D.
1905-06	7,950	0	262	190,000		N.D.
1906-07	6,730	0	406	293,000		N.D.
1907-08	1,160	0	46.4	33,700		N.D.
1908-09	7,030	0	197	143,000		N.D.
1909-10	12,400	0	137	99,100	Jan 01	13,900
1910-11	9,100	0	321	231,000	Mar 10	13,500
1911-12	2,950	0	55.5	40,300		N.D.
1912-13	1,880	0	25.6	18,600		N.D.
1913-14	11,800	0	359	260,000	Feb 20	18,100
1914-15	1,110	0	108	77,900	Jan 29	2,770
1915-16	22,300	0	315	228,000	Jan 18	40,000
1916-17	3,900	0	49.3	35,700		N.D.
1917-18	4,940	0	123	88,600	Mar 17	8,680
1918-19	76	0	3.2	2,290	Feb 11	230
1919-20	2,400	0	94.6	68,700	Mar 02	5,000
1920-21	2,050	0	40.1	29,000	Mar 14	4,000
1921-22	16,000	0	505	365,000	Dec 19	22,300
1922-23	2,250	0	44	31,800	Dec 13	3,670
1923-24	253	0	3.5	2,540	Mar 26	510
1924-25	588	0	4.2	3,030	Mar 04	3,000
1925-26	5,530	0	113	81,700	Apr 07	14,900
1926-27	11,400	0	123	88,900	Feb 16	18,200

M Data missing

* Record incomplete

E Estimate

N.D. Not determined

** Record not computed

+ Less than 0.05 acre feet or less than 0.05 cfs, but greater than 0

RUNOFF – STREAM GAGING STATION PEAK FLOW

**SAN GABRIEL RIVER below Morris Dam.
STATION NO. U8-R**

Season	Daily CFS			Total Runoff (Acre-feet)	Peak Flow	
	Maximum	Minimum	Mean		Date	CFS
1927-28	672	0	4.1	2,940	Feb 04	1,810
1928-29	411	0	10	7,210	Mar 10	895
1929-30	396	0	21.5	15,600	Mar 15	586
1930-31	601	0	9.5	6,900	Apr 26	1,450
1931-32	5,830	0	120	87,200	Feb 09	7,500
1932-33	1,630	0	21.9	15,900	Jan 19	5,820
1933-34	2,380	0	30.4	22,080	Jan 01	6,120
1934-35	460	0	102	74,080	Feb 09	507
1935-36	224	0	31.6	22,980	Apr 10	455
1936-37	1,770	0	195	141,100	Feb 20	1,950
1937-38	21,660	0.1	415	300,200	Mar 02	65,700
1938-39	316	6.5	53.5	38,680		N.D.
1939-40	506	0	50.5	36,640	Jun 24	506
1940-41	3,870	0	317	229,300	Mar 04	4,460
1941-42	370	2.5	13.1	9,480	Apr 20	422
1942-43	10,370	2	334	242,000	Jan 23	12,100
1943-44	2,710	3.6	184	133,700	Feb 22	5,170
1944-45	980	6.1	62.8	45,490	Feb 06	988
1945-46	937	0.3	75.9	54,930	Dec 23	980
1946-47	2,930	0	74.9	54,220	Dec 31	2,980
1947-48	1,170	0	18.1	13,170	Jun 02	1,320
1948-49	61	0	5.7	4,140	Oct 27	79
1949-50	8	0	0.7	51	Jul 31	8
1950-51	47	0	8.6	6,220	Apr 27	168
1951-52	3,530	0	91.1	66,120		N.D.
1952-53	1,190	0	69.4	50,240		N.D.
1953-54	960	0	34.6	25,030	Apr 16	9,420
1954-55	10	0	0.1	86	Sep 26	10
1955-56	43	0	0.2	176	Sep 30	45
1956-57	650	0	12.4	9,010	Apr 14	656
1957-58	2,470	0	241	174,100	Apr 05	2,780
1958-59	348	0	11.3	8,200	Feb 24	364

M Data missing

* Record incomplete

E Estimate

N.D. Not determined

** Record not computed

+ Less than 0.05 acre feet or less than 0.05 cfs, but greater than 0

RUNOFF – STREAM GAGING STATION PEAK FLOW

SAN GABRIEL RIVER below Morris Dam. STATION NO. U8-R

Season	Daily CFS			Total Runoff (Acre-feet)	Peak Flow	
	Maximum	Minimum	Mean		Date	CFS
1959-60	0	0	0	0		0
1960-61	8	0	1.7	1,250	May 06	9
1961-62	1,520	0	102	73,590	Feb 12	1,650
1962-63	27	0	1	712	Sep 04	45
1963-64	22	0	0.2	160	Aug 26	50
1964-65	276	0	10.7	981	Jun 12	291
1965-66	7,260	0	225	162,900	Nov 23	8,640
1966-67	3,750	0	232	167,900	Dec 06	5,680
1967-68	236	0	31.7	23,030	Nov 25	326
1968-69	19,300	0	750	543,000	Feb 25	29,850
1969-70	1,060	0	52.4	37,970	Feb 28	1,102
1970-71	434	0	31.4	22,760	Jan 04	439
1971-72	299	0	15.3	11,090	Dec 08	299
1972-73	849	0	131	94,790	Mar 19	918
1973-74	310	0	60.8	44,010	Nov 07	364
1974-75	248	0	29.7	21,500		248
1975-76	191	0	28.8	20,870	Mar 25	178
1976-77	267	0	21.8	15,760	Oct 13	273
1977-78	10,800	0	630.1	456,170	Mar 04	14,100
1978-79	504	0	149.2	108,000	Apr 22	519
1979-80	8,310	0	473.3	337,410	Feb 19	8,720
1980-81	415	0	37.8	27,335	Dec 11	514
1981-82	586	0	90.2	65,284	Mar 24	5,490
1982-83	11,600	0	15.9	352,733	Mar 02	11,900
1983-84	485	0	2.2	48,419	Oct 13	552
1984-85	464	0	48.5	35,100	Jan 01	469
1985-86	831	0	131	94,778	Feb 25	856
1986-87	186	0	60.8	43,995	Feb 23	212
1987-88	253	0	94.1	67,673	Jun 08	793
1988-89	434	0.4	68	49,058	Jan 05	434
1989-90	166	0.1	64	46,101	Apr 28	162
1990-91	785	0	113	80,999	Jul 28	793

M Data missing

* Record incomplete

E Estimate

N.D. Not determined

** Record not computed

+ Less than 0.05 acre feet or less than 0.05 cfs, but greater than 0

RUNOFF – STREAM GAGING STATION PEAK FLOW

**SAN GABRIEL RIVER below Morris Dam.
STATION NO. U8-R**

Season	Daily CFS			Total Runoff (Acre-feet)	Peak Flow	
	Maximum	Minimum	Mean		Date	CFS
1991-92	1,740	0.8	206	149,508	Feb 15	3,460
1992-93	9,500	0	655	474,300	Jan 14	9,500
1993-94	480	0	57.8	41,860	Aug 02	1,490
1994-95	*	*	*	*		*
1995-96	552	0.4	124	89,820	Sep 25	1,220
1996-97	696	0.3	90.3	65,340	Feb 02	1,620
1997-98	7,200	0	365	264,000	Feb 24	10,300
1998-99	250	0	33.1	23,970	Mar 01	3,140
1999-00	316	1.2	59.1	42,940	May 01	834
2000-01	490	2	65.3	47,240	May 09	1,240
2001-02	242	2.3	65.5	47,416	Oct 31	1,183
2002-03	747	1.9	118	85,273	Nov 14	1,070
2003-04	677	1.1	89	64,273	Oct 06	683
2004-05	15,900	21	748	541,000	Jan 11	20,700
2005-06	791	1.7	215	155,600	May 11	868
2006-07	176	1.3	28.1	20,346	Nov 16	176
2007-08	669	1.7	107.8	78,240	Jul 29	2,190
2008-09	659	0.7	35.2	25,480	Oct 07	1,990
2009-10	661	0	178	129,200	Apr 14	1,850
2010-11	1,210	3.09	341	246,600	Feb 25	1,780
2011-12	599	1.2	48.4	35,160	Nov 29	2,330
2012-13	304	0	30.6	22,150	Oct 15	305
2013-14	382	0	56.9	41,230	Nov 13	834
2014-15	87	0	43.8	31,690	Mar 12	982

M Data missing

* Record incomplete

E Estimate

N.D. Not determined

** Record not computed

+ Less than 0.05 acre feet or less than 0.05 cfs, but greater than 0

RUNOFF – STREAM GAGING STATION PEAK FLOW

**San Gabriel River – West Fork at Toe of Cogswell Dam.
STATION NO. F251-R**

Season	Daily CFS			Total Runoff (Acre-feet)	Peak Flow	
	Maximum	Minimum	Mean		Date	CFS
1934-35	20	0	4	2,890	May 01	20
1935-36	41	0.1	9.3	6,728	Feb 17	41
1936-37	N.D.					
1937-38	N.D.					
1938-39	N.D.					
1939-40	N.D.					
1940-41	N.D.					
1941-42	N.D.					
1942-43	N.D.					
1943-44	N.D.					
1944-45	N.D.					
1945-46	N.D.					
1946-47	N.D.					
1947-48	N.D.					
1948-49	N.D.					
1949-50	N.D.					
1950-51	N.D.					
1951-52	N.D.					
1952-53	N.D.					
1953-54	N.D.					
1954-55	N.D.					
1955-56	N.D.					
1956-57	N.D.					
1957-58	N.D.					
1958-59	N.D.					
1959-60	N.D.					
1960-61	N.D.					
1961-62	N.D.					
1962-63	N.D.					
1963-64	N.D.					
1964-65	N.D.					
1965-66	N.D.					
1966-67	N.D.					

M Data missing

* Record incomplete

E Estimate

N.D. Not determined

** Record not computed

+ Less than 0.05 acre feet or less than 0.05 cfs, but greater than 0

RUNOFF – STREAM GAGING STATION PEAK FLOW

**San Gabriel River – West Fork at Toe of Cogswell Dam.
STATION NO. F251-R**

Season	Daily CFS			Total Runoff (Acre-feet)	Peak Flow	
	Maximum	Minimum	Mean		Date	CFS
1967-68	N.D.					
1968-69	N.D.					
1969-70	N.D.					
1970-71	N.D.					
1971-72	N.D.					
1972-73	N.D.					
1973-74	N.D.					
1974-75	5	1.8	3.6	2,614	VARIOUS	5
1975-76	4	1.8	3.2	2,326	Feb 09	4
1976-77	5	1.8	3.1	2,228		
1977-78	17	2.2	0.2	4,131	Feb 10	57
1978-79	7	2.5	0.1	2,801	Mar 27	7
1979-80	N.D.					
1980-81	6	0	1.9	1,364	Oct 01	6
1981-82	10	0	5.1	3,683		10
1982-83	14	4.2	0.3	5,635	Mar 02	14
1983-84	8	1.5	0.2	3,383	Oct 01	8
1984-85	5	1	3.4	2,433	Dec 28	5
1985-86	5	2.9	4	2,877	Feb 15	6
1986-87	4	2.2	31.8	1,927	Oct 01	4
1987-88	4	1.8	35.5	2,142	May 23	4
1988-89	3	1.7	2	1,449	Oct 01	3
1989-90	3	1	1.9	1,344	May 19	3
1990-91	5	0	0.7	510	Mar 01	5
1991-92	5	0	0.8	570	Apr 08	5
1992-93	22	0.2	11	7,996	Jan 18	23
1993-94	11	0.2	3.1	2,243	Oct 01	11
1994-95	4	0	0.7	502	Aug 15	11
1995-96	2	0	0.1	66	Feb 21	6
1996-97	13	0	5.5	4,006	Apr 21	13
1997-98	31	2.4	16.1	11,655	Feb 23	39
1998-99	22	1.3	9.5	6,897	Oct 01	22
1999-00	12	0	4.3	3,102	Apr 18	12

M Data missing

* Record incomplete

E Estimate

N.D. Not determined

** Record not computed

+ Less than 0.05 acre feet or less than 0.05 cfs, but greater than 0

RUNOFF – STREAM GAGING STATION PEAK FLOW

**San Gabriel River – West Fork at Toe of Cogswell Dam.
STATION NO. F251-R**

Season	Daily CFS			Total Runoff (Acre-feet)	Peak Flow	
	Maximum	Minimum	Mean		Date	CFS
2000-01	14	1.8	7.6	5,520	Apr 07	14
2001-02	8	0	2.9	2,070	Nov 25	8
2002-03	14	0.3	5.8	4,190	Mar 24	14
2003-04	6	0.5	3.1	2,262	Mar 02	10
2004-05	34	1	18.6	13,500	Jan 10	35
2005-06	29	7.5	17.7	12,850	May 01	29
2006-07	10	0	3	2,154	Oct 01	10
2007-08	121	0.1	4.8	3,477	Jan 08	37
2008-09	9	0.2	2.2	1,560	Sep 05	33
2009-10	29	0.01	12.1	8,770	Jul 08	30
2010-11	22	3.2	10.7	7,730	May 04	22
2011-12	8	0.78	390	2,830	May 10	8
2012-13	5.52	0.01	1.49	1,080	May 30	6
2013-14	2.17	0.42	1.22	883	Oct 01	6.75
2014-15	1.99	0.75	1.5	1080	Jan 26	1.99

M Data missing

* Record incomplete

E Estimate

N.D. Not determined

** Record not computed

+ Less than 0.05 acre feet or less than 0.05 cfs, but greater than 0

RUNOFF – STREAM GAGING STATION PEAK FLOW

**SAN JOSE CHANNEL above Workman Mill Road.
STATION NO. F312B-R**

Season	Daily CFS			Total Runoff (Acre-feet)	Peak Flow	
	Maximum	Minimum	Mean		Date	CFS
1955-56	1,830	0	5.6	4,070	Jan 26	5,180
1956-57	190	0	1.1	795	Mar 01	1,410
1957-58	1,210	0	19.4	14,060	Apr 07	3,990
1958-59	487	0	4.4	3,210	Jan 06	2,720
1959-60	253	0	4.7	3,430	Apr 27	1,380
1960-61	103	0	0.6	403	Jan 26	429
1961-62	1,220	0	13.2	9,540	Feb 11	3,800
1962-63	581	0	7.6	5,530	Mar 16	1,940
1963-64	483	+	6.8	4,900	Jan 22	1,250
1964-65	1,080	0	14	10,110	Apr 09	4,540
1965-66	1,640	+	21.1	15,290	Dec 29	5,220
1966-67	2,290	2.8	36.3	26,260	Jan 24	10,200
1967-68	2,180	6.4	24.6	17,870	Mar 08	10,100
1968-69	4,370	9.3	73.2	52,980	Feb 25	9,710
1969-70	898	8	28.7	20,490	Mar 04	3,930
1970-71	1,180	5	22.4	16,190	Dec 21	4,400
1971-72	988	3.9	17.4	12,650	Dec 24	3,720
1972-73	1,820	7	38.4	27,830	Feb 13	6,440
1973-74	1,970	8	33.3	24,060	Jan 04	4,900
1974-75	1,260	5.2	64.4	46,650	Dec 04	9,620
1975-76	1,200	5	25.6	18,310	Sep 10	5,000
1976-77	816	3	23.2	16,820	Aug 17	3,580
1977-78	2,740	5	74	53,613	Mar 04	11,100
1978-79	2,420	5.6	43.9	31,812	Jan 31	7,330
1979-80	3,150	6.3	81.4	57,830	Feb 18	13,000
1980-81	1,240	12.6	96.2	69,674	Mar 01	4,810
1981-82	1,140	8.6	34.1	24,673	Mar 14	5,790
1982-83	2,720	11.8	65.8	47,646	Feb 27	19,200
1983-84	1,050	8.6	28.3	20,538	Oct 01	5,060
1984-85	927	8.6	38.6	27,929	Dec 18	5,330
1985-86	1,850	10.2	51.8	37,499	Feb 15	7,250
1986-87	1,900	7.8	38.4	27,787	Jan 04	6,980
1987-88	1,700	6.3	35.3	25,633	Jan 17	7,850

M Data missing

* Record incomplete

E Estimate

N.D. Not determined

** Record not computed

+ Less than 0.05 acre feet or less than 0.05 cfs, but greater than 0

RUNOFF – STREAM GAGING STATION PEAK FLOW

**SAN JOSE CHANNEL above Workman Mill Road.
STATION NO. F312B-R**

Season	Daily CFS			Total Runoff (Acre-feet)	Peak Flow	
	Maximum	Minimum	Mean		Date	CFS
1988-89	1,100	7.4	59.2	42,258	Dec 21	4,800
1989-90	3,060	7.8	80.6	58,322	Feb 17	7,700
1990-91	1,960	7.1	68	48,938	Mar 01	7,270
1991-92	2,370	7.3	83	60,221	Feb 11	16,800
1992-93	4,370*	7.0*	*	*	Jan 07	20,200
1993-94	*	*	*	*		*
1994-95	2,480	22.7	105	75,660	Jan 10	11,400
1995-96	1,630	0	44.4	32,260	Feb 20	10,100
1996-97	868	1.8	40.4	29,240	Jan 25	4,440
1997-98	1,760	11	70.7	51,170	Feb 07	14,500
1998-99	314	3.4	26.1	18,980	Nov 28	2,150
1999-00	1,220	6.9	81.1	58,900	Apr 18	6,480
2000-01	3,320E	6.9*	83.5E	60,440E		N.D.
2001-02	1,025	8.9	74.3	53,897	Nov 24	11,784
2002-03	1,983	8	61.7	44,691	Dec 16	9,720
2003-04	1,843	1.9	53	38,388	Feb 26	7,980
2004-05	2,390	9.2	114	82,700	Feb 19	10,500
2005-06	1,480	12	104	75,240	Jan 02	9,293
2006-07	565	9.4	71.3	51,638	Apr 20	3,230
2007-08	1,120	4	46.7	33,891	Jan 05	5,833
2008-09	1,020	7.2	36.5	26,430	Feb 05	11,200
2009-10	2,510	4.7	97.6	70,660	Jan 18	15,100
2010-11	2,860	3.54	103	74,490	Dec 22	12,900
2011-12	665	5.95	30.8	22,380	Mar 17	4,330
2012-13	377	4.74	22.6	16,350	Mar 08	2,160
2013-14	1,100	2.96	17.8	12,890	Feb 28	3,420
2014-15	712	2.49	25.6	18,510	Jul 19	4,850

M Data missing

* Record incomplete

E Estimate

N.D. Not determined

** Record not computed

+ Less than 0.05 acre feet or less than 0.05 cfs, but greater than 0

RUNOFF – STREAM GAGING STATION PEAK FLOW

SANTA ANITA CREEK below Santa Anita Dam.
STATION NO. F119C-R

Season	Daily CFS			Total Runoff (Acre-feet)	Peak Flow	
	Maximum	Minimum	Mean		Date	CFS
1935-36	52	0.1	3.5	2,530	N.D.	N.D.
1936-37	140	0.1	11.3	7,918	Feb 15	141
1937-38	56	0	6.6	1,856		
1938-39	N.D.				N.D.	N.D.
1939-40	N.D.				N.D.	N.D.
1940-41	N.D.				N.D.	N.D.
1941-42	N.D.				N.D.	N.D.
1942-43	N.D.				N.D.	N.D.
1943-44	N.D.				N.D.	N.D.
1944-45	N.D.				N.D.	N.D.
1945-46	N.D.				N.D.	N.D.
1946-47	N.D.				N.D.	N.D.
1947-48	N.D.				N.D.	N.D.
1948-49	N.D.				N.D.	N.D.
1949-50	24	0	1.8	1,312	N.D.	N.D.
1950-51	5	0	0.7	498	N.D.	N.D.
1951-52	345	0.5	11.4	8,293	N.D.	N.D.
1952-53	37	0.8	2.4	1,728	N.D.	N.D.
1953-54	145	0	4.8	3,412	N.D.	N.D.
1954-55	27	0	2	1,437	N.D.	N.D.
1955-56	113	0.3	3	2,196	Jan 29	120
1956-57	15	0.1	2	1,432	Jan 13	15
1957-58	249	0.6	16.3	11,706	N.D.	N.D.
1958-59	38	0	2.9	2,030	Feb 16	46
1959-60	25	0.1	1.6	1,143	Aug 01	114
1960-61	19	0	0.6	405	Jan 28	19
1961-62	265	0	7.7	5,358	Feb 11	1,350
1962-63	36	0	2.6	1,847	Feb 09	257
1963-64	31	0	1.6	1,151	Feb 11	289
1964-65	45	0	2.8	1,992	Apr 16	289
1965-66	N.D.				N.D.	N.D.
1966-67	N.D.				N.D.	N.D.
1967-68	N.D.				N.D.	N.D.

M Data missing

* Record incomplete

E Estimate

N.D. Not determined

** Record not computed

+ Less than 0.05 acre feet or less than 0.05 cfs, but greater than 0

RUNOFF – STREAM GAGING STATION PEAK FLOW

**SANTA ANITA CREEK below Santa Anita Dam.
STATION NO. F119C-R**

Season	Daily CFS			Total Runoff (Acre-feet)	Peak Flow	
	Maximum	Minimum	Mean		Date	CFS
1968-69	N.D.				N.D.	N.D.
1969-70	N.D.				N.D.	N.D.
1970-71	N.D.				N.D.	N.D.
1971-72	N.D.				N.D.	N.D.
1972-73	N.D.				N.D.	N.D.
1973-74	N.D.				N.D.	N.D.
1974-75	36	0.2	3.7	2,648	May 13	109
1975-76	34	0.2	2	1,469	Sep 27	9
1976-77	31	0.2	1.7	1,207	Sep 19	264
1977-78	727	0	30	21,712	N.D.	N.D.
1978-79	47	0.2	8.5	6,184	Jul 30	135
1979-80	600	0	25.5	18,435	N.D.	N.D.
1980-81	28	0.2	3.1	2,212	Jun 15	24
1981-82	123	0.2	5	3,653	Mar 17	141
1982-83	795	0.2	29.5	21,302	Mar 02	1,189
1983-84	34	0.2	5	3,587	Mar 22	157
1984-85	25	0.2	3.1	2,273	Feb 14	29
1985-86	32	0.2	6.4	4,653	Apr 29	232
1986-87	N.D.				N.D.	N.D.
1987-88	37	0	3.3	2,395	N.D.	N.D.
1988-89	28	0	2.1	1,439	Dec 20	28
1989-90	24	0	1	710	N.D.	N.D.
1990-91	103	0	3.2	2,353	Mar 01	103
1991-92	459	0	13.3	9,640	Feb 11	592
1992-93*	16	0	3.1	929	N.D.	N.D.
1993-94	22	0	2	1,419	May 26	146
1994-95	237	0	16.8	12,190	Jan 11	408
1995-96	219	0	6.1	4,427	Feb 21	310
1996-97	75	0	6.8	4,900	Oct 30	146
1997-98	155	0	14.5	10,510	May 13	155
1998-99*	20	0	2.7	1,920	N.D.	N.D.
1999-00	50	0	2.8	2,050	Feb 21	135
2000-01	97	0	2.9	2,090	Jun 28	298

M Data missing

* Record incomplete

E Estimate

N.D. Not determined

** Record not computed

+ Less than 0.05 acre feet or less than 0.05 cfs, but greater than 0

RUNOFF – STREAM GAGING STATION PEAK FLOW

SANTA ANITA CREEK below Santa Anita Dam.
STATION NO. F119C-R

Season	Daily CFS			Total Runoff (Acre-feet)	Peak Flow	
	Maximum	Minimum	Mean		Date	CFS
2001-02	23	0	2.1	1,392	Oct 25	136
2002-03	0	0	3.4	0	Mar 16	143
2003-04	69	0	2.1	1,523	Dec 05	300
2004-05	1,330	0	37	26,800	Jan 11	1,250
2005-06	53	0	6	4,370	May 25	222
2006-07	24	+	1.9	1,239	Mar 29	204
2007-08	165	0.3	7.9	5,680	Jan 06	239
2008-09	35	0.8	4	2,930	Feb 09	205
2009-10	47	+	6.3	4,550	Feb 06	174
2010-11	192	0.01	12.3	8,910	Dec 19	427
2011-12	47	0	2.95	2,140	Apr 03	73
2012-13	46	0	0.77	560	Jan 24	358
2013-14	13.2	0	0.61	445	Feb 25	31.4
2014-15	17.6	0	0.64	466	Dec 29	52.4

M Data missing

* Record incomplete

E Estimate

N.D. Not determined

** Record not computed

+ Less than 0.05 acre feet or less than 0.05 cfs, but greater than 0

RUNOFF – STREAM GAGING STATION PEAK FLOW

**SANTA ANITA WASH below Foothill Blvd.
STATION NO. F260C-R**

Season	Daily CFS			Total Runoff (Acre-feet)	Peak Flow	
	Maximum	Minimum	Mean		Date	CFS
1935-36	0	0	0			
1936-37	140	0	10	6,448	Feb 15	174
1937-38	468	0	3.4	2,330		
1938-39	46	0	2	1,471	Jan 05	128
1939-40	58	0	1.6	1,062	Jan 08	248
1940-41	262	0	18.1	12,931	Mar 04	482
1941-42	26	0	1	693	Dec 29	65
1942-43	2,130	0	30	21,674	Jan 23	3,800
1943-44	395	0	8.7	6,139	Feb 22	747
1944-45	92	0	2.3	1,540	Jun 25	225
1945-46	182	0	2	1,480	Dec 23	350
1946-47	144	0	3.4	2,489	Dec 29	289
1947-48	N.D.					
1948-49	N.D.					
1949-50	N.D.					
1950-51	N.D.					
1951-52	N.D.					
1952-53	N.D.					
1953-54	N.D.					
1954-55	N.D.					
1955-56	N.D.					
1956-57	N.D.					
1957-58	254	0	8.9	6,317		
1958-59	66	0	0.7	475	Jan 06	1,000
1959-60	10	0	0.2	161	Jan 11	194
1960-61	10	0	0.1	96	Nov 05	257
1961-62	584	0	7.3	4,983	Feb 11	1,440
1962-63	43	0	0.6	408	Feb 09	257
1963-64	32	0	0.6	423	Jan 22	335
1964-65	27	0	0.6	447	Apr 16	267
1965-66	481	0	10.5	7,589	Dec 29	1,260
1966-67	489	0	14.8	10,772	Dec 06	914
1967-68	N.D.					

M Data missing

* Record incomplete

E Estimate

N.D. Not determined

** Record not computed

+ Less than 0.05 acre feet or less than 0.05 cfs, but greater than 0

RUNOFF – STREAM GAGING STATION PEAK FLOW

**SANTA ANITA WASH below Foothill Blvd.
STATION NO. F260C-R**

Season	Daily CFS			Total Runoff (Acre-feet)	Peak Flow	
	Maximum	Minimum	Mean		Date	CFS
1968-69	N.D.					
1969-70	N.D.					
1970-71	N.D.					
1971-72	N.D.					
1972-73	N.D.					
1973-74	N.D.					
1974-75	43	0	0.5	379	Dec 04	477
1975-76	54	0	0.8	584	Feb 09	209
1976-77	36	0	0.6	415	Oct 23	437
1977-78	937	0	41.6	30,147	Feb 10	2,030
1978-79	29	0	2.3	1,686	Feb 21	335
1979-80	N.D.					
1980-81	40	0	0.9	652	Mar 19	411
1981-82	100	0	2.8	2,019	Mar 17	346
1982-83	773	0	30.2	21,840	Mar 02	1,340
1983-84	62	0	5.7	4,151	Nov 01	398
1984-85	110	0	4.5	3,283	Dec 19	378
1985-86	913	0	0	0		
1986-87	64	0	2	1,415	Jan 04	424
1987-88	41	0	1.3	939	Jan 17	975
1988-89	22	0	1	674	Dec 16	91
1989-90	28	0	0.7	537	Feb 17	189
1990-91	53	0	0.8	570	Feb 28	323
1991-92	593	0	27.7	20,116	Feb 12	1,110
1992-93	572	0	33.8	24,439	Jan 18	905
1993-94	59	0	5.8	4,192	Feb 17	175
1994-95	215	0	15.7	11,369	Mar 10	517
1995-96	236	0	9.4	5,846		
1996-97	86	0	4.8	3,455	Jan 26	252
1997-98	429	0	11.6	8,367		N.D.
1998-99	3	0	0.1	49	Jan 26	76
1999-00	63	0	1.7	1,258	Feb 21	479
2000-01	89	0	1.3	930	Jun 28	264

M Data missing

* Record incomplete

E Estimate

N.D. Not determined

** Record not computed

+ Less than 0.05 acre feet or less than 0.05 cfs, but greater than 0

RUNOFF – STREAM GAGING STATION PEAK FLOW

**SANTA ANITA WASH below Foothill Blvd.
STATION NO. F260C-R**

Season	Daily CFS			Total Runoff (Acre-feet)	Peak Flow	
	Maximum	Minimum	Mean		Date	CFS
2001-02	2	0	0.6	426	Nov 24	22
2002-03	4	0	0.1	10	Mar 15	195
2003-04	64	0	0.8	566	Feb 26	331
2004-05	1,210	0	23.6	17,100	Jan 10	1,740
2005-06	30	0	1.3	971	Jan 02	422
2006-07	5	0.2	0.5	394	Feb 27	122
2007-08	88	0	1.9	1,355	Jan 04	553
2008-09	31	0	0.8	618	Feb 16	286
2009-10	58	0	1.5	1,050	Feb 06	450
2010-11	158	0	6.1	4,410	Dec 22	663
2011-12	13	0	0.49	355	Apr 13	306
2012-13	7	0	0.22	158	Oct 11	180
2013-14	14.9	0	0.094	68	Feb 28	171
2014-15	9.8	0	0.17	121	Dec 12	581

M Data missing

* Record incomplete

E Estimate

N.D. Not determined

** Record not computed

+ Less than 0.05 acre feet or less than 0.05 cfs, but greater than 0

RUNOFF – STREAM GAGING STATION PEAK FLOW

**SANTA ANITA WASH at Longden Avenue.
STATION NO. F193B-R**

Season	Daily CFS			Total Runoff (Acre-feet)	Peak Flow	
	Maximum	Minimum	Mean		Date	CFS
1959-60	55	+	0.6	465	Apr 27	534
1960-61	33	0	0.3	216	Nov 12	314
1961-62	693	0	8.2	5,910	Feb 11	1,780
1962-63	101	0	1	709	Feb 09	621
1963-64	47	0	0.9	650	Nov 20	581
1964-65	63	0	1.4	985	Apr 09	518
1965-66	541	+	12	8,730	Dec 29	1,380
1966-67	613	+	16	11,570	Dec 06	1,180
1967-68	111	+	1.7	1,230	Nov 19	816
1968-69	2,760	+	46.9	33,930	Jan 25	6,850
1969-70	150	+	3.2	2,300	Mar 02	1,290
1970-71	350	+	3.4	2,440	Dec 21	590
1971-72	71	0	0.4	320	Dec 24	324
1972-73	595	0	5.9	4,270	Feb 27	1,630
1973-74	158	+	2.9	2,090	Jan 07	518
1974-75	95	0	1.2	875	Dec 04	943
1975-76	82	0	1.5	1,060	Sep 11	766
1976-77	46	0	1	752	Oct 23	694
1977-78	877	0	35.5	25,720	Feb 10	2,350
1978-79	1,160	0.1	12.4	8,978	Feb 21	1,730
1979-80	1,690	0.1	72.1	51,148	Jan 29	2,090
1980-81	121	0	1.3	963	Jan 29	1,100
1981-82	176	0	3.4	2,485	Mar 17	1,060
1982-83	958	0	79.5	57,533	Mar 02	2,240
1983-84	143	0.1	8.9	6,453	Nov 01	656
1984-85	93	0	3	2,142	Dec 19	517
1985-86	104	0.2	6.9	4,987	Feb 14	379
1986-87	27	0	0.6	454	Oct 02	858
1987-88	82	0	1.6	1,156	Jan 17	858
1988-89	42	0	1	717	Dec 16	180
1989-90	77	0	0.8	617	Jan 13	463
1990-91	104	0	2.2	1,602	Mar 01	490
1991-92	498	0	19.2	13,964	Feb 12	1,320

M Data missing

* Record incomplete

E Estimate

N.D. Not determined

** Record not computed

+ Less than 0.05 acre feet or less than 0.05 cfs, but greater than 0

RUNOFF – STREAM GAGING STATION PEAK FLOW

**SANTA ANITA WASH at Longden Avenue.
STATION NO. F193B-R**

Season	Daily CFS			Total Runoff (Acre-feet)	Peak Flow	
	Maximum	Minimum	Mean		Date	CFS
1992-93	552	0	35.7	25,860	Jan 18	1,370
1993-94	354	0	2.2	1,623	Apr 27	404
1994-95	375	0	19.2	13,920	Jan 10	1,070
1995-96	299	0	4.5	3,257	Jan 31	1,550
1996-97	89	+	5.7	4,110	Jan 26	443
1997-98	910	+	22.1	16,010	Feb 06	883
1998-99	34	0	1	717	Jan 26	230
1999-00	71	+	2.1	1,510	Feb 21	581
2000-01	86	+	2.9	2,110	Jan 11	430
2001-02	44	0	1.1	813	Nov 24	611
2002-03	114	0	2.7	1,922	Feb 13	741
2003-04	138	0	1.7	1,260	Feb 26	664
2004-05	1,650	0	42.8	31,000	Jan 10	2,610
2005-06	242	0	4.2	3,040	Jan 02	840
2006-07	32	0	0.9	645	Feb 11	289
2007-08	230	0	15.5	11,220	Jan 04	1,250
2008-09	66	0	2	1,420	Feb 16	656
2009-10	190	0	4.6	3,350	Jan 18	742
2010-11	381	0.4	13.6	9,880	Dec 22	996
2011-12	33	0	1.52	1,100	Mar 17	538
2012-13	25	0	1.02	737	Mar 08	256
2013-14	70.3	0	0.59	425	Feb 28	411
2014-15	43.0	0	0.86	621	Dec 12	799

M Data missing

* Record incomplete

E Estimate

N.D. Not determined

** Record not computed

+ Less than 0.05 acre feet or less than 0.05 cfs, but greater than 0

RUNOFF – STREAM GAGING STATION PEAK FLOW

**SANTA CLARA RIVER at Old Road Bridge.
STATION NO. F92C-R**

Season	Daily CFS			Total Runoff (Acre-feet)	Peak Flow	
	Maximum	Minimum	Mean		Date	CFS
1930-31	291	0.1	2.6	1,890	Feb 07	2,310
1931-32	739	0.1	5.9	4,280	Feb 09	2,090
1932-33	90	0	0.7	488	Jan 19	618
1933-34	448	+	2.2	1,600	Jan 01	3,870
1934-35	82	+	1.5	1,090	Jan 05	608
1935-36	113	0	2.2	1,590	Feb 23	833
1936-37	471	0	6.7	4,850	Dec 27	3,410
1937-38	6,370	+	37.2	26,900	Mar 02	24,000E
1938-39	435E	+	14.4	10,410	Dec 15	4,620
1939-40	79	0.3	2.2	1,570	Feb 01	676
1940-41	3,450	0.3	57.1	41,320	Mar 04	5,050
1941-42	167	0.6	32.3	23,400	Dec 28	443
1942-43	5,420	1.4	65.2	47,170	Jan 23	15,000
1943-44	9,360	2	68.6	49,770	Feb 22	22,200
1944-45	110	2.2	15.3	11,050	Feb 02	317
1945-46	194	0.4	8.9	6,440	Mar 30	500
1946-47	371	1	15.4	11,150	Dec 26	1,620
1947-48	33.0E	0.8	3.1	2,270	Mar 24	350E
1948-49	5	0.4	1.8	1,300	Mar 11	10
1949-50	5	0.1	1.2	888	Feb 06	9
1950-51	2	+	0.3	217	Jan 29	6
1951-52	1,620	+	23.1	16,760	Jan 16	7,600
1952-53	43	0.1	0.8	592	Dec 01	N.D.
1953-54	104	+	1.6	1,160	Jan 19	626
1954-55	96	+	0.8	612	Jan 18	746
1955-56	184	+	1.4	1,000	Jan 26	344
1956-57	195	0	1.4	1,020	Feb 28	1,920
1957-58	1,440	0	14.7	10,620	Apr 03	3,850
1958-59	215	0	1.3	940	Jan 06	1,410
1959-60	12	0	0.4	288	Apr 27	151
1960-61	58	0	0.7	533	Nov 05	830
1961-62	1,690	0	14.5	10,470	Feb 12	4,250
1962-63	105	0	1.3	965	Mar 16	1,470

M Data missing

* Record incomplete

E Estimate

N.D. Not determined

** Record not computed

+ Less than 0.05 acre feet or less than 0.05 cfs, but greater than 0

RUNOFF – STREAM GAGING STATION PEAK FLOW

**SANTA CLARA RIVER at Old Road Bridge.
STATION NO. F92C-R**

Season	Daily CFS			Total Runoff (Acre-feet)	Peak Flow	
	Maximum	Minimum	Mean		Date	CFS
1963-64	85	0	1.1	780	Jan 22	860
1964-65	240	0	2.1	1,550	Apr 08	1,260
1965-66	3,200	0	22	15,990	Dec 29	11,600
1966-67	820	+	9.8	7,100	Jan 24	3,000
1967-68	475	0	4.2	3,070	Jan 24	2,810
1968-69	N.D.	0.2	**	30,170E	Feb 25	31,800E
1969-70	164	1	13.3	9,610	Mar 01	900
1970-71	1,830	0.5	15.1	10,930	Nov 29	8,150
1971-72	442	0.5	9.2	6,640	Dec 27	2,200
1972-73	1,470	0.4	13	9,450	Feb 11	4,760
1973-74	984	1	9.1	6,600	Jan 07	2,440
1974-75	187	0.9	5.4	3,910	Dec 04	1,120
1975-76	138	+	3.7	2,710	Sep 10	999
1976-77	273	+	3.8	2,750	May 08	2,510
1977-78	*	*	*	*	Feb 10	*
1978-79	605	1	16	11,617	Mar 28	3,370
1979-80	*	*	*	*		*
1980-81	NO RECORD					
1981-82	NO RECORD					
1982-83	5,214	0.8	113.8	83,154	Mar 01	14,925
1983-84	*	*	*	*		*
1984-85	295	1	18.8	13,558	Dec 19	1,820
1985-86	492	7.5	24.7	17,896	Feb 14	1,050
1986-87	71	5.2	14.3	10,197	Nov 18	444
1987-88	485	0	16.5	11,981	Dec 04	1,450
1988-89	145	3.7	11.9	8,535	Dec 16	876
1989-90	18	4.9	12.2	8,864	Feb 17	523
1990-91	604	2.4	13.9	10,058	Mar 01	2,750
1991-92	*	*	*	*		*
1992-93	*	*	*	*		*
1993-94	*	*	*	*		*
1994-95	*	*	*	*		*
1995-96	*	*	*	*		*

M Data missing

* Record incomplete

E Estimate

N.D. Not determined

** Record not computed

+ Less than 0.05 acre feet or less than 0.05 cfs, but greater than 0

RUNOFF – STREAM GAGING STATION PEAK FLOW

**SANTA CLARA RIVER at Old Road Bridge.
STATION NO. F92C-R**

Season	Daily CFS			Total Runoff (Acre-feet)	Peak Flow	
	Maximum	Minimum	Mean		Date	CFS
1996-97	181	1.9	8.6	6,190	Dec 22	2,000
1997-98	7,080	1.3	89.2	53,800	Feb 23	19,000
1998-99	136	4.3	15.7	11,330	Jan 31	1,610
1999-00	1,300	3	18.7	13,600	Feb 23	8,770
2000-01	27	2.6	7.8	5,620	Jan 24	30
2001-02	17	2.2	5.2	2,350	Feb 17	38
2002-03	0	0	13.1	0	Feb 12	7,290
2003-04	990	0.4	6.8	4,940	Feb 26	5,900
2004-05	7,580	0.7	125	90,270	Jan 09	20,900
2005-06	117	1.4	7	4,420	Jan 02	707
2006-07	16	1.6	4.8	3,489	Mar 21	217
2007-08	192	1.3	7.6	5,526	Jan 27	560
2008-09	27	1.2	3.4	2,480	Feb 16	168
2009-10	6	1.3	2.9	2,140	Jan 20	55
2010-11	171	1.92	7.06	5,110	Mar 31	1,690
2011-12	10	1.45	4.04	2,940	Apr 18	42
2012-13	4	1.42	2.19	1,580	Jan 02	4
2013-14	448	1.1	4.65	3,140	Nov 21	793
2014-15						

M Data missing

* Record incomplete

E Estimate

N.D. Not determined

** Record not computed

+ Less than 0.05 acre feet or less than 0.05 cfs, but greater than 0

RUNOFF – STREAM GAGING STATION PEAK FLOW

**SANTA CLARA RIVER Above Lang Railroad Station.
STATION NO. F93B-R**

Season	Daily CFS			Total Runoff (Acre-feet)	Peak Flow	
	Maximum	Minimum	Mean		Date	CFS
1949 50	5	0.8	1.5	1,110	Feb 01	6
1950 51	2	0.6	1.1	774	Apr 01	2
1951 52	1,280	0.5	29.3	21,230	Jan 01	4,200
1952 53	9	1.2	3.1	2,250	Nov 01	39
1953 54	18	1	2.8	2,000	Jan 01	29
1954 55	5	1	1.8	1,270	Jan 01	6
1955 56	4	1	1.5	1,100	Apr 01	5
1956 57	2	0.9	1.3	906	Jan 01	2
1957 58	509	1	14.5	7,340	Apr 01	1,260
1958 59	21	1.1	2.5	1,780	Jan 01	40
1959 60	1	0.9	1.1	807		1
1960 61	46	0.3	1.4	980	Nov 01	500E
1961 62	308	0.2	5.8	4,190	Feb 01	500
1962 63	5	1.1	1.6	1,160	Feb 01	60
1963 64	1	0.6	1	697	Jan 01	70
1964 65	6	0.3	0.6	432	Apr 01	35
1965 66	942	0.4	12.7	9,240	Dec 01	4,040
1966 67	90	0.8	11.4	8,270	Jan 01	265
1967 68	38	0.3	2.8	2,000	Nov 01	200
1968 69	N.D.				Feb 01	5,900E
1969 70	60	0.1	5.3	3,860	Mar 01	200E
1970 71	195		6.2	4,510	Nov 01	620
1971 72	33	0	2.2	1,600	Dec 01	79
1972 73	458	0	5.1	3,670	Feb 01	953
1973 74	70	0	2.3	1,670	Jan 01	264
1974 75	13	0	1.1	813	Dec 01	59
1975 76	10	0	0.4	259	Feb 01	24
1976 77	9	0	0.2	147	May 01	38
1977 03	NO DATA	FROM 1977		TO 2003		
2003 04	15	0	0	30	Feb 04	87
2004 05	1,620	0	52.4	37,840	Jan 05	2,510
2005 06	77	0	4.66	2,960	Feb 06	120
2006 07	2	0.15	0	107	Aug 07	141

M Data missing

* Record incomplete

E Estimate

N.D. Not determined

** Record not computed

+ Less than 0.05 acre feet or less than 0.05 cfs, but greater than 0

RUNOFF – STREAM GAGING STATION PEAK FLOW

**SANTA CLARA RIVER Above Lang Railroad Station.
STATION NO. F93B-R**

Season	Daily CFS			Total Runoff (Acre-feet)	Peak Flow	
	Maximum	Minimum	Mean		Date	CFS
2007 08	52	0	1.64	1,200	Feb 08	97
2008-09	2	0	0.2	154	Oct 01	2
2009-10	10	0	1.7	1,270	Jul 03	15
2010-11	28	0	5.59	4,050	Mar 20	28
2011-12	15 E	0	1.44 E	1040 E	Apr 10	16 E
2012-13	0	0	0	0	ND	0

M Data missing

* Record incomplete

E Estimate

N.D. Not determined

** Record not computed

+ Less than 0.05 acre feet or less than 0.05 cfs, but greater than 0

RUNOFF – STREAM GAGING STATION PEAK FLOW

**SANTA CLARA RIVER At Capra Road Railroad Crossing
STATION NO. F93C-R**

Season	Daily CFS			Total Runoff (Acre-feet)	Peak Flow	
	Maximum	Minimum	Mean		Date	CFS
2013-14	51	0	0.3	214	Feb 28	288
2014-15	16	0	0.09	65	Jul 30	330

M Data missing

* Record incomplete

E Estimate

N.D. Not determined

** Record not computed

+ Less than 0.05 acre feet or less than 0.05 cfs, but greater than 0

RUNOFF – STREAM GAGING STATION PEAK FLOW

**SANTA FE DIVERSION CHANNEL below Santa Fe Dam.
STATION NO. F280-R**

Season	Daily CFS			Total Runoff (Acre-feet)	Peak Flow	
	Maximum	Minimum	Mean		Date	CFS
1943-44	253	0	20.9	15,180	May 18	253
1944-45	0	0	0	0		0
1945-46	479	0	31.2	22,610	Sep 13	484
1946-47	446	0	16.8	12,200	Nov 27	484
1947-48	786	0	10.9	7,880	Jun 04	800
1948-49	0	0	0	0		0
1949-50	0	0	0	0		0
1950-51	0	0	0	0		0
1951-52	381	0	3.2	2,280	Mar 16	732
1952-53	819	0	10.7	7,720	Nov 03	839
1953-54	750	0	11.5	8,350	May 07	752
1954-55	0	0	0	0		0
1955-56	0	0	0	0		0
1956-57	452	0	4.7	3,400	Apr 16	455
1957-58	621	0	27	19,530	Apr 04	635
1958-59	0	0	0	0		0
1959-60	0	0	0	0		0
1960-61	0	0	0	0		0
1961-62	547	0	12.7	9,190	Feb 12	819
1962-63	0	0	0	0		0
1963-64	0	0	0	0		0
1964-65	+	0	+	+	Sep 08	1
1965-66	348	0	10.4	7,540	Jan 07	425
1966-67	227	0	21.3	15,470	Dec 18	236
1967-68	1	0	+	33	Nov 20	1
1968-69	268	0	33.6	24,340	Apr 15	290
1969-70	55	0	1.9	1,360	Mar 03	202
1970-71	90	0	3.4	2,430	Dec 24	92
1971-72	95	0	1	697	Jan 19	116
1972-73	222	0	13	9,410	Feb 21	280
1973-74	233	0	6.4	4,650	Apr 16	241
1974-75	24	0	0.6	466	Apr 22	27
1975-76	0	0	0	0		0

M Data missing

* Record incomplete

E Estimate

N.D. Not determined

** Record not computed

+ Less than 0.05 acre feet or less than 0.05 cfs, but greater than 0

RUNOFF – STREAM GAGING STATION PEAK FLOW

**SANTA FE DIVERSION CHANNEL below Santa Fe Dam.
STATION NO. F280-R**

Season	Daily CFS			Total Runoff (Acre-feet)	Peak Flow	
	Maximum	Minimum	Mean		Date	CFS
1976-77	24	0	2	1,439	Aug 17	52
1977-78	*	*	56.2	40,699	Apr 21	432
1978-79	148	0	16.7	12,113	May 01	195
1979-80	388	0	48.3	34,730	Mar 02	440
1980-81	370	0	19.8	14,360	Nov 20	384
1981-82	268	0	18	13,050	Jun 17	284
1982-83	365	0	49.9	36,043	Jul 13	400
1983-84	382	0	23.1	16,768	Oct 14	453
1984-85	32	0	0.4	278	Dec 19	57
1985-86	378	0	40.2	29,110	Feb 27	391
1986-87	5	0	1.9	115	Nov 18	7
1987-88	424	0	11.5	8,362	Jun 09	429
1988-89	7	0	0.4	302	May 11	11
1989-90	0	0	0	0		0
1990-91	547	0	23.5	16,782	Jul 31	566
1991-92	428	0	50.2	36,405	Feb 04	450
1992-93	193	0	42	30,370	Aug 09	215
1993-94	72	0	2.1	1,511	Jul 29	129
1994-95	410	0	23.5	17,050	Dec 04	414
1995-96	385	0	35.8	25,988	Oct 05	397
1996-97	393	0	19.6	14,220	Jul 22	407
1997-98	452	0	23.5	17,010	May 19	467
1998-99	113	0	2.2	1,570	Feb 10	225
1999-00	0	0	0	0		0
2000-01	16	0	0.7	470	Jan 08	179
2001-02	17	0	0.3	217	Jan 16	22
2002-03	208	0	2.2	1,562	Aug 12	326
2003-04	52	0	0.8	605	Oct 09	56
2004-05	520	0	46	33,300	Mar 09	540
2005-06	258	0	9.5	6,860	Apr 27	280
2006-07						
2007-08	251	0	7.5	5,447	Sep 11	448
2008-09	328	0	8.3	6,030	Oct 22	447

M Data missing

* Record incomplete

E Estimate

N.D. Not determined

** Record not computed

+ Less than 0.05 acre feet or less than 0.05 cfs, but greater than 0

RUNOFF – STREAM GAGING STATION PEAK FLOW

**SANTA FE DIVERSION CHANNEL below Santa Fe Dam.
STATION NO. F280-R**

Season	Daily CFS			Total Runoff (Acre-feet)	Peak Flow	
	Maximum	Minimum	Mean		Date	CFS
2009-10	88	0	1.98	1,430	Sep 20	119
2010-11	326	0	41.2	29,860	Apr 13	382
2011-12	312	0	11	7,950	Nov 29	427
2012-13	3,535	0	0.25	184	Nov 03	42
2013-14	0	0	0	0	May 13	0
2014-15	0	0	0	0	Feb 24	0

M Data missing

* Record incomplete

E Estimate

N.D. Not determined

** Record not computed

+ Less than 0.05 acre feet or less than 0.05 cfs, but greater than 0

RUNOFF – STREAM GAGING STATION PEAK FLOW

**SANTIAGO CANYON CREEK above Little Rock Creek.
STATION NO. F125-R**

Season	Daily CFS			Total Runoff (Acre-feet)	Peak Flow	
	Maximum	Minimum	Mean		Date	CFS
1953-54	24	0	0.9	631	Jan 25	44
1954-55	13	0	0.8	602	Feb 17	16
1955-56	41	0	0.6	406	Jan 26	87
1956-57	7	0	0.3	199	Jan 13	15
1957-58	58	0	3.2	2,280	Apr 03	107
1958-59	10	0	0.5	386	Feb 16	21
1959-60	1	0	0.1	75	Feb 02	2
1960-61	+	0	+	+	Aug 05	1
1961-62	118	0	1.3	945	Feb 11	199
1962-63	1	0	+	19	Apr 21	1
1963-64	0	0	+	10	Apr 02	1
1964-65	4	0	0.1	87	Apr 20	4
1965-66	78	0	1.3	926	Dec 29	269
1966-67	38	0	1.4	982	Dec 06	66
1967-68	10	0	0.5	380	Nov 21	17
1968-69	345	0	5.8	4,170	Jan 25	1,140
1969-70	14	0	0.6	455	Mar 01	21
1970-71	7	0	0.4	290	Nov 29	22
1971-72	3	0	0.1	75	Dec 24	5
1972-73	72	0	0.9	640	Feb 11	175
1973-74	4	0	0.2	144	Jan 17	6
1974-75	4	0	0.2	121	Mar 06	6
1975-76	14	0	0.1	55	Sep 24	1,060
1976-77	6	0	0.1	83	May 09	9
1977-78	*	*	*	*	Feb 09	*
1978-79	23	0	1.4	986	Mar 28	303
1979-80	67	0	3.1	2,227	Feb 16	193
1980-81	3	0	0.2	158		N.D.
1981-82	30	0	0.8	602		N.D.
1982-83	152	0	5.6	4,022	Mar 01	280
1983-84	11	0	1	711	Dec 25	26
1984-85	40	0	0.5	347	Dec 19	103
1985-86	14	0	0.5	337	Jan 30	24

M Data missing

* Record incomplete

E Estimate

N.D. Not determined

** Record not computed

+ Less than 0.05 acre feet or less than 0.05 cfs, but greater than 0

RUNOFF – STREAM GAGING STATION PEAK FLOW

**SANTIAGO CANYON CREEK above Little Rock Creek.
STATION NO. F125-R**

Season	Daily CFS			Total Runoff (Acre-feet)	Peak Flow	
	Maximum	Minimum	Mean		Date	CFS
1986-87	1	0	+	11	Mar 07	1
1987-88	17	0	3.3	204		N.D.
1988-89	11	0	2.9	165	Feb 09	86
1989-90	0	0	0	0		0
1990-91	20	0	0.2	109		N.D.
1991-92	51	0	0.9	627	Feb 12	97
1992-93	177	0	5.9	4,266	Feb 19	235
1993-94	2	0	0.3	248	Feb 14	2
1994-95	77	0	1.9	1,379	Mar 11	90
1995-96	56	0	0.5	335	Mar 05	75
1996-97	12	0	0.2	120	Jan 26	19
1997-98	121	0	4.2	3,050	Feb 23	317
1998-99	3	0	0.3	246	Jul 13	5
1999-00	6	0	0.1	98	Apr 18	7
2000-01	23	0	0.6	454	Mar 06	37
2001-02	N.D.					
2002-03	0	0	0.3	0	Feb 12	52
2003-04	6	0	0.1	32	Feb 26	21
2004-05	236	0	6.2	4,440	Feb 21	470
2005-06	64	0	2.1	1,420	Feb 28	95
2006-07						
2007-08	94	0	2.7	1,961	Feb 14	109
2008-09	6	0	0.1	87	Nov 27	32
2009-10	62	0	2.7	1,990	Feb 06	110
2010-11	99	0	30.1	21,780	Jan 29	110
2011-12	7	0	0.51	367	Feb 17	12
2012-13	1	0	0.094	68	Mar 08	1
2013-14	22.8	0	0.2	142	Mar 01	37.6
2014-15	0	0	0	0	Oct 01	0

M Data missing

* Record incomplete

E Estimate

N.D. Not determined

** Record not computed

+ Less than 0.05 acre feet or less than 0.05 cfs, but greater than 0

RUNOFF – STREAM GAGING STATION PEAK FLOW

**SAWPIT CREEK below Sawpit Dam.
STATION NO. F278-R**

Season	Daily CFS			Total Runoff (Acre-feet)	Peak Flow	
	Maximum	Minimum	Mean		Date	CFS
1941-42	1	0	0.1	30	Mar 13	3
1942-43	186	0	4	2,860	Jan 23	284
1943-44	50	0	1	667	Feb 22	67
1944-45	N.D.					
1945-46	21	0	0.2	169	Dec 23	36
1946-47	18	0	0.5	329	Dec 26	26
1947-48	N.D.					
1948-49	N.D.					
1949-50	N.D.					
1950-51	N.D.					
1951-52	N.D.					
1952-53	N.D.					
1953-54	N.D.					
1954-55	N.D.					
1955-56	N.D.					
1956-57	N.D.					
1957-58	N.D.					
1958-59	N.D.					
1959-60	N.D.					
1960-61	N.D.					
1961-62	N.D.					
1962-63	N.D.					
1963-64	N.D.					
1964-65	N.D.					
1965-66	N.D.					
1966-67	N.D.					
1967-68	N.D.					
1968-69	N.D.					
1969-70	N.D.					
1970-71	N.D.					
1971-72	N.D.					
1972-73	N.D.					
1973-74	N.D.					

M Data missing

* Record incomplete

E Estimate

N.D. Not determined

** Record not computed

+ Less than 0.05 acre feet or less than 0.05 cfs, but greater than 0

RUNOFF – STREAM GAGING STATION PEAK FLOW

**SAWPIT CREEK below Sawpit Dam.
STATION NO. F278-R**

Season	Daily CFS			Total Runoff (Acre-feet)	Peak Flow	
	Maximum	Minimum	Mean		Date	CFS
1974-75	6	0.5	1.3	921	Oct 04	9
1975-76	6	0.2	0.9	646	Sep 11	20
1976-77	6	0.2	0.8	603	Oct 22	36
1977-78	88	0.2	6.5	4,717	Mar 04	132
1978-79	10	0	2.8	1,985	Oct 02	55
1979-80	110	0	4.8	3,485	Feb 06	216
1980-81	5	0	1.4	1,046	Mar 19	9
1981-82	39	0.4	1.8	1,307	Apr 26	72
1982-83	89	0	6.2	4,486	Mar 01	269
1983-84	15	0	1.8	1,269	May 07	63
1984-85	7	0.5	1.3	936	Dec 19	14
1985-86	10	0	1.7	1,204	Mar 08	13
1986-87	N.D.					
1987-88	4	0.4	1.7	1,193		
1988-89	10	0.2	1	740		
1989-90	6	0	0.8	545		
1990-91	34	0	1.5	1,089		
1991-92	44	0.4	2.6	1,910	Feb 11	59
1992-93	77	1.1	8.8	6,393	Feb 08	93
1993-94	4	1.4	2.1	1,555	Jun 22	30
1994-95	80	1.5	4.9	3,552	Mar 05	85
1995-96	32	0.1	3.1	2,247	Feb 22	35
1996-97	11	1.5	2.7	1,952	Jan 26	14
1997-98	89	1.7	4.2	3,039	Feb 24	143
1998-99	3	0.7	2.2	1,580	Jun 02	50
1999-00*	4	0.7	1.7	1,262	May 03	6
2000-01	8.1E	0.45E	1.47E	1060E	Feb 13	15
2001-02	2	0.1	1	695	Jan 27	8
2002-03	10	0.3	1.4	983	Feb 12	28
2003-04	13	0.3	1	360	Feb 26	45
2004-05	184	0.1	5.6	4,030	Jan 09	260
2005-06	9	1.2	2.1	1,510	Jan 02	22
2006-07	2	0.6	1.2	881	Feb 27	3

M Data missing

* Record incomplete

E Estimate

N.D. Not determined

** Record not computed

+ Less than 0.05 acre feet or less than 0.05 cfs, but greater than 0

RUNOFF – STREAM GAGING STATION PEAK FLOW

**SAWPIT CREEK below Sawpit Dam.
STATION NO. F278-R**

Season	Daily CFS			Total Runoff (Acre-feet)	Peak Flow	
	Maximum	Minimum	Mean		Date	CFS
2007-08	21	0.7	1.6	1,180	Jan 05	161
2008-09	4	0.6	1.1	827	Nov 25	7
2009-10	4	0.67	1.23	890	Dec 12	11
2010-11	41	0.68	2.08	1,500	Dec 20	226
2011-12	4	0.91	1.61	1,170	Apr 04	11
2012-13	4	0.46	1.79	1,290	Dec 08	8
2013-14	6.1	0.27	1.2	870	Feb 28	10
2014-15	3.0	0.35	0.85	616	May 14	5

M Data missing

* Record incomplete

E Estimate

N.D. Not determined

** Record not computed

+ Less than 0.05 acre feet or less than 0.05 cfs, but greater than 0

RUNOFF – STREAM GAGING STATION PEAK FLOW

SAWPIT WASH below Live Oak Avenue.
STATION NO. F194B-R

Season	Daily CFS			Total Runoff (Acre-feet)	Peak Flow	
	Maximum	Minimum	Mean		Date	CFS
1960-61	50	+	*	263*	Jan 26	420
1961-62	573	+	16.6	11,980	Feb 11	1,300
1962-63	137	+	1.6	1,180	Feb 09	690
1963-64	83	+	1.6	1,190	Jan 22	682
1964-65	95	+	2.1	1,500	Apr 09	1,290
1965-66	243	+	7.3	9,240	Dec 29	1,470
1966-67	298	+	22	16,020	Dec 03	1,120
1967-68	130	+	2.1	1,520	Nov 19	1,870
1968-69	1,270	+	53.7	38,870	Jan 25	3,960
1969-70	773	0	6.7	4,830	Feb 28	2,800
1970-71	196	+	5.8	4,190	Nov 29	1,350
1971-72	142	0.1	2	1,450	Dec 24	519
1972-73	381	0	16.8	12,130	Feb 27	2,860
1973-74	265	0.1	9	6,490	Jan 07	652
1974-75	180	+	2.8	2,010	Dec 04	2,140
1975-76	101	0.1	1.8	1,310	Sep 11	1,790
1976-77	118	0.1	3.8	2,732	Oct 23	1,090
1977-78	*	*	*	*	Feb 10	*
1978-79	160	0.2	20.3	14,687	Feb 21	1,280
1979-80	886	0.2	50.2	35,952	Feb 16	3,940
1980-81	376	0	23.1	16,742	Jan 29	900
1981-82	257	0.1	18.1	13,029	Mar 17	1,560
1982-83	530	0.1	56.4	40,867	Mar 01	2,890
1983-84	294	0	20.4	14,767	Oct 01	1,210
1984-85	122	0	2.6	1,873	Dec 19	801
1985-86	*	*	*	*		*
1986-87	99	0.1	1.2	857	Oct 02	1,070
1987-88	385	0	12.9	9,344	Dec 04	1,630
1988-89	76	0	1.6	1,167	Dec 16	555
1989-90	147	0	1.3	909	Jan 13	707
1990-91	331	0	17.3	12,646	Aug 08	375
1991-92	325	0	36.8	26,730	Feb 11	1,710
1992-93	352	0	42.4	30,690	Jan 14	4,160

M Data missing

* Record incomplete

E Estimate

N.D. Not determined

** Record not computed

+ Less than 0.05 acre feet or less than 0.05 cfs, but greater than 0

RUNOFF – STREAM GAGING STATION PEAK FLOW

SAWPIT WASH below Live Oak Avenue.
STATION NO. F194B-R

Season	Daily CFS			Total Runoff (Acre-feet)	Peak Flow	
	Maximum	Minimum	Mean		Date	CFS
1993-94	72	0	3.7	2,671	Mar 19	1,160
1994-95	495	0.1	29.2	21,160	Jan 10	1,940
1995-96	530	0.2	44.1	32,020	Jan 31	3,580
1996-97	393	0.1	22.6	16,350	Jan 26	1,130
1997-98	452	0.2	32.6	23,570	Feb 06	2,960
1998-99	142	0.2	3.5	2,500	Jan 26	543
1999-00	127	0.1	4.1	2,960	Apr 17	1,110
2000-01	187	0.1	3.4	2,440	Jan 02	2,200
2001-02	122	0	1	710	Nov 24	2,087
2002-03	293	0	6.1	4,382	Mar 15	1,730
2003-04	236	0	2.9	2,118	Feb 26	1,810
2004-05	478	0	44.3	32,000	Feb 19	3,930
2005-06	221	0	12.5	9,040	Apr 14	2,507
2006-07	71	0.1	1.4	1,014	Feb 11	900
2007-08	321	0.1	11.1	8,031	Jan 04	3,980
2008-09	327	+	10.1	7,300	Feb 05	2,320
2009-10	135	0.1	5.4	3,890	Feb 06	1,900
2010-11	344	0.1	50.4	36,470	Dec 22	3,770
2011-12	337	0.06	13.5	9,770	Mar 17	1,720
2012-13	33	0.03	0.81	585	Mar 08	502
2013-14	141	0.04	0.93	674	Feb 28	1,360
2014-15	114	0.01	1.51	1,090	Dec 12	2,410

M Data missing

* Record incomplete

E Estimate

N.D. Not determined

** Record not computed

+ Less than 0.05 acre feet or less than 0.05 cfs, but greater than 0

RUNOFF – STREAM GAGING STATION PEAK FLOW

THOMPSON CREEK below Thompson Creek Dam.
STATION NO. F32-R

Season	Daily CFS			Total Runoff (Acre-feet)	Peak Flow	
	Maximum	Minimum	Mean		Date	CFS
1945-46	N.D.					
1946-47	N.D.					
1947-48	N.D.					
1948-49	N.D.					
1949-50	N.D.					
1950-51	N.D.					
1951-52	5	0	0	33	Mar 17	5
1952-53	N.D.					
1953-54	N.D.					
1954-55	N.D.					
1955-56	N.D.					
1956-57	N.D.					
1957-58	7	0	0.3	219	Apr 05	9
1958-59	N.D.					
1959-60	N.D.					
1960-61	N.D.					
1961-62	N.D.					
1962-63	N.D.					
1963-64	N.D.					
1964-65	N.D.					
1965-66	N.D.					
1966-67	23	0	0.4	305	Dec 06	130
1967-68	N.D.					
1968-69	N.D.					
1969-70	N.D.					
1970-71	N.D.					
1971-72	N.D.					
1972-73	N.D.					
1973-74	N.D.					
1974-75	N.D.					
1975-76	N.D.					
1976-77	N.D.					
1977-78	136	0	1.4	1,038	Mar 02	170

M Data missing

* Record incomplete

E Estimate

N.D. Not determined

** Record not computed

+ Less than 0.05 acre feet or less than 0.05 cfs, but greater than 0

RUNOFF – STREAM GAGING STATION PEAK FLOW

**THOMPSON CREEK below Thompson Creek Dam.
STATION NO. F32-R**

Season	Daily CFS			Total Runoff (Acre-feet)	Peak Flow	
	Maximum	Minimum	Mean		Date	CFS
1978-79	4	0	0.1	46	May 04	8
1979-80	219	0	2.2	1,592	Feb 17	333
1980-81	N.D.					
1981-82	4	0	0	18	Feb 18	8
1982-83	77	0	0.8	581	Mar 02	83
1983-84	3	0	0	11	Dec 28	12
1984-85	N.D.					
1985-86	10	0	0.1	59	Mar 16	17
1986-87	N.D.					
1987-88	1	0	0	2	Jan 17	1
1988-89	0	0	0	2	Feb 04	1
1989-90	37	0	0	0	Apr 04	57
1990-91	2	0	0	34	Mar 02	3
1991-92	2	0	0.1	67	Feb 10	6
1992-93	55	0	1.9	1,323	Feb 08	113
1993-94	4	0	0	8	Nov 01	7
1994-95	26	0	0.4	299	Mar 06	63
1995-96	33	0	0.6	456	Feb 21	35
1996-97	11	0	0.1	50	Jan 29	55
1997-98	74	0	0.7	522	Feb 23	158
1998-99	0	0	0	14	Jul 14	0
1999-00	0	0	0	19	Apr 18	1
2000-01	1	0	0	4	Jan 16	10
2001-02	1	0	0	24	Nov 20	1
2002-03	14	0	1	71	Mar 16	18
2003-04	38	0	0.1	268	Mar 16	13
2004-05	84	0	2.3	1,640	Feb 21	140
2005-06	0	0	0	0	Feb 28	0
2006-07	N.D.					
2007-08	8	0	0.1	84	Jan 30	16
2008-09	0	0	+	3	Feb 18	1
2009-10	0	0	0.1	9	Jan 18	1
2010-11	40	0	0.11	79	Dec 22	75

M Data missing

* Record incomplete

E Estimate

N.D. Not determined

** Record not computed

+ Less than 0.05 acre feet or less than 0.05 cfs, but greater than 0

RUNOFF – STREAM GAGING STATION PEAK FLOW

THOMPSON CREEK below Thompson Creek Dam.
STATION NO. F32-R

Season	Daily CFS			Total Runoff (Acre-feet)	Peak Flow	
	Maximum	Minimum	Mean		Date	CFS
2011-12	0	0	0	0	Mar 17	0
2012-13	0	0	0	0	N.D	0
2013-14	0	0	0	0	N.D	0
2014-15	0	0	0.005	3	Dec 03	0

M Data missing

* Record incomplete

E Estimate

N.D. Not determined

** Record not computed

+ Less than 0.05 acre feet or less than 0.05 cfs, but greater than 0

RUNOFF – STREAM GAGING STATION PEAK FLOW

**TOPANGA CREEK above mouth of canyon.
STATION NO. F54C-R**

Season	Daily CFS			Total Runoff (Acre-feet)	Peak Flow	
	Maximum	Minimum	Mean		Date	CFS
1930-31	186	+	1	705	Feb 14	386
1931-32	409	+	4.9	3,590	Feb 08	1,250
1932-33	542	+	3.1	2,240	Jan 19	1,430
1933-34	1,590	0	8.9	6,420	Dec 31	4,510
1934-35	130	+	1.9	1,360	Jan 05	1,200
1935-36	77	+	2	1,490	Feb 22	528
1936-37	413	+	9.1	6,620	Mar 15	1,130
1937-38	3,270	+	21.2	15,310	Mar 02	9,300E
1938-39	NO RECORD					
1939-40	183	+	2.9	2,080	Feb 01	1,280
1940-41	1,100.0E	+	26.2	18,940	Feb 20	8,700E
1941-42	47	+	0.8	540	Dec 28	385
1942-43	1,100.0E	+	12	8,720	Jan 22	2,200
1943-44	1,100.0E	0.1	9.6	6,970	Feb 22	5,070
1944-45	176	0.1	1.5	1,090	Feb 02	964
1945-46	182	+	1.9	1,390	Dec 23	905
1946-47	86	+	1.4	994	Nov 20	567
1947-48	23	0	0.2	168	Mar 24	276
1948-49	5	+	0.1	99	Dec 26	63
1949-50	35	+	0.5	379	Dec 18	275
1950-51	2	+	0.1	74	Jan 11	21
1951-52	1,990	0	23.3	16,900	Jan 15	6,050
1952-53	52	+	1	725	Dec 01	702
1953-54	396	0	2.5	1,820	Feb 13	2,090
1954-55	33	+	0.5	354	Jan 18	151
1955-56	337	+	1.4	1,030	Jan 26	1,540
1956-57	69	+	0.5	374	Feb 23	655
1957-58	599	+	10.4	7,460	Apr 03	3,950
1958-59	141	+	1.1	785	Jan 06	1,510
1959-60	76	+	0.6	422	Apr 27	539
1960-61	8	+	0.1	58	Jan 26	28
1961-62	1,150	+	10.7	7,720	Feb 10	2,790
1962-63	66	+	0.6	454	Feb 09	569

M Data missing

* Record incomplete

E Estimate

N.D. Not determined

** Record not computed

+ Less than 0.05 acre feet or less than 0.05 cfs, but greater than 0

RUNOFF – STREAM GAGING STATION PEAK FLOW

**TOPANGA CREEK above mouth of canyon.
STATION NO. F54C-R**

Season	Daily CFS			Total Runoff (Acre-feet)	Peak Flow	
	Maximum	Minimum	Mean		Date	CFS
1963-64	17	+	0.2	178	Jan 21	196
1964-65	148	+	1.2	886	Apr 09	716
1965-66	1,120	+	10	7,270	Dec 29	3,500
1966-67	569	0.1	7	5,070	Jan 24	2,280
1967-68	186	0.1	2.2	1,570	Mar 08	567
1968-69	4,920	0.1	40.6	29,400	Jan 25	12,200
1969-70	84	0	1.2	902	Mar 04	844
1970-71	720	+	6.3	4,560	Jan 29	3,020
1971-72	110	0.2	1.1	809	Dec 27	588
1972-73	1,140	0.1	8.6	6,250	Feb 11	3,840
1973-74	1,060	0.1	5.7	4,110	Jan 07	2,060
1974-75	286	0.1	3	2,200	Mar 06	1,670
1975-76	24	+	0.3	214	Feb 09	72
1976-77	30	+	0.6	405	Jan 03	219
1977-78	2,676	0.1	32.4	23,480	Mar 04	10,127
1978-79	425	0.2	7.2*	5,180	Mar 27	2,490
1979-80	3,919	0.2	33.2	23,236	Feb 16	20,200
1980-81	90	0.1	1.8	1,279	Mar 02	219
1981-82	144	0.2	1.5	1,066	Mar 17	650
1982-83	2,274	0.2	277	19,241	Jan 27	10,200
1983-84	203	0.2	2.2	1,445	Dec 25	2,612
1984-85	26	0.2	1.3	943	Dec 26	56
1985-86	823	0.2	10	7,211	Feb 14	5,135
1986-87	*	*	*	*		*
1987-88	*	*	*	*		*
1988-89	10	0.1	0.4	283	Dec 21	32
1989-90	*	*	*	*		*
1990-91	Discont	Feb-90	Restored	10/97.		
1996-97	80	0.5	3	2,140	Dec 09	229
1997-98	494	0.7	24.4	17,640	Feb 23	2,470
1998-99	19	0.5	1.2	839	Apr 11	93
1999-00	133	0.3	2.8	2,030	Feb 23	1,050
2000-01	257	0.5	7.6	5,520	Jan 11	2,820

M Data missing

* Record incomplete

E Estimate

N.D. Not determined

** Record not computed

+ Less than 0.05 acre feet or less than 0.05 cfs, but greater than 0

RUNOFF – STREAM GAGING STATION PEAK FLOW

**TOPANGA CREEK above mouth of canyon.
STATION NO. F54C-R**

Season	Daily CFS			Total Runoff (Acre-feet)	Peak Flow	
	Maximum	Minimum	Mean		Date	CFS
2001-02	35	0	1.4	1,049	Nov 24	195
2002-03	552	0.2	5.4	3,918	Feb 12	1,660
2003-04	649	0.2	4.4	3,184	Feb 26	3,780
2004-05	2,000	1	54.9	39,700	Dec 28	3,980
2005-06	86	1.3	4.1	2,990	Jan 02	481
2006-07	5	0.4	1.3	937	Jan 28	8
2007-08	8,810	0	149.4	108,444	Jan 05	8,813
2008-09	101	0.2	1.2	880	Feb 16	1,040
2009-10	344	0	3.2	2,320	Feb 06	3,370
2010-11	512	0.38	5.04	3,650	Mar 20	6,240
2011-12	37	0.31	0.87	628	Mar 25	283
2012-13	5	0	0.76	552	Dec 24	10
2013-14	87.2	0.08	0.63	453	Feb 28	316
2014-15	37.4	0	0.98	710	Dec 12	167

M Data missing

* Record incomplete

E Estimate

N.D. Not determined

** Record not computed

+ Less than 0.05 acre feet or less than 0.05 cfs, but greater than 0

RUNOFF – STREAM GAGING STATION PEAK FLOW

**VERDUGO WASH at Estelle Avenue.
STATION NO. F252-R**

Season	Daily CFS			Total Runoff (Acre-feet)	Peak Flow	
	Maximum	Minimum	Mean		Date	CFS
1928-29	15	0	*	140*	Apr 04	56*
1929-30	14	0	0.4	274	May 03	80
1930-31	8	+	0.2	145	Apr 26	46
1931-32	39	0.1	1	713	Feb 09	145
1932-33	42	0.1	0.4	295	Jan 19	391
1933-34	NO RECORD					
1934-35	85*	0	*	620	Jan 05	1,020*
1935-36	33	0	0.6	463	Mar 30	1,100*
1936-37	*	0	*	1,560	Dec 27	768
1937-38	1,500	0	7.5	5,450	Mar 02	4,400E
1938-39	78	0	2	1,420	Jan 05	520
1939-40	60	+	2	1,430	Jan 08	533
1940-41	357	+	10.2	7,370	Feb 19	1,120
1941-42	81	0.8	3	2,160	Dec 10	440
1942-43	1,020	0.3	12	8,690	Jan 23	3,570
1943-44	998	0.2	7	5,040	Feb 22	3,160
1944-45	181	0.6	2.8	2,010	Feb 02	1,520
1945-46	135	0.3	2.7	1,930	Dec 22	816
1946-47	234	0	2.7	1,940	Dec 25	1,860
1947-48	41	0	0.5	382	Mar 24	573
1948-49	35	0	0.6	433	Dec 16	202
1949-50	69	0	0.9	638	Feb 06	467
1950-51	41	0	0.5	383	Jan 11	960
1951-52	422	0	7.8	5,630	Jan 16	2,920
1952-53	100	0	1.3	968	Nov 15	1,520
1953-54	227	0	2.7	1,920	Feb 13	1,300
1954-55	134	0	2	1,480	Jan 18	784
1955-56	550	0	2.5	1,840	Jan 26	1,940
1956-57	184	0	1.9	1,400	Feb 23	2,960
1957-58	236	0	5.2	3,770	Feb 19	1,700
1958-59	232	0	2	1,440	Feb 16	2,080
1959-60	56	0	1.2	862	Jan 11	533

M Data missing

* Record incomplete

E Estimate

N.D. Not determined

** Record not computed

+ Less than 0.05 acre feet or less than 0.05 cfs, but greater than 0

RUNOFF – STREAM GAGING STATION PEAK FLOW

**VERDUGO WASH at Estelle Avenue.
STATION NO. F252-R**

Season	Daily CFS			Total Runoff (Acre-feet)	Peak Flow	
	Maximum	Minimum	Mean		Date	CFS
1960-61	98	+	0.9	667	Nov 05	676
1961-62	592	0	6.8	4,830	Feb 12	1,880
1962-63	370	+	2	1,460	Feb 09	2,180
1963-64	192	0	2.1	1,510	Jan 21	1,640
1964-65	249	+	3.8	2,780	Apr 08	1,480
1965-66	1,030	0.1	12.2	8,830	Dec 29	3,480
1966-67	422	0.5	10.4	7,530	Jan 22	3,230
1967-68	606	0.2	9.3	6,730	Mar 08	3,460
1968-69	1,850	1.8	36.1	26,120	Jan 25	5,050
1969-70	261	2	8.4	6,090	Feb 28	2,500
1970-71	931	1.8	10.6	7,690	Nov 29	5,330
1971-72	476	1.2	14.8	4,570	Dec 24	1,960
1972-73	897	1	12.8	9,280	Jan 18	4,010
1973-74	671	1.8	10.2	7,380	Jan 07	2,390
1974-75	373	0.7	7.7	5,590	Dec 04	3,390
1975-76	180	0.5	6.4	4,560	Mar 01	1,190
1976-77	210	0.3	6	4,318	Jan 03	2,100
1977-78	1,700	+	34.2	24,739	Feb 10	9,820
1978-79	*	*	*	*	Mar 27	*
1979-80	440	1.2	18.1	13,000	Feb 16	6,420
1980-81	266	1.5	12	8,706	Jan 29	2,870
1981-82	333	1	12.5	9,083	Apr 01	1,960
1982-83	1,260	2	37	26,750	Mar 01	6,714
1983-84	NO RECORD					
1984-85	279	1	9.2	6,686	Dec 19	2,430
1985-86	437	1.2	12.1	8,737	Mar 08	1,620
1986-87	158	1.5	5	3,635		N.D.
1987-88	688	2.3	19.3	14,042	Feb 01	4,150
1988-89	301	0.3	9.1	6,262	Dec 16	1,700
1989-90	474	+	5.7	4,120	Feb 17	1,820
1990-91	544	0.2	11.1	8,017		N.D.
1991-92	636	0	20.1	14,621	Feb 10	4,110

M Data missing

* Record incomplete

E Estimate

N.D. Not determined

** Record not computed

+ Less than 0.05 acre feet or less than 0.05 cfs, but greater than 0

RUNOFF – STREAM GAGING STATION PEAK FLOW

**VERDUGO WASH at Estelle Avenue.
STATION NO. F252-R**

Season	Daily CFS			Total Runoff (Acre-feet)	Peak Flow	
	Maximum	Minimum	Mean		Date	CFS
1992-93	733	1.7	32.5	23,520	Jun 05	4,320
1993-94	265	0	10.4	7,543	Nov 30	2,220
1994-95	1,710	1	46.5	33,700	Jan 10	4,460
1995-96	1,260	0.8	18.6	13,520	Feb 21	3,460
1996-97	1,140	1.9	23.3	16,860	Dec 22	3,010
1997-98	966	3.9	22.3	16,150	Feb 07	5,550
1998-99	117	3.6	10	7,250	Nov 28	1,390
1999-00	289	2.9	11.7	8,470	Feb 16	2,700
2000-01	258	3.1	10.9	7,870	Jan 10	1,040
2001-02	265	0.3	10.5	7,545	Nov 24	4,328
2002-03	524	0.1	11.5	8,341	Mar 15	2,960
2003-04	0	0	7.4	0	Feb 26	2,840
2004-05	1,350	5.4	51.2	37,100	Feb 21	4,940
2005-06	547	8.1	19.5	14,120	Jan 02	3,902
2006-07	139	5.4	11	7,943	Feb 27	1,001
2007-08	483	0.9	13.7	9,916	Jan 04	5,700
2008-09	252	+	6.6	4,760	Feb 05	5,080
2009-10	1,630	0	19.7	14,300	Feb 06	8,030
2010-11	661	0.2	28.2	20,420	Dec 20	2,300
2011-12	239	0.61	6.52	4,730	Mar 17	2,320
2012-13	54	0.63	3.53	2,550	Oct 11	1,650
2013-14	370	0.38	4.16	3,010	Feb 28	2,190
2014-15	352	0	5.63	4,070	Jul 19	1,920

M Data missing

* Record incomplete

E Estimate

N.D. Not determined

** Record not computed

+ Less than 0.05 acre feet or less than 0.05 cfs, but greater than 0

RUNOFF – STREAM GAGING STATION PEAK FLOW

**WALNUT CREEK above Puente Avenue.
STATION NO. F304-R**

Season	Daily CFS			Total Runoff (Acre-feet)	Peak Flow	
	Maximum	Minimum	Mean		Date	CFS
1952-53	47	0	0.4	292	Dec 01	713
1953-54	297	0	34.9	25,290	Feb 13	1,500
1954-55	337	0	29.9	21,640	Jan 18	732
1955-56	1,120	0	68.5	49,730	Jan 26	3,450
1956-57	361	0	71.2	51,530	Feb 28	2,200
1957-58	494	0	11.7	8,490	Apr 07	2,510
1958-59	279	0	2.2	1,610	Jan 06	2,480
1959-60	163	0	1.8	1,300	Jan 12	1,160
1960-61	272	0	12.4	9,010	Jan 26	411
1961-62	431	*	*	4,800	Feb 11	2,090
1962-63	267	+	4.6	3,360	Mar 16	1,410
1963-64	232	+	3.9	2,860	Jan 22	1,280
1964-65	435	0.2	16.1	11,640	Apr 09	3,250
1965-66	646	0.2	11	7,920	Dec 29	2,060
1966-67	685	0.1	20.8	15,060	Jan 24	3,360
1967-68	647	+	23.3	16,880	Mar 08	3,390
1968-69	1,830	+	68.4	49,490	Feb 25	4,960
1969-70	278	+	4.5	3,250	Mar 01	2,210
1970-71	384	0	9.4	6,810	Dec 21	1,630
1971-72	546	0	4.1	3,070	Dec 24	2,650
1972-73	591	0	9.5	6,920	Jan 16	2,730
1973-74	749	0.1	9.2	6,670	Jan 07	2,020
1974-75	551	+	7.1	5,170	Dec 04	4,200
1975-76	255	+	3.9	2,800	Sep 10	1,200
1976-77	295	0	5.4	3,939	May 09	1,920
1977-78	1,970	0	65	47,085	Mar 04	7,820
1978-79	714	0	17.4	12,619	Mar 27	3,020
1979-80	2,490	0	54.5	38,432	Feb 16	6,280
1980-81	468	0	4.7	3,406	Mar 01	1,840
1981-82	724	0	11.1	8,030	Mar 14	2,800
1982-83	1,570	0	45.2	32,750	Feb 27	5,850
1983-84	424	0	5.7	4,138	Oct 01	2,340
1984-85	276	0	8.2	5,917	Nov 13	2,230

M Data missing

* Record incomplete

E Estimate

N.D. Not determined

** Record not computed

+ Less than 0.05 acre feet or less than 0.05 cfs, but greater than 0

RUNOFF – STREAM GAGING STATION PEAK FLOW

**WALNUT CREEK above Puente Avenue.
STATION NO. F304-R**

Season	Daily CFS			Total Runoff (Acre-feet)	Peak Flow	
	Maximum	Minimum	Mean		Date	CFS
1985-86	532	0	13.2	9,537	Mar 08	3,580
1986-87	693	0	5.4	3,976	Oct 02	2,653
1987-88	454	0	7.3	5,355	Oct 22	3,288
1988-89	157	0	2.3	1,626	Mar 25	869
1989-90	44	0	2.9	2,066	May 28	2,006
1990-91	724	+	11.1	7,924	Mar 26	3,386
1991-92	1,090	0	28.1	20,383	Feb 12	6,400
1992-93	1,470	0	68.9	49,850	Jan 07	5,700
1993-94	249	0	6.6	4,807	Apr 26	2,690
1994-95	900	0	24.8	17,970	Jan 10	5,040
1995-96	1,200	0	17	12,338	Jan 31	5,400
1996-97	453	+	12.9	9,360	Jan 26	2,810
1997-98	1,310	+	39	28,250	Feb 07	5,670
1998-99	159	0	6.3	4,590	Nov 28	1,400
1999-00	381	0	11	8,010	Feb 23	3,130
2000-01	620	0	12.1	8,760	Jan 11	2,430
2001-02	320	0	2.8	2,001	Nov 24	5,196
2002-03	810	0.1	15	10,841	Mar 15	3,990
2003-04	568	0.2	8.3	6,007	Feb 25	2,350
2004-05	1,370	0.2	58.9	42,600	Oct 20	4,720
2005-06	391	1.1	19.4	14,070	Jan 02	2,867
2006-07	198	0	13.7	9,924	Apr 20	1,921
2007-08	536	0	15.3	11,071	Jan 05	3,964
2008-09	418	0	10.4	7,530	Feb 05	4,580
2009-10	797	+	19	13,740	Jan 20	4,160
2010-11	1,550	+	23.7	17,190	Dec 22	4,600
2011-12	226	0	3.63	2,630	Oct 05	1,630
2012-13	115	0.01	2.73	1,970	Mar 08	926
2013-14	432	0	2.63	1,900	Feb 28	2,430
2014-15	234	0.02	3.88	2,810	Jul 19	3,030

M Data missing

* Record incomplete

E Estimate

N.D. Not determined

** Record not computed

+ Less than 0.05 acre feet or less than 0.05 cfs, but greater than 0

RUNOFF – STREAM GAGING STATION PEAK FLOW

**WALNUT CREEK below Puddingstone Dam.
STATION NO. F40-R**

Season	Daily CFS			Total Runoff (Acre-feet)	Peak Flow	
	Maximum	Minimum	Mean		Date	CFS
1932-33	1	0	0.1	17	Jan 29	33
1933-34	3	0	0.3	40	Sep 17	+
1934-35	1	0	0.1	44	Oct 17	4
1935-36	1	0	0.1	36	Feb 12	13
1936-37	6	0	0.4	197	Feb 06	18
1937-38	99	0.1	6.6	4,820	Mar 07	104
1938-39	23	0.1	1.8	1,337	Oct 30	25
1939-40	1	0.1	0.2	145	Jan 07	7
1940-41	16	0.1	2.5	1,790	Feb 19	25
1941-42	44	0.1	2.3	1,641	Dec 03	91
1942-43	141	0.1	4.2	3,063	Mar 04	287
1943-44	51	0.1	1.5	1,120	Mar 02	51
1944-45	6	0.1	0.6	393	Feb 02	10
1945-46	30	0.1	3.9	2,834	Aug 31	37
1946-47	4	0.1	0.2	129	Nov 12	6
1947-48	1	0	0.1	32	Jul 13	7
1948-49	1	0	0.1	21	Jul 22	3
1949-50	2	0	0	28	Dec 18	4
1950-51	0	0	0	11	Dec 14	3
1951-52	3	0	0.1	108	Jan 16	12
1952-53	3	0	0.2	136	Apr 20	4
1953-54	362	0	42.2	30,645	Sep 23	392
1954-55	366	0	32.4	23,299	Dec 12	404
1955-56	396	0.1	70.1	50,798	Sep 30	389
1956-57	381	0.1	74.2	53,783	Apr 26	414
1957-58	5	0	0.4	314	Apr 07	16
1958-59	3	0	0.1	60	Jan 06	11
1959-60	1	0	0.1	42	Jan 12	3
1960-61	291	0	13	9,456	Nov 16	294
1961-62	2	0	0.1	49		
1962-63	21	0	0.7	482	Nov 28	21
1963-64	0	0	0	20	Feb 19	8
1964-65	309	0	10.4	7,431	Mar 20	310

M Data missing

* Record incomplete

E Estimate

N.D. Not determined

** Record not computed

+ Less than 0.05 acre feet or less than 0.05 cfs, but greater than 0

RUNOFF – STREAM GAGING STATION PEAK FLOW

**WALNUT CREEK below Puddingstone Dam.
STATION NO. F40-R**

Season	Daily CFS			Total Runoff (Acre-feet)	Peak Flow	
	Maximum	Minimum	Mean		Date	CFS
1965-66	110	0	4.2	3,120	Dec 13	112
1966-67	157	0	13.9	10,036	May 05	159
1967-68	N.D.					
1968-69	N.D.					
1969-70	N.D.					
1970-71	N.D.					
1971-72	N.D.					
1972-73	N.D.					
1973-74	N.D.					
1974-75	94	0	0	0	Apr 11	450
1975-76	2	0	0	65	May 24	20
1976-77	15	0	0.3	214	May 18	31
1977-78	1,080	0	34.4	24,888	Mar 06	1,115
1978-79	38	0.2	5.7	4,121	Mar 09	80
1979-80	1,070	0.2	28.1	20,376	Feb 18	1,070
1980-81	32	0.1	0.7	515	Mar 01	34
1981-82	474	0.1	3.6	2,591	Mar 18	573
1982-83	550	0.1	21	15,239	Mar 01	622
1983-84	64	0.1	2.8	2,049	Feb 04	255
1984-85	205	0.1	1.2	874	Jan 13	216
1985-86	219	0.1	4.4	3,151	Mar 16	298
1986-87	151	0	2.6	1,113	Jan 14	159
1987-88	107	0.1	2.8	2,049		107
1988-89	44	0.1	2.5	1,842	Feb 10	48
1989-90	84	0.1	1.3	891	Feb 21	161
1990-91	361	0.1	3.8	2,775	Mar 27	700
1991-92	492	0.1	5.3	3,829	Feb 12	580
1992-93	608	0.1	39	28,252	Feb 19	863
1993-94	42	0.1	1.6	1,137	Dec 16	43
1994-95	779	0.1	13.7	9,926	Mar 06	834
1995-96	290	0.2	4.5	3,255	Feb 20	652
1996-97	105	0.3	5.5	3,957	Dec 30	114
1997-98	312	0.3	18.9	13,657	May 28	818

M Data missing

* Record incomplete

E Estimate

N.D. Not determined

** Record not computed

+ Less than 0.05 acre feet or less than 0.05 cfs, but greater than 0

RUNOFF – STREAM GAGING STATION PEAK FLOW

**WALNUT CREEK below Puddingstone Dam.
STATION NO. F40-R**

Season	Daily CFS			Total Runoff (Acre-feet)	Peak Flow	
	Maximum	Minimum	Mean		Date	CFS
1998-99	36	0.2	1.3	964	Oct 01	126
1999-00	131	0.3	2.5	1,809	Feb 22	230
2000-01	202	0.2	4	2,930	Mar 03	569
2001-02	20	0.4	0.9	646	Jan 04	22
2002-03	275	0.3	4.9	3,563	Mar 16	292
2003-04	57	0.6	2.1	1,550	Dec 01	83
2004-05	792	0	24.8	17,900	Jan 11	1,010
2005-06	109	0.4	3.8	2,780	Apr 06	112
2006-07	1	0	0.6	367	Apr 25	32
2007-08	158	0	5.2	3,749	Jan 28	235
2008-09	299	0	2.8	2,000	Feb 07	365
2009-10	191	0	4.2	3,030	Feb 08	202
2010-11	937	0	13.2	9,540	Dec 22	970
2011-12	62	0	0.84	613	Oct 25	894
2012-13	5	0	0.048	35	Oct 23	786
2013-14	5	0	0.082	59	Oct 29	473
2014-15	2	0	0.054	39	Nov 06	255

M Data missing

* Record incomplete

E Estimate

N.D. Not determined

** Record not computed

+ Less than 0.05 acre feet or less than 0.05 cfs, but greater than 0

APPENDIX E

HYDROLOGIC REPORT 2014 – 2015

RESERVOIRS - YEARLY RESERVOIR OPERATION SUMMARY

RESERVOIRS - YEARLY RESERVOIR OPERATION SUMMARY

Big Dalton Dam

Season	Inflow Annual (AF)	Daily Mean Inflow		Outflow Annual (AF)	Peak Inflow	
		Max-Day (CFS)	Min-Day (CFS)		Date	Q (CFS)
1929-30	52	3	0	52		N.D.
1930-31	41	2	0	41	Apr 26	3
1931-32	690	54	0	688	Feb 09	86
1932-33	79	5	0	81	Jan 20	12
1933-34	448	93	0	448	Jan 01	227
1934-35	593	21	0	575	Apr 08	49
1935-36	360	12	0	370	Feb 11	72
1936-37	1,879	51	0	1,868	Feb 06	98
1937-38	3,271	415	0	3,192	Mar 02	1,320
1938-39	280	4	0	288	Jan 05	26
1939-40	232	4	0	236	Jan 08	29
1940-41	2,767	56	+	2,748	Mar 04	88
1941-42	209	2	0	233	Mar 14	6
1942-43	3,143	160	0	3,110	Jan 23	595
1943-44	1,087	109	+	1,085	Feb 22	226
1944-45	734	19	0	729	Nov 11	47
1945-46	525	40	0	509	Dec 23	148
1946-47	492	16	0	512	Nov 20	56
1947-48	58	1	0	8	Apr 28	10
1948-49	94	1	0	113	Dec 17	3
1949-50	142	2	0	130	Feb 06	4
1950-51	27	2	+	14	Jan 11	5
1951-52	1,626	73	0	1,577	Jan 16	154
1952-53	120	1	+	68	Dec 01	5
1953-54	346	13	0	359	Jan 25	53
1954-55	87	1	+	5	Jan 18	2
1955-56	190	14	+	213	Jan 26	56
1956-57	76	1	+	27	Jan 13	2
1957-58	2,104	97	0	2,052	Apr 03	169
1958-59	160	6	+	133	Feb 16	26
1959-60	54	1	+	11	Apr 27	5
1960-61	187	18	0	1,510	Nov 05	462
1961-62	1,222	63	0	933	Dec 02	1,130
1962-63	248	20	0	159	Feb 09	92
1963-64	165	3	0	300	Mar 22	30
1964-65	380	18	0	15	Apr 09	73
1965-66	2,210	113	0	2,013	Nov 22	489

N.D. Not determined

R.I. Records incomplete

+ Less than 0.05 acre feet or less than 0.05 cfs, but greater than 0

RESERVOIRS - YEARLY RESERVOIR OPERATION SUMMARY

Big Dalton Dam

Season	Inflow Annual (AF)	Daily Mean Inflow		Outflow Annual (AF)	Peak Inflow	
		Max-Day (CFS)	Min-Day (CFS)		Date	Q (CFS)
1966-67	4,787	292	0	4,790	Dec 06	685
1967-68	771	15	0	681	Nov 19	56
1968-69	13,251	1,210	0	12,995	Jan 25	1,540
1969-70	728	15	0	610	Feb 28	91
1970-71	856	22	0	1,100	Dec 21	38
1971-72	217	10	+		Dec 27	11
1972-73	1,386	100	+	1,046	Feb 11	163
1973-74	860	43	0	1,030	Jan 07	68
1974-75	379	4	0	211	Mar 06	8
1975-76	237	6	0	467	Mar 01	17
1976-77	171	3	0	20	Jan 03	14
1977-78	6,182	232	0	6,234	Mar 04	500
1978-79	R.I.					N.D.
1979-80	R.I.					N.D.
1980-81	349	5	0	364	Jan 29	29
1981-82	1,018	50	0	923	Mar 17	53
1982-83	5,562	240	0	5,532	Mar 01	350
1983-84	703	8	0	704	Dec 25	16
1984-85	611	10	0	585	Dec 19	16
1985-86	886	20	0	865	Mar 16	26
1986-87	203	N.D.	0	196	Jan 04	N.D.
1987-88	342	7	0	324	Jan 17	17
1988-89	382	13	0	340	Feb 04	31
1989-90	112	3	0	90	Feb 17	8
1990-91	470	26	0	453	Mar 27	62
1991-92	1,259	37	0	1,243	Feb 12	121
1992-93	7,102	322	0	7,146	Jan 18	385
1993-94	369	3	0	300	Feb 07	4
1994-95	3,839	73	0	3,820	Jan 10	127
1995-96	1,247	54	0	1,215	Feb 20	96
1996-97	1,127	8	0	1,108		N.D.
1997-98	4,703	213	0	4,642	Feb 23	344
1998-99						N.D.
1999-00	718	8	0	241	Feb 23	72
2000-01	354	6	0	321	Feb 13	8
2001-02	9	1	0	27	Nov 24	3
2002-03	1,780	52	0	566	Apr 14	168

N.D. Not determined

R.I. Records incomplete

+ Less than 0.05 acre feet or less than 0.05 cfs, but greater than 0

RESERVOIRS - YEARLY RESERVOIR OPERATION SUMMARY

Big Dalton Dam

Season	Inflow Annual (AF)	Daily Mean Inflow		Outflow Annual (AF)	Peak Inflow	
		Max-Day (CFS)	Min-Day (CFS)		Date	Q (CFS)
2003-04	502	25	0	626	Feb 26	110
2004-05	8,060	494	0	7,350	Jan 09	935
2005-06	1,670	60	0	1,380	Apr 05	92
2006-07	648	9	0	823	Mar 23	13
2007-08	705	40	0	496	Jan 28	79
2008-09	594	7	0	601	Feb 07	15
2009-10	744	9	0	418	Feb 09	18
2010-11	2,730	103	0	2,050	Dec 12	212
2011-12	514	3.5	0	614	Mar 17	11
2012-13	28	3.5	0	191	Nov 30	6
2013-14	53	2.5	0	64	Dec 23	29
2014-15	6.7	1.2	0	50	Dec 02	2

N.D. Not determined

R.I. Records incomplete

+ Less than 0.05 acre feet or less than 0.05 cfs, but greater than 0

RESERVOIRS - YEARLY RESERVOIR OPERATION SUMMARY

Big Tujunga Dam

Season	Inflow Annual (AF)	Daily Mean Inflow		Outflow Annual (AF)	Peak Inflow	
		Max-Day (CFS)	Min-Day (CFS)		Date	Q (CFS)
1932-33	4,342	218	0	4,518		N.D.
1933-34	4,441	994	0	4,234	Jan 01	2,430
1934-35	11,992	380	0	10,698	Apr 08	718
1935-36	3,875	130	0	5,508	Feb 12	312
1936-37	26,969	803	0.6	25,729	Feb 06	1,740
1937-38	64,855	12,030	1	65,022	Mar 02	32,940
1938-39	9,905	327	1.2	9,106	Dec 19	666
1939-40	7,058	337	0.4	7,197	Jan 08	2,300
1940-41	59,402	1,200	0.9	59,086	Mar 04	1,570
1941-42	7,120	70	0.8	7,724	Dec 10	134
1942-43	52,877	5,700	1.1	52,919	Jan 23	17,850
1943-44	42,270	2,780	5	41,722	Feb 22	4,770
1944-45	13,206	475	1.2	12,231	Nov 11	1,850
1945-46	11,543	1,150	0.8	12,383	Mar 30	2,310
1946-47	12,987	674	0.9	12,827	Nov 13	1,690
1947-48	2,679	44	0.7	3,579	Apr 29	85
1948-49	2,129	16	0.1	1,645	Mar 11	18
1949-50	2,029	32	0.2	1,905	Feb 06	43
1950-51	841	8	0.1	1,235	Apr 29	17
1951-52	27,288	896	0.3	26,125	Jan 18	2,030
1952-53	3,496	35	0.1	4,873	Nov 15	108
1953-54	5,389	212	0.1	5,290	Jan 25	500
1954-55	2,623	30	0.2	2,282	Jan 18	52
1955-56	3,026	233	0.4	3,433	Jan 26	582
1956-57	1,967	107	0.1	1,660	Jan 13	283
1957-58	27,558	1,220	0.1	27,563	Apr 03	2,860
1958-59	3,405	172	0.1	3,152	Jan 06	213
1959-60	1,183	12	0.3	1,653	Jan 12	24
1960-61	838	14	0.4	718	Nov 06	35
1961-62	16,711	2,540	0.4	16,776	Feb 11	5,050
1962-63	1,715	90	0.2	1,359	Feb 10	237
1963-64	1,526	40	0	2,039	Jan 22	90
1964-65	2,429	60	0.4	1,503	Apr 09	165
1965-66	30,772	2,810	0.6	29,779	Dec 29	10,800
1966-67	30,158	1,180	1.6	30,338	Dec 06	2,600
1967-68	10,584	352	1	11,446	Nov 21	725
1968-69	107,609	7,800	0	106,462	Feb 25	17,800

N.D. Not determined

R.I. Records incomplete

+ Less than 0.05 acre feet or less than 0.05 cfs, but greater than 0

RESERVOIRS - YEARLY RESERVOIR OPERATION SUMMARY

Big Tujunga Dam

Season	Inflow Annual (AF)	Daily Mean Inflow		Outflow Annual (AF)	Peak Inflow	
		Max-Day (CFS)	Min-Day (CFS)		Date	Q (CFS)
1969-70	11,643	372	1.5	11,624	Mar 01	613
1970-71	12,394	1,100	2.1	11,412	Nov 29	3,970
1971-72	4,118	194	0.5	3,374	Dec 24	462
1972-73	15,375	1,914	0.5	14,680	Feb 11	6,320
1973-74	8,663	256	0.9	5,582	Jan 07	561
1974-75	5,442	198	0.3	8,666	Mar 06	315
1975-76	4,482	408	0.1	3,863	Feb 09	1,400
1976-77	3,928	164	1.2	3,547	Jan 03	878
1977-78	R.I.					N.D.
1978-79	R.I.					N.D.
1979-80	R.I.					N.D.
1980-81	10,927	226	3	11,470	Jan 29	496
1981-82	16,578	569	3.8	16,557	Mar 17	1,499
1982-83	95,294	7,065	3.8	93,880	Mar 01	10,007
1983-84	10,861	337	0	11,314	Dec 25	808
1984-85	7,362	200	0.7	6,952	Dec 19	361
1985-86	12,370	529	0.4	11,757	Jan 30	969
1986-87	2,943	28	0	2,843	Jan 04	53
1987-88	7,121	190	0	6,902	Feb 01	685
1988-89	4,300	91	0	4,208	Feb 10	131
1989-90	929	41	0	741	Feb 17	62
1990-91	8,074	530	0	7,992	Mar 01	1,871
1991-92	31,767	1,249	0.1	31,414	Feb 12	5,167
1992-93	89,492	3,490	0.2	89,311	Feb 19	7,774
1993-94	8,635	80	0	9,241	Feb 08	170
1994-95	34,562	1,005	0.2	34,532	Jan 10	3,608
1995-96	8,491	477	1.1	7,970	Feb 21	530
1996-97	9,025	156	0.3	8,080		N.D.
1997-98	48,676	3,370	0.4	48,281	Feb 23	8,288
1998-99	7,460	39	0	5,580	Feb 02	72
1999-00	5,840	166	0	5,390	Feb 21	602
2000-01	7,360	219	0	7,020	Mar 06	343
2001-02	1,190	11	0	934	Oct 23	35
2002-03	7,710	567	0	7,070	Feb 12	1,803
2003-04	2,630	335	0	2,120	Feb 26	932
2004-05	132,800	4,910	+	132,000	Jan 09	7,960
2005-06	13,910	467	0	13,790	Jan 02	1,040

N.D. Not determined

R.I. Records incomplete

+ Less than 0.05 acre feet or less than 0.05 cfs, but greater than 0

RESERVOIRS - YEARLY RESERVOIR OPERATION SUMMARY

Big Tujunga Dam

Season	Inflow Annual (AF)	Daily Mean Inflow		Outflow Annual (AF)	Peak Inflow	
		Max-Day (CFS)	Min-Day (CFS)		Date	Q (CFS)
2006-07	3,590	35	0	2,770	May 08	79
2007-08	13,280	899	0	13,220	Jan 27	1,760
2008-09	N.D.	No data due to rehabilitation project				
2009-10	N.D.	No data due to rehabilitation project				
2010-11	N.D.	No data due to rehabilitation project				
2011-12	N.D.	No data due to rehabilitation project				
2012-13	3,510	22	0	2,950	May 07	35
2013-14	3,270	298	0.2	2,350	Mar 01	725
2014-15	6,600	84	1.8	1,400	Jul 19	640

N.D. Not determined

R.I. Records incomplete

+ Less than 0.05 acre feet or less than 0.05 cfs, but greater than 0

RESERVOIRS - YEARLY RESERVOIR OPERATION SUMMARY

Cogswell Dam

Season	Inflow Annual (AF)	Daily Mean Inflow		Outflow Annual (AF)	Peak Inflow	
		Max-Day (CFS)	Min-Day (CFS)		Date	Q (CFS)
1934-35	3,517	54	0.1	3,517		N.D.
1935-36	7,154	265	0	7,138		N.D.
1936-37	32,986	943	0.1	32,996	Feb 14	1,240
1937-38	60,336	7,990	1.4	58,799	Mar 02	24,710
1938-39	11,560	673	0.9	11,369	Sep 25	1,360
1939-40	9,634	309	0.8	9,569	Jan 08	2,020
1940-41	61,270	1,400	0.5	59,951	Feb 20	1,640
1941-42	6,080	108	0.3	7,331	Dec 10	294
1942-43	54,700	2,320	0.7	53,703	Jan 23	15,000
1943-44	38,150	2,860	1.4	37,460	Feb 22	4,650
1944-45	11,887	424	1.4	10,385	Nov 11	1,600
1945-46	14,711	1,260	0.8	16,377	Mar 30	2,790
1946-47	20,135	1,030	0.1	20,135	Dec 25	2,290
1947-48	3,103	86	0.3	3,032	Apr 29	262
1948-49	2,911	32	0.3	2,765	Jan 20	65
1949-50	3,778	99	0.4	3,536	Dec 18	239
1950-51	887	10	0.3	568	Apr 29	24
1951-52	33,783	1,260	0.3	25,439	Jan 16	2,640
1952-53	4,410	70	0.8	12,345	Dec 01	254
1953-54	8,004	412	0.3	7,500	Jan 24	1,030
1954-55	3,941	51	0.3	3,165	Apr 30	176
1955-56	4,070	419	0.1	3,564	Jan 26	1,040
1956-57	3,421	225	0.2	3,757	Jan 13	685
1957-58	36,476	1,460	0	34,530	Apr 03	3,710
1958-59	4,904	340	0.4	6,205	Jan 06	1,760
1959-60	1,935	27	0.5	2,006	Jan 10	65
1960-61	1,106	36	0.4	572	Jan 26	116
1961-62	25,497	3,480	0.3	23,255	Feb 11	7,010
1962-63	3,220	153	0.6	4,783	Feb 09	1,017
1963-64	2,587	89	0.4	2,647	Apr 01	276
1964-65	5,037	266	0.3	4,159	Apr 09	479
1965-66	41,747	2,640	0.3	42,170	Dec 29	9,220
1966-67	40,504	1,860	0.6	32,757	Dec 06	4,650
1967-68	9,569	338	0.6	12,713	Nov 19	893
1968-69	95,676	6,380	0.1	90,488	Jan 25	15,700
1969-70	10,222	410	1	13,859	Feb 28	1,020
1970-71	10,822	1,030	0.8	11,683	Nov 29	2,930

N.D. Not determined

R.I. Records incomplete

+ Less than 0.05 acre feet or less than 0.05 cfs, but greater than 0

RESERVOIRS - YEARLY RESERVOIR OPERATION SUMMARY

Cogswell Dam

Season	Inflow Annual (AF)	Daily Mean Inflow		Outflow Annual (AF)	Peak Inflow	
		Max-Day (CFS)	Min-Day (CFS)		Date	Q (CFS)
1971-72	4,009	297	0.4	4,557	Dec 24	798
1972-73	19,613	2,210	0.4	16,632	Feb 11	6,970
1973-74	12,746	424	1.1	12,051	Jan 07	880
1974-75	6,610	241	1.1	8,344	Mar 06	432
1975-76	5,550	509	0.1	5,040	Feb 09	824
1976-77	4,955	206	0.3	5,000	Jan 03	421
1977-78	86,754	3,852	0	86,030	Feb 10	11,200
1978-79	23,057	519	1.9	24,083	Jan 05	N.D.
1979-80	59,867	3,028	1.8	57,887	Feb 16	6,196
1980-81	5,299	127	0	7,752	Jan 29	511
1981-82	14,258	605	0.4	9,059	Mar 17	1,238
1982-83	77,775	3,966	1.4	78,446	Mar 02	5,898
1983-84	9,561	272	2.8	12,495	Dec 25	790
1984-85	7,167	284	0	6,383	Dec 19	531
1985-86	15,584	560	0.6	15,314	Feb 15	916
1986-87	2,194	35	0.1	2,669	Jan 04	63
1987-88	11,621	282	0	10,919	Mar 01	528
1988-89	4,953	99	0	5,105	Feb 04	175
1989-90	1,903	61	0	1,775	Feb 18	99
1990-91	10,229	605	0	10,921	Mar 01	1,063
1991-92	39,922	2,352	0.2	39,922	Feb 11	5,231
1992-93	83,608	2,330	0	78,936	Feb 19	4,135
1993-94	6,896	105	0.2	11,142	Feb 08	162
1994-95	41,056	1,002	0.1	41,072	Jan 10	2,479
1995-96	8,780	496	0.1	8,777	Feb 20	1,056
1996-97	9,428	192	0.2	8,089		N.D.
1997-98	47,709	3,476	0.5	41,403	Feb 23	7,343
1998-99						N.D.
1999-00	8,210	274	0	5,370	Feb 21	562
2000-01	10,760	316	0	10,420	Feb 13	780
2001-02	1,980	22	0	3,930	Jan 27	34
2002-03	10,320	552	0.5	8,290	Feb 13	1,399
2003-04	5,820	34	1	6,780	Jan 14	81
2004-05	102,200	4,790	0.44	96,820	Jan 09	6,590
2005-06	13,340	297	0	15,340	Jan 03	478
2006-07	1,190	11	0	2,660	Feb 27	14
2007-08	16,830	1,100	0.3	13,530	Jan 27	2,150

N.D. Not determined

R.I. Records incomplete

+ Less than 0.05 acre feet or less than 0.05 cfs, but greater than 0

RESERVOIRS - YEARLY RESERVOIR OPERATION SUMMARY

Cogswell Dam

Season	Inflow Annual (AF)	Daily Mean Inflow		Outflow Annual (AF)	Peak Inflow	
		Max-Day (CFS)	Min-Day (CFS)		Date	Q (CFS)
2008-09	6,480	156	1	6,230	Feb 07	342
2009-10	36,210	1,390	0	27,930	Jan 18	7,790
2010-11	43,790	1,250	0	39,480	Dec 20	4,480
2011-12	7,960	100	0	10,190	Mar 26	822
2012-13	2,860	22	0	1,770	Jan 24	49
2013-14	1,730	202	0	813	Mar 01	487
2014-15	3,130	116	0	1,230	Jul 19	292

N.D. Not determined

R.I. Records incomplete

+ Less than 0.05 acre feet or less than 0.05 cfs, but greater than 0

RESERVOIRS - YEARLY RESERVOIR OPERATION SUMMARY

Devil's Gate Dam

Season	Inflow Annual (AF)	Daily Mean Inflow		Outflow Annual (AF)	Peak Inflow	
		Max-Day (CFS)	Min-Day (CFS)		Date	Q (CFS)
1933-34	2,938	757	0	0	Jan 01	3,310
1934-35	3,843	N.D.	0	N.D.	Oct 17	1,310
1935-36	3,457	N.D.	0	86	Feb 02	939
1936-37	12,030	340	0	2,818	Feb 06	852
1937-38	25,436	3,720	0	17,496	Mar 02	10,840
1938-39	3,044	200	0	634	Dec 19	201
1939-40	1,350	142	0	745	Jan 08	859
1940-41	27,013	1,380	0	24,582	Feb 20	3,870
1941-42	689	91	0	443	Dec 10	479
1942-43	25,655	2,560	0	23,552	Jan 23	7,740
1943-44	8,680	1,450	0	7,905	Feb 22	2,310
1944-45	2,341	288	0	2,031	Nov 11	949
1945-46	2,994	435	0	1,343	Dec 22	1,040
1946-47	4,045	285	0	3,949	Dec 25	1,280
1947-48	260	32	0	57	Mar 24	444
1948-49	185	14	0	37	Mar 10	59
1949-50	318	37	0	81	Feb 06	237
1950-51	171	18	0	17	Jan 11	468
1951-52	11,508	792	0	11,377	Jan 16	2,650
1952-53	563	51	0	194	Nov 15	823
1953-54	1,324	178	0	488	Jan 25	565
1954-55	651	50	0	154	Jan 18	334
1955-56	2,229	591	0	1,339	Jan 26	1,420
1956-57	926	111	0	142	Feb 23	795
1957-58	9,642	447	0	6,508	Apr 03	1,020
1958-59	1,055	160	0	465	Jan 06	1,280
1959-60	1,052	40	0	131	Jan 11	329
1960-61	1,035	131	0	488	Nov 06	1,260
1961-62	7,014	970	0	5,260	Feb 11	1,840
1962-63	1,215	289	0	251	Feb 09	1,290
1963-64	860	81	0	170	Jan 21	727
1964-65	1,721	170	0	246	Apr 09	755
1965-66	15,667	1,340	0	13,199	Nov 22	3,740
1966-67	16,391	934	0	6,057	Dec 06	2,130
1967-68	6,858	698	0	2,233	Nov 19	1,310
1968-69	44,817	4,220	0	39,164	Jan 25	7,910
1969-70	2,109	202	0	1,311	Mar 04	534

N.D. Not determined

R.I. Records incomplete

+ Less than 0.05 acre feet or less than 0.05 cfs, but greater than 0

RESERVOIRS - YEARLY RESERVOIR OPERATION SUMMARY

Devil's Gate Dam

Season	Inflow Annual (AF)	Daily Mean Inflow		Outflow Annual (AF)	Peak Inflow	
		Max-Day (CFS)	Min-Day (CFS)		Date	Q (CFS)
1970-71	3,098	682	0	1,894	Nov 29	1,760
1971-72	798	152	0	+	Dec 24	433
1972-73	8,298	1,517	0	5,615	Feb 11	3,520
1973-74	4,032	589	0	2,749	Jan 07	1,100
1974-75	2,024	237	0	711	Mar 06	451
1975-76	2,172	281	0	1,204	Sep 10	869
1976-77	1,682	177	0	1,593	Jan 03	587
1977-78	R.I.				Mar 04	6,941
1978-79	R.I.				Mar 28	269
1979-80	R.I.				Feb 16	2793*
1980-81	1,857	84	0	2,337	Jan 29	802
1981-82	6,574	199	0	6,569	Mar 17	272
1982-83	26,491	2,571	0	26,338	Mar 02	3,419
1983-84	937	100	0	1,074	Oct 01	105
1984-85	1,320	129	0	1,320	Dec 19	480
1985-86	2,877	166	0	2,877	Feb 15	282
1986-87	N.D.	N.D.		N.D.	Jan 04	202
1987-88	2,346	96	0	2,346	Oct 31	226
1988-89	113	18	0	113	Dec 16	54
1989-90	142	12	0	142	Feb 17	88
1990-91	4,997	523	0	4,997	Mar 01	924
1991-92	19,885	1,310	0	19,885	Feb 12	3,107
1992-93	60,794	1,134	0	60,793	Jan 17	2,213
1993-94	1,456	21	0	1,456	Feb 17	25
1994-95	21,173	1,030	0	21,173	Jan 10	2,493
1995-96	3,119	414	0	3,120	Feb 21	584
1996-97	R.I.					N.D.
1997-98	R.I.					N.D.
1998-99						N.D.
1999-00	15,780	471	0	15,780	Mar 05	818
2000-01	12,260	493	0	12,290	Feb 13	628
2001-02	1,730	66	0	1,680	Nov 24	395
2002-03	3,140	272	0	1,980	Feb 12	770
2003-04	2,070	245	0	1,600	Feb 26	1,250
2004-05	134,400	8,370	0	134,200	Jan 09	9,870
2005-06	6,570	407	0	6,150	Jan 02	1,640
2006-07	4,720	195	0	4,770	Feb 27	1,350

N.D. Not determined

R.I. Records incomplete

+ Less than 0.05 acre feet or less than 0.05 cfs, but greater than 0

RESERVOIRS - YEARLY RESERVOIR OPERATION SUMMARY

Devil's Gate Dam

Season	Inflow Annual (AF)	Daily Mean Inflow		Outflow Annual (AF)	Peak Inflow	
		Max-Day (CFS)	Min-Day (CFS)		Date	Q (CFS)
2007-08	13,960	735	0	13,360	Jan 04	5,720
2008-09	2,570	279	0	2,670	Nov 26	1,250
2009-10	19,130	1,290	0	17,320	Feb 06	5,500
2010-11	42,550	1,890	0.1	41,660	Dec 21	6,440
2011-12	2,300	93	0	1,950	Nov 20	1,040
2012-13	513	34	0	428	Oct 11	479
2013-14	824	238	0	440	Feb 28	673
2014-15	701	88	0	276	Dec 12	437

N.D. Not determined

R.I. Records incomplete

+ Less than 0.05 acre feet or less than 0.05 cfs, but greater than 0

RESERVOIRS - YEARLY RESERVOIR OPERATION SUMMARY

Eaton Wash Dam

Season	Inflow Annual (AF)	Daily Mean Inflow		Outflow Annual (AF)	Peak Inflow	
		Max-Day (CFS)	Min-Day (CFS)		Date	Q (CFS)
1936-37	3,062	112	0	1,502		N.D.
1937-38	6,993	883	0	5,213	Mar 02	2,670
1938-39	340	51	0	84	Dec 18	169
1939-40	390	31	0	96	Jan 08	220
1940-41	7,323	188	0	6,089	Feb 20	426
1941-42	78	11	0	0	Dec 10	73
1942-43	7,212	498	0	6,399	Jan 23	1,700
1943-44	2,901	265	0	1,970	Feb 22	371
1944-45	331	52	0	101	Nov 11	204
1945-46	514	77	0	265	Dec 23	284
1946-47	746	74	0	507	Nov 13	286
1947-48	64	11	0	5	Apr 28	90
1948-49	36	5	0	1	Jan 20	10
1949-50	188	23	0	61	Dec 18	88
1950-51	44	4	0	8	Jan 11	80
1951-52	2,636	151	0	2,020	Jan 16	495
1952-53	145	18	0	0	Dec 01	225
1953-54	533	56	0	202	Jan 19	220
1954-55	146	14	0	0	Jan 18	91
1955-56	330	123	0	151	Jan 26	422
1956-57	127	20	0	9	Feb 23	138
1957-58	3,114	150	0	2,248	Apr 01	443
1958-59	301	46	0	152	Jan 06	702
1959-60	60	6	0	0	Jan 11	48
1960-61	61	10	0	0	Jan 26	39
1961-62	1,729	322	0	1,299	Feb 11	737
1962-63	177	51	0	19	Feb 09	198
1963-64	222	38	0	33	Jan 22	246
1964-65	534	49	0	328	Apr 09	220
1965-66	5,400	415	0	4,267	Dec 29	1,520
1966-67	3,856	317	0	1,907	Dec 06	595
1967-68	1,304	133	0	404	Nov 19	331
1968-69	20,866	1,110	0	18,644	Jan 25	2,540
1969-70	718	90	0	527	Mar 05	878
1970-71	809	178	0	581	Nov 29	457
1971-72	207	42	0	+	Dec 27	107
1972-73	4,299	532	0	2,844	Feb 11	587

N.D. Not determined

R.I. Records incomplete

+ Less than 0.05 acre feet or less than 0.05 cfs, but greater than 0

RESERVOIRS - YEARLY RESERVOIR OPERATION SUMMARY

Eaton Wash Dam

Season	Inflow Annual (AF)	Daily Mean Inflow		Outflow Annual (AF)	Peak Inflow	
		Max-Day (CFS)	Min-Day (CFS)		Date	Q (CFS)
1973-74	2,420	200	0	1,607	Jan 07	309
1974-75	672	79	0	418	Mar 06	81
1975-76	893	74	0	424	Mar 01	175
1976-77	461	36	0	281	Jan 03	191
1977-78	R.I.					N.D.
1978-79	R.I.					N.D.
1979-80	R.I.					N.D.
1980-81	578	45	0	587	Mar 01	195
1981-82	1,676	121	0	1,530	Mar 17	200
1982-83	19,050	732	0	18,941	Mar 02	1,982
1983-84	1,918	61	0	1,929	Dec 25	188
1984-85	701	23	0	698	Dec 19	23
1985-86	1,937	56	0	1,933	Jan 30	223
1986-87	N.D.	27	0	N.D.	Jan 04	N.D.
1987-88	848	55	0	649	Feb 01	228
1988-89	322	26	0	182	Dec 16	74
1989-90	233	40	0	131	Feb 17	63
1990-91	1,602	127	0	1,589	Mar 01	239
1991-92	5,693	295	0	5,678	Feb 11	1,068
1992-93	14,662	340	0	14,661	Jan 07	937
1993-94	1,100	26	0	984	Feb 08	51
1994-95	7,500	225	0	7,461	Jan 10	757
1995-96	1,891	158	0	1,865	Feb 20	266
1996-97	R.I.					N.D.
1997-98	6,514	308	0	6,514	Feb 23	1,418
1998-99						N.D.
1999-00	886	60	0	712	Feb 20	232
2000-01	965	77	0	797	Feb 13	179
2001-02	158	26	0	115	Nov 24	217
2002-03	832	95	0	518	Mar 15	244
2003-04	560	98	0	300	Feb 26	363
2004-05	11,870	259	0	11,170	Oct 20	593
2005-06	1,900	75	0	1,470	Mar 28	223
2006-07	106	11	0	16	Feb 11	110
2007-08	2,160	141	0	1,940	Jan 05	803
2008-09	566	73	0	368	Nov 26	222
2009-10	2,960	135	0	2,280	Jan 18	706

N.D. Not determined

R.I. Records incomplete

+ Less than 0.05 acre feet or less than 0.05 cfs, but greater than 0

RESERVOIRS - YEARLY RESERVOIR OPERATION SUMMARY

Eaton Wash Dam

Season	Inflow Annual (AF)	Daily Mean Inflow		Outflow Annual (AF)	Peak Inflow	
		Max-Day (CFS)	Min-Day (CFS)		Date	Q (CFS)
2010-11	5,480	323	0	4,570	Dec 20	741
2011-12	321	23	0	56	Nov 06	163
2012-13	62	7	0	41	Mar 08	47
2013-14	130	48	0	84	Feb 28	238
2014-15	234	35	0	136	Dec 02	133

N.D. Not determined

R.I. Records incomplete

+ Less than 0.05 acre feet or less than 0.05 cfs, but greater than 0

RESERVOIRS - YEARLY RESERVOIR OPERATION SUMMARY

Live Oak Dam

Season	Inflow Annual (AF)	Daily Mean Inflow		Outflow Annual (AF)	Peak Inflow	
		Max-Day (CFS)	Min-Day (CFS)		Date	Q (CFS)
1932-33	0	0	0	0		0
1933-34	N.D.	N.D.	N.D.	142		N.D.
1934-35	27	2	0	27	Apr 08	16
1935-36	N.D.	4	0	0		N.D.
1936-37	494	35	0	413	Feb 06	139
1937-38	800	147	0	785	Mar 02	339
1938-39	21	1	0	3	Feb 03	1
1939-40	16	1	0	1	Jan 08	11
1940-41	719	39	0	718	Mar 04	90
1941-42	0	+	+	0		+
1942-43	827	78	0	827	Jan 22	170
1943-44	218	33	0	218	Feb 22	74
1944-45	177	9	0	177	Feb 02	67
1945-46	105	22	0	89	Dec 23	127
1946-47	64	8	0	45	Nov 20	25
1947-48	0	0	0	0		N.D.
1948-49	0	0	0	0		N.D.
1949-50	5	0	0	4	Dec 19	3
1950-51	0	0	0	0		N.D.
1951-52	362	34	0	343	Jan 16	148
1952-53	2	+	0	3	Dec 01	1
1953-54	78	13	0	64	Jan 25	82
1954-55	0	+	0	0		N.D.
1955-56	77	25	0	72	Jan 26	128
1956-57	2	0	0	0	Jan 13	1
1957-58	699	38	0	699	Apr 03	67
1958-59	6	1	0	5	Jan 06	9
1959-60	0	0	0	0		N.D.
1960-61	5	1	0	0	Nov 06	22
1961-62	186	29	0	111	Nov 20	366
1962-63	13	6	0	5	Feb 09	23
1963-64	5	1	0	0	Mar 22	6
1964-65	20	7	0	15	Apr 09	58
1965-66	243	23	0	241	Nov 22	116
1966-67	699	112	+	672	Dec 06	360
1967-68	131	6	0	130	Mar 08	39
1968-69	2,146	152	0	2,115	Jan 25	403

N.D. Not determined

R.I. Records incomplete

+ Less than 0.05 acre feet or less than 0.05 cfs, but greater than 0

RESERVOIRS - YEARLY RESERVOIR OPERATION SUMMARY

Live Oak Dam

Season	Inflow Annual (AF)	Daily Mean Inflow		Outflow Annual (AF)	Peak Inflow	
		Max-Day (CFS)	Min-Day (CFS)		Date	Q (CFS)
1969-70	258	8	0	258	Feb 28	14
1970-71	243	7	0	243	Dec 21	16
1971-72	71	4	0	71	Dec 24	5
1972-73	291	34	0	290	Feb 11	52
1973-74	132	13	0	132	Jan 07	31
1974-75	71	2	0	61	Mar 06	14
1975-76	30	3	0	24	Mar 01	7
1976-77	32	2	0	33	Jan 03	13
1977-78	1,517	71	0	1,517	Mar 04	187
1978-79	655	18	0	655	Mar 27	43
1979-80	R.I.					N.D.
1980-81	240	3	0	237	Mar 02	4
1981-82	421	19	0	421	Mar 18	32
1982-83	1,778	72	0	1,780	Mar 01	144
1983-84	447	12	0	448	Dec 25	47
1984-85	162	4	0	162	Dec 19	5
1985-86	192	4	0	192	Feb 16	7
1986-87	37	1	0	37	Jan 04	10
1987-88	70	3	0	69	Jan 17	4
1988-89	96	6	0	93	Feb 04	11
1989-90	51	2	0	51	Feb 17	3
1990-91	205	22	0	204	Mar 01	44
1991-92	277	26	0	277	Feb 12	112
1992-93	1,762	55	0	1,759	Jan 07	68
1993-94	230	3	0	235	Mar 19	17
1994-95	820	32	0	820	Jan 10	86
1995-96	357	37	0	357	Feb 20	75
1996-97	R.I.	R.I.				N.D.
1997-98	813	48	0	773	Feb 23	159
1998-99	18	1	0	104	Dec 08	21
1999-00	81	4	0	78	Feb 21	13
2000-01	61	7	0	120	Feb 13	11
2001-02	5	1	0	2	Jan 28	4
2002-03	157	23	0	49	Mar 16	201
2003-04	200	28	0	230	Feb 26	169
2004-05	2,970	155	0	2,920	Feb 11	339
2005-06	784	19	0	813	Apr 03	305

N.D. Not determined

R.I. Records incomplete

+ Less than 0.05 acre feet or less than 0.05 cfs, but greater than 0

RESERVOIRS - YEARLY RESERVOIR OPERATION SUMMARY

Live Oak Dam

Season	Inflow Annual (AF)	Daily Mean Inflow		Outflow Annual (AF)	Peak Inflow	
		Max-Day (CFS)	Min-Day (CFS)		Date	Q (CFS)
2006-07	995	4	0	993	Apr 20	5
2007-08	566	20	0	632	Jan 05	102
2008-09	325	4	0	314	Feb 16	13
2009-10	404	10	0	352	Feb 06	26
2010-11	858	27	0	781	Dec 22	181
2011-12	1,120	4	0	1,130	Apr 13	6
2012-13	122 Est	1	0	150	May 26	1
2013-14	0.4	0.2	0	0.5	Feb 28	2
2014-15	1.1	0.5	0	3.2	Feb 23	1

N.D. Not determined

R.I. Records incomplete

+ Less than 0.05 acre feet or less than 0.05 cfs, but greater than 0

RESERVOIRS - YEARLY RESERVOIR OPERATION SUMMARY

Morris Dam

Season	Inflow Annual (AF)	Daily Mean Inflow		Outflow Annual (AF)	Peak Inflow	
		Max-Day (CFS)	Min-Day (CFS)		Date	Q (CFS)
1937-38	339,303	18,590	0	337,955	Mar 02	70,300
1938-39	62,367	890	0	75,278	Dec 20	N.D.
1939-40	41,367	439	1	51,030	Mar 06	N.D.
1940-41	294,818	4,137	1	263,819	Feb 20	4,230
1941-42	21,562	419	0.1	16,504	Nov 07	N.D.
1942-43	251,552	10,380	0	247,717	Jan 23	12,660
1943-44	149,889	2,667	0	147,194	May 25	5,840
1944-45	49,942	1,291	0	47,340	Mar 26	3,590
1945-46	53,467	987	0	62,578	Apr 04	4,880
1946-47	60,442	3,369	0	55,718	Dec 28	9,300
1947-48	14,004	973	0	17,392	Dec 12	2,380
1948-49	5,387	799	0	3,777	Jun 02	N.D.
1949-50	1,901	70	0	834	Dec 05	N.D.
1950-51	5,066	180	0	3,446	Apr 21	N.D.
1951-52	76,910	3,188	0	69,966	Jan 16	5,200
1952-53	47,762	1,003	0	52,075	Nov 03	1,280
1953-54	30,334	1,574	0	29,069	Apr 10	3,590
1954-55	1,593	299	0	557	Apr 15	N.D.
1955-56	3,994	491	0	816	Sep 19	N.D.
1956-57	9,962	659	0	10,574	Apr 12	667
1957-58	216,335	2,418	0	213,390	Apr 05	2,740
1958-59	10,152	378	0	9,665	Feb 16	444
1959-60	2,688	359	0	994	Jul 09	N.D.
1960-61	6,006	459	0	889	May 16	N.D.
1961-62	74,783	1,847	0	73,031	Feb 15	2,160
1962-63	1,708	99	0	1,957	Feb 09	N.D.
1963-64	1,001	36	0	922	Jan 21	N.D.
1964-65	10,093	1,426	0	8,908	Jun 05	1,430
1965-66	200,376	9,263	0	193,965	Dec 29	10,330
1966-67	203,232	3,872	0	193,246	Dec 06	5,320
1967-68	35,015	567	0	32,902	May 06	675
1968-69	554,905	19,290	12	554,687	Feb 25	29,690
1969-70	68,267	1,558	0	66,131	Mar 01	1,800
1970-71	27,828	496	0	31,319	Dec 29	497
1971-72	21,193	298	0	15,445	Jan 05	302
1972-73	1,107,052	840	0	114,349	Feb 11	924
1973-74	27,471	1,054	0	30,553	Jan 08	3,410

N.D. Not determined

R.I. Records incomplete

+ Less than 0.05 acre feet or less than 0.05 cfs, but greater than 0

RESERVOIRS - YEARLY RESERVOIR OPERATION SUMMARY

Morris Dam

Season	Inflow Annual (AF)	Daily Mean Inflow		Outflow Annual (AF)	Peak Inflow	
		Max-Day (CFS)	Min-Day (CFS)		Date	Q (CFS)
1974-75	9,838	313	0.2	7,366	Nov 20	389
1975-76	2,270	47	0.2	2,110	Sep 30	125
1976-77						N.D.
1977-78						N.D.
1978-79						N.D.
1979-80						N.D.
1980-81						N.D.
1981-82						N.D.
1982-83						N.D.
1983-84						N.D.
1984-85						N.D.
1985-86						N.D.
1986-87						N.D.
1987-88						N.D.
1988-89						N.D.
1989-90						N.D.
1990-91						N.D.
1991-92						N.D.
1992-93						N.D.
1993-94						N.D.
1994-95	207,136	3,858	1.3	201,716	Jan 10	N.D.
1995-96	41,898	454	1.3	47,242	Feb 20	N.D.
1996-97	38,827	313	1.5	38,822		N.D.
1997-98	197,600	5,390	0	209,900	Feb 23	10,800
1998-99	35,930	233	0	15,000	Feb 16	418
1999-00	22,540	266	0	25,240	Dec 30	997
2000-01	24,550	251	0	19,830	Feb 13	156
2001-02	3,330	28	0	4,890	Jan 27	115
2002-03	42,050	861	0	34,400	Nov 19	1,590
2003-04	35,130	447	0	29,600	Oct 10	717
2004-05	408,300	9,050	0	407,900	Feb 20	11,600
2005-06	91,830	1,040	0	85,710	May 07	2,770
2006-07	9,110	164	0	11,370	Feb 16	220
2007-08	74,490	514	0	68,630	Apr 23	1,330
2008-09	21,850	365	0	28,360	Oct 01	512
2009-10	100,700	702	0	101,000	Feb 25	782
2010-11	179,800	1,860	0	172,300	Dec 25	2,500

N.D. Not determined

R.I. Records incomplete

+ Less than 0.05 acre feet or less than 0.05 cfs, but greater than 0

RESERVOIRS - YEARLY RESERVOIR OPERATION SUMMARY

Morris Dam

Season	Inflow Annual (AF)	Daily Mean Inflow		Outflow Annual (AF)	Peak Inflow	
		Max-Day (CFS)	Min-Day (CFS)		Date	Q (CFS)
2011-12	23,930	419	0	24,880	Nov 08	1,380
2012-13	9,370	660	0	11,040	Dec 27	729
2013-14	15,490	128	0	12,900	May 06	440 estimated
2014-15	4,000	73	0	4,460	Sep 16	188

N.D. Not determined

R.I. Records incomplete

+ Less than 0.05 acre feet or less than 0.05 cfs, but greater than 0

RESERVOIRS - YEARLY RESERVOIR OPERATION SUMMARY

Pacoima Dam

Season	Inflow Annual (AF)	Daily Mean Inflow		Outflow Annual (AF)	Peak Inflow	
		Max-Day (CFS)	Min-Day (CFS)		Date	Q (CFS)
1929-30	1,110	N.D.	N.D.	965		N.D.
1930-31	1,082	N.D.	N.D.	886		N.D.
1931-32	8,741	N.D.	N.D.	8,443		N.D.
1932-33	2,160	101	0	2,119		N.D.
1933-34	3,454	N.D.	N.D.	3,493	Jan 01	914
1934-35	5,569	84	0	5,556		N.D.
1935-36	3,098	88	0	3,094	Feb 12	248
1936-37	15,737	356	0	14,210	Feb 14	508
1937-38	25,878	2,360	0	26,796	Mar 02	8,320
1938-39	3,525	86	0	3,080	Dec 19	145
1939-40	3,209	156	0	3,133	Jan 08	928
1940-41	25,785	536	0	25,942	Mar 04	815
1941-42	1,920	48	0.1	2,032	Dec 29	85
1942-43	20,698	1,250	0.1	20,407	Jan 23	2,650
1943-44	15,004	898	0.4	15,167	Feb 22	1,790
1944-45	4,866	206	0.4	4,911	Feb 02	494
1945-46	4,600	332	0	2,904	Mar 30	564
1946-47	4,356	149	0	6,029	Nov 20	282
1947-48	369	6	0.1	335	Apr 29	12
1948-49	723	10	0.1	740	Mar 05	17
1949-50	1,063	19	0.1	1,019	Feb 06	26
1950-51	142	1	0	69	Apr 29	2
1951-52	16,794	681	0	4,325	Jan 16	1,290
1952-53	967	9	0	3,500	Dec 01	32
1953-54	2,952	107	0.1	2,941	Jan 25	272
1954-55	748	18	0.1	737	Apr 30	25
1955-56	1,466	90	0	1,252	Jan 27	179
1956-57	573	10	0	773	Jan 13	14
1957-58	15,818	714	0	15,808	Apr 03	1,180
1958-59	783	29	0	708	Jan 06	184
1959-60	131	1	0	271	Jan 11	2
1960-61	59	6	0	11	Nov 12	60
1961-62	6,326	584	0.1	6,279	Feb 11	811
1962-63	384	8	0.1	228	Feb 10	19
1963-64	529	8	0.1	722	Jan 22	56
1964-65	1,313	70	0.1	1,048	Apr 09	160
1965-66	15,553	647	0	15,214	Nov 22	2,010

N.D. Not determined

R.I. Records incomplete

+ Less than 0.05 acre feet or less than 0.05 cfs, but greater than 0

RESERVOIRS - YEARLY RESERVOIR OPERATION SUMMARY

Pacoima Dam

Season	Inflow Annual (AF)	Daily Mean Inflow		Outflow Annual (AF)	Peak Inflow	
		Max-Day (CFS)	Min-Day (CFS)		Date	Q (CFS)
1966-67	23,605	698	0.4	23,600	Dec 06	1,380
1967-68	3,843	76	0	3,833	Nov 21	107
1968-69	43,398	2,860	0	42,998	Feb 25	4,710
1969-70	2,717	99	0.4	2,308	Mar 01	276
1970-71	4,806	118	0.5	4,994	Nov 29	384
1971-72	1,062	36	0.2	802	Dec 26	91
1972-73	7,726	696	0.1	7,383	Feb 11	1,640
1973-74	4,197	168	0.2	4,154	Jan 08	532
1974-75	2,279	48	0.1	2,526	Mar 06	97
1975-76	1,622	58	0.1	1,614	Feb 09	102
1976-77	1,424	43	0.3	507	Jan 03	213
1977-78	R.I.					N.D.
1978-79	R.I.					N.D.
1978-80	R.I.					N.D.
1980-81	2,731	66	0	3,440	Jan 29	167
1981-82	5,979	226	0.3	4,867	Mar 17	590
1982-83	43,336	2,359	0.5	44,566	Mar 01	4,671
1983-84	3,521	88	0.2	1,386	Dec 25	153
1984-85	2,853	79	0	3,651	Dec 20	104
1985-86	7,886	279	0	7,015	Feb 15	N.D.
1986-87	638	7	0	224	Jan 04	9
1987-88	3,522	52	0.1	3,441	Oct 23	93
1988-89	2,398	40	0	2,065	Feb 04	72
1989-90	784	27	0	817	Feb 17	59
1990-91	3,520	127	0	3,222	Mar 27	140
1991-92	N.D.	708	0	N.D.	Feb 10	1,180
1992-93	40,473	929	0.1	39,814	Jan 13	1,186
1993-94	2,465	27	0	3,354	Feb 08	46
1994-95	23,547	351	0	23,710	Jan 10	1,073
1995-96	7,655	389	0	7,710	Feb 21	532
1996-97	6,497	163	1.2	5,417		N.D.
1997-98	29,980	1,250	0	29,760	Feb 23	3,040
1998-99	3,600	46	0.4	2,110	Jan 08	109
1999-00	2,520	56	0	1,830	Feb 22	80
2000-01	3,190	62	0	2,710	Feb 14	79
2001-02	450	7	0	408	Jan 27	25
2002-03	4,280	79	0	2,650	Feb 12	265

N.D. Not determined

R.I. Records incomplete

+ Less than 0.05 acre feet or less than 0.05 cfs, but greater than 0

RESERVOIRS - YEARLY RESERVOIR OPERATION SUMMARY

Pacoima Dam

Season	Inflow Annual (AF)	Daily Mean Inflow		Outflow Annual (AF)	Peak Inflow	
		Max-Day (CFS)	Min-Day (CFS)		Date	Q (CFS)
2003-04	1,710	81	0	1,320	Feb 26	201
2004-05	53,180	2,280	0	52,750	Jan 09	3,930
2005-06	10,490	272	0	8,230	Jan 02	382
2006-07	256	4	0	138	Sep 23	22
2007-08	7,620	482	0	6,870	Jan 28	716
2008-09	2,900	59	0	2,950	Feb 19	69
2009-10	11,250	251	0	10,470	Jan 18	1,080
2010-11	23,880	465	0.1	23,630	Mar 20	766
2011-12	3,010	30	0.4	2,440	Mar 25	64
2012-13	658	7	0	428	Oct 11	11
2013-14	849	83	0	549	Feb 28	352
2014-15	212	5.7	0	31	Dec 17	52

N.D. Not determined

R.I. Records incomplete

+ Less than 0.05 acre feet or less than 0.05 cfs, but greater than 0

RESERVOIRS - YEARLY RESERVOIR OPERATION SUMMARY

Puddingstone Dam

Season	Inflow Annual (AF)	Daily Mean Inflow		Outflow Annual (AF)	Peak Inflow	
		Max-Day (CFS)	Min-Day (CFS)		Date	Q (CFS)
1928-29	114	12	0	151		N.D.
1929-30	295	15	0	223		N.D.
1930-31	73	9	0	119		N.D.
1931-32	1,547	162	0	1,086		N.D.
1932-33	314	30	0	906		N.D.
1933-34	2,669	596	0	1,809		N.D.
1934-35	610	N.D.	N.D.	846	Jan 15	205
1935-36	703	54	0	969	Apr 10	590
1936-37	5,732	303	0	2,173	Feb 06	1,480
1937-38	12,221	2,200	0	7,544	Mar 02	5,310
1938-39	1,576	101	0	5,305		N.D.
1939-40	646	54	0	2,524	Jan 07	448
1940-41	12,030	377	0	3,308	Mar 04	1,080
1941-42	475	30	0	4,385	Dec 10	409
1942-43	10,043	1,130	0	4,836	Jan 23	2,300
1943-44	3,408	525	0	3,178	Feb 22	1,030
1944-45	1,615	139	0	2,376	Nov 11	484
1945-46	1,591	275	0	6,009	Dec 23	929
1946-47	1,414	96	0	788	Nov 13	445
1947-48	324	31	0	362	Dec 05	195
1948-49	336	21	0	201	Mar 13	240
1949-50	493	55	0	140	Feb 06	178
1950-51	182	15	0	145	Jan 29	162
1951-52	4,673	353	0	1,857	Jan 16	952
1952-53	928	32	0	1,140	Dec 01	358
1953-54	31,282	244	0	31,609	Jan 25	600
1954-55	26,065	255	0	23,287	Nov 11	338
1955-56	57,309	458	0	50,771	Jan 26	1,360
1956-57	50,583	216	0	53,781	Jan 13	262
1957-58	6,670	302	0	1,976	Apr 03	690
1958-59	394	68	0	72	Jan 06	871
1959-60	837	80	0	40	Jan 12	148
1960-61	10,900	198	0	9,416	Nov 06	N.D.
1961-62	4,463	173	0	33	Dec 02	963
1962-63	927	139	0	464	Feb 10	325
1963-64	594	43	0	0	Jan 22	242
1964-65	2,675	153	0	7,401	Apr 09	1,770

N.D. Not determined

R.I. Records incomplete

+ Less than 0.05 acre feet or less than 0.05 cfs, but greater than 0

RESERVOIRS - YEARLY RESERVOIR OPERATION SUMMARY

Puddingstone Dam

Season	Inflow Annual (AF)	Daily Mean Inflow		Outflow Annual (AF)	Peak Inflow	
		Max-Day (CFS)	Min-Day (CFS)		Date	Q (CFS)
1965-66	10,456	444	0	3,066	Nov 22	1,590
1966-67	11,508	1,090	0	9,988	Dec 06	2,440
1967-68	15,811	174	0	14,275	Mar 08	760
1968-69	36,802	2,830	0	35,754	Jan 25	4,340
1969-70	1,650	163	0.2	+	Mar 01	507
1970-71	1,494	149	0.1	4,094	Dec 18	365
1971-72	1,007	186	+	+	Dec 24	538
1972-73	4,038	341	0.1	+	Feb 11	604
1973-74	2,409	310	0.1	1,069	Jan 07	660
1974-75	1,832	153	0	1,832	Dec 04	769
1975-76	2,644	180	0.1	0	Sep 10	493
1976-77	2,655	138	0.1	197	Jan 03	812
1977-78	R.I					N.D.
1978-79	R.I					N.D.
1979-80	R.I					N.D.
1980-81	2,115	154	0	515	Jan 29	1,132
1981-82	4,731	350	0	2,598	Mar 18	810
1982-83	15,956	764	0	15,238	Mar 01	2,570
1983-84	2,791	192	0	2,048	Dec 25	1,159
1984-85	2,688	143	0	873	Dec 18	236
1985-86	4,888	241	0	3,150	Mar 16	1,058
1986-87	1,989	291	0	1,118	Jan 04	854
1987-88	4,010	143	0	2,373	Jan 17	422
1988-89	3,539	117	0	2,045	Feb 04	211
1989-90	2,545	235	0	977	Feb 17	683
1990-91	4,461	371	0	2,932	Mar 01	1,270
1991-92	6,781	407	0	5,333	Feb 12	959
1992-93	30,324	909	0	28,674	Jan 18	1,992
1993-94	2,884	78	0.1	1,322	Feb 07	212
1994-95	11,261	537	0.1	9,927	Jan 10	1,411
1995-96	4,587	438	0	3,275	Feb 20	1,460
1996-97	4,690	171	0	3,960	Jan 25	307
1997-98	18,560	638	0	16,570	Feb 23	1,240
1998-99	1,360	58	0	967	Feb 10	338
1999-00	2,950	187	0	1,810	Feb 24	803
2000-01	3,790	203	0	2,930	Jan 11	598
2001-02	1,470	117	0	646	Nov 24	184

N.D. Not determined

R.I. Records incomplete

+ Less than 0.05 acre feet or less than 0.05 cfs, but greater than 0

RESERVOIRS - YEARLY RESERVOIR OPERATION SUMMARY

Puddingstone Dam

Season	Inflow Annual (AF)	Daily Mean Inflow		Outflow Annual (AF)	Peak Inflow	
		Max-Day (CFS)	Min-Day (CFS)		Date	Q (CFS)
2002-03	5,540	368	0	3,560	Mar 16	534
2003-04	3,510	172	0	1,550	Feb 26	242
2004-05	19,800	796	0	17,890	Feb 19	1,320
2005-06	6,050	209	0	2,790	Mar 28	917
2006-07	5,180	78	0	438	Jan 31	516
2007-08	810	312	0	3,750	Jan 05	2,070
2008-09	3,050	175	0	2,000	Feb 05	1,370
2009-10	4,840	324	0	3,030	Feb 06	1,800
2010-11	10,460	781	0	9,540	Dec 22	1,270
2011-12	2,630	99	0	613	Oct 05	389
2012-13	1,570	42	0	35	Dec 13	234
2013-14	1,670	183	0	59	Feb 28	817
2014-15	2,980	120	0	39	Dec 02	489

N.D. Not determined

R.I. Records incomplete

+ Less than 0.05 acre feet or less than 0.05 cfs, but greater than 0

RESERVOIRS - YEARLY RESERVOIR OPERATION SUMMARY

Puddingstone Diversion Dam

Season	Inflow Annual (AF)	Daily Mean Inflow		Outflow Annual (AF)	Peak Inflow	
		Max-Day (CFS)	Min-Day (CFS)		Date	Q (CFS)
1935-36	304	48	0	304	Apr 10	85
1936-37	5,019	104	0	4,646		N.D.
1937-38	11,697	1,640	0	11,506	Mar 02	5,760
1938-39	1,288	28	0	1,293	Jan 10	N.D.
1939-40	350	26	0	155	Jan 08	33
1940-41	7,213	133	0	6,776	Mar 14	155
1941-42	341	13	0	203	Dec 12	24
1942-43	8,593	970	0	7,939	Jan 23	2,040
1943-44	3,406	357	0	3,010	Feb 22	724
1944-45	1,719	64	0	1,294	Feb 02	88
1945-46	970	159	0	773	Dec 23	234
1946-47	1,400	55	0	1,109	Dec 26	58
1947-48	0	0	0	0		N.D.
1948-49	0	0	0	0		N.D.
1949-50	0	0	0	0		N.D.
1950-51	0	0	0	0		N.D.
1951-52	3,366	158	0	2,910	Jan 16	201
1952-53	0	0	0	0		N.D.
1953-54	628	57	0	429	Feb 14	82
1954-55	0	0	0	0		N.D.
1955-56	196	34	0	128	Jan 26	93
1956-57	0	0	0	0		N.D.
1957-58	5,938	227	0	5,172	Apr 03	284
1958-59	89	14	0	49	Feb 18	18
1959-60	0	0	0	0		N.D.
1960-61	146	11	0	64	Nov 26	137
1961-62	3,277	152	0	3,106	Nov 20	2,110
1962-63	827	95	0	515	Feb 09	640
1963-64	112	19	0	67	Jan 22	55
1964-65	873	69	0	538	Apr 09	239
1965-66	6,471	320	0	5,864	Nov 22	864
1966-67	13,656	958	0	12,140	Dec 06	2,230
1967-68	2,744	62	0	2,180	Nov 30	125
1968-69	35,110	2,610	0	34,200	Jan 25	5,600
1969-70	4,005	27	0	2,788	Mar 04	62
1970-71	2,181	35	0	1,524	Dec 21	61
1971-72	764	15	0	488	Dec 24	56

N.D. Not determined

R.I. Records incomplete

+ Less than 0.05 acre feet or less than 0.05 cfs, but greater than 0

RESERVOIRS - YEARLY RESERVOIR OPERATION SUMMARY

Puddingstone Diversion Dam

Season	Inflow Annual (AF)	Daily Mean Inflow		Outflow Annual (AF)	Peak Inflow	
		Max-Day (CFS)	Min-Day (CFS)		Date	Q (CFS)
1972-73	3,746	163	0	3,321	Feb 11	219
1973-74	1,660	75	0	1,371	Jan 07	110
1974-75	969	15	0	786	Mar 06	46
1975-76	423	9	0	333	Mar 01	16
1976-77	844	29	0	578	Jan 03	57
1977-78	R.I.					N.D.
1978-79	R.I.					N.D.
1979-80	R.I.					N.D.
1980-81	2,025	21	0	1,877	Jan 29	44
1981-82	2,856	122	0	2,831	Mar 18	260
1982-83	18,257	705	0	18,272	Mar 01	1,867
1983-84	3,267	54	0	3,259	Dec 25	84
1984-85	1,353	37	0	1,294	Dec 18	40
1985-86	1,324	99	0	1,201	Mar 16	104
1986-87	686	18	0	702	Jan 04	49
1987-88	927	38	0	823	Jan 17	214
1988-89	1,060	76	0	927	Feb 04	111
1989-90	228	48	0	193	Feb 17	78
1990-91	2,079	54	0	2,024	Feb 28	195
1991-92	3,289	163	0	3,277	Feb 12	264
1992-93	25,714	698	0	25,686	Jan 18	757
1993-94	1,475	14	0	1,488	Feb 07	23
1994-95	11,349	211	0	11,349	Jan 10	252
1995-96	3,045	71	0	3,044	Feb 20	161
1996-97	2,520	84	0	2,480	Apr 11	95
1997-98	13,280	557	0	13,080	Feb 24	730
1998-99	1,750	50	0	1,470	Apr 07	135
1999-00	904	56	0	765	Jun 15	186
2000-01	986	35	0	841	Mar 02	63
2001-02	146	19	0	53	Jun 10	107
2002-03	2,230	136	0	2,030	Mar 16	182
2003-04	1,300	48	0	1,100	Dec 25	240
2004-05	25,880	1,440	0	25,700	Jan 09	1,920
2005-06	4,320	129	0	4,230	Apr 04	193
2006-07	442	8	0	387	Jan 23	10
2007-08	4,180	162	0	4,060	Jan 05	350
2008-09	1,210	29	0	1,200	Dec 15	69

N.D. Not determined

R.I. Records incomplete

+ Less than 0.05 acre feet or less than 0.05 cfs, but greater than 0

RESERVOIRS - YEARLY RESERVOIR OPERATION SUMMARY

Puddingstone Diversion Dam

Season	Inflow Annual (AF)	Daily Mean Inflow		Outflow Annual (AF)	Peak Inflow	
		Max-Day (CFS)	Min-Day (CFS)		Date	Q (CFS)
2009-10	2,390	64	0	2,330	May 07	93
2010-11	8,160	350	0	8,160	Dec 22	584
2011-12	443	9.5	0	455	Apr 30	71
2012-13	133	7.7	0	118	Apr 09	21
2013-14	153	31	0	36	Jul 03	142
2014-15	132	12	0	115	May 07	16

N.D. Not determined

R.I. Records incomplete

+ Less than 0.05 acre feet or less than 0.05 cfs, but greater than 0

RESERVOIRS - YEARLY RESERVOIR OPERATION SUMMARY

San Dimas Dam

Season	Inflow Annual (AF)	Daily Mean Inflow		Outflow Annual (AF)	Peak Inflow	
		Max-Day (CFS)	Min-Day (CFS)		Date	Q (CFS)
1928-29	N.D.	N.D.	0	N.D.		N.D.
1929-30	591	28	0	573		N.D.
1930-31	585	23	0	466		N.D.
1931-32	2,502	162	0	2,496		N.D.
1932-33	652	50	0	648		N.D.
1933-34	1,351	229	0	1,357	Jan 01	422
1934-35	1,753	60	0	1,682	Apr 08	145
1935-36	1,094	35	0	1,136	Feb 11	155
1936-37	6,316	154	0	6,126	Feb 06	296
1937-38	12,492	1,600	0.4	12,494	Mar 02	4,920
1938-39	2,165	43	0.2	2,024	Jan 05	80
1939-40	1,532	60	0	1,600	Jan 08	302
1940-41	9,645	131	0.1	9,240	Mar 04	235
1941-42	1,603	16	0.2	1,855	Dec 10	29
1942-43	9,271	573	0.5	9,095	Jan 23	1,700
1943-44	5,348	398	0.1	5,423	Feb 22	785
1944-45	3,747	97	0.9	3,811	Nov 11	375
1945-46	2,560	149	0.1	2,368	Dec 23	519
1946-47	2,705	100	0.1	2,982	Nov 20	340
1947-48	720	10	0	706	Feb 05	15
1948-49	728	11	0.1	694	Jan 20	19
1949-50	734	25	0.1	750	Dec 18	65
1950-51	300	5	0.1	301	Apr 29	16
1951-52	4,864	208	0.1	4,593	Jan 16	453
1952-53	822	10	0.1	1,092	Dec 01	25
1953-54	1,514	97	0.1	1,501	Jan 25	327
1954-55	561	11	0.1	526	Jan 18	27
1955-56	736	98	0.1	767	Jan 26	362
1956-57	452	12	0.1	433	Jan 13	41
1957-58	6,786	299	0	6,503	Apr 03	753
1958-59	931	37	0.1	1,239	Feb 16	189
1959-60	408	7	0.1	455	Feb 08	11
1960-61	468	31	0.1	250	Nov 05	397
1961-62	3,206	224	+	2,664	Nov 20	2,520
1962-63	1,001	81	0.1	1,108	Feb 09	440
1963-64	680	20	0.1	711	Jan 22	121
1964-65	1,118	53	0	1,175	Apr 09	232

N.D. Not determined

R.I. Records incomplete

+ Less than 0.05 acre feet or less than 0.05 cfs, but greater than 0

RESERVOIRS - YEARLY RESERVOIR OPERATION SUMMARY

San Dimas Dam

Season	Inflow Annual (AF)	Daily Mean Inflow		Outflow Annual (AF)	Peak Inflow	
		Max-Day (CFS)	Min-Day (CFS)		Date	Q (CFS)
1965-66	6,494	305	0.2	6,326	Dec 29	1,010
1966-67	12,352	674	0	11,598	Dec 06	1,720
1967-68	3,148	80	0.1	3,058	Nov 19	414
1968-69	28,645	1,710	0.7	28,808	Jan 25	3,620
1969-70	4,314	71	0.7	4,736	Mar 01	114
1970-71	2,465	70	0.5	2,125	Nov 29	127
1971-72	1,040	33	0.2	1,217	Dec 24	77
1972-73	4,252	346	0.7	4,000	Feb 11	685
1973-74	2,447	121	0.3	2,389	Jan 07	185
1974-75	1,487	28	0.1	1,566	Mar 06	67
1975-76	1,002	52	0.1	926	Sep 10	443
1976-77	1,094	41	0	1,146	Jan 03	260
1977-78	R.I.					
1978-79	R.I.					
1979-80	19,951	673	2.3	18,715	Feb 16	2,549
1980-81	3,016	37	0.8	3,216	Jan 29	147
1981-82	3,848	161	0.2	3,700	Mar 17	295
1982-83	17,632	527	0	17,381	Mar 01	1,559
1983-84	3,816	55	0	4,330	Dec 25	115
1984-85	2,554	45	0.6	2,560	Dec 19	67
1985-86	2,401	55	0	2,415	Mar 16	89
1986-87	N.D.	10	0.1	N.D.	Jan 05	13
1987-88	1,821	54	0	1,216	Jan 17	157
1988-89	1,122	35	0	1,225	Feb 04	96
1989-90	731	28	0	462	Feb 17	93
1990-91	1,967	112	0	2,361	Mar 27	236
1991-92	4,037	143	0	3,938	Feb 12	403
1992-93	24,941	651	0	24,446	Jan 14	945
1993-94	2,295	17	0.2	2,424	Feb 07	31
1994-95	10,102	177	0.8	9,801	Jan 10	363
1995-96	4,036	149	0.2	4,097	Feb 20	418
1996-97	13,175	81	0	2,988		N.D.
1997-98	12,122	396	0.3	11,948	Feb 23	1,194
1998-99						N.D.
1999-00	1,400	26	0	1,400	Feb 18	290
2000-01	1,610	55	0	1,570	Feb 13	80
2001-02	519	7	0	465	Jan 28	26

N.D. Not determined

R.I. Records incomplete

+ Less than 0.05 acre feet or less than 0.05 cfs, but greater than 0

RESERVOIRS - YEARLY RESERVOIR OPERATION SUMMARY

San Dimas Dam

Season	Inflow Annual (AF)	Daily Mean Inflow		Outflow Annual (AF)	Peak Inflow	
		Max-Day (CFS)	Min-Day (CFS)		Date	Q (CFS)
2002-03	3,180	174	0	2,370	Feb 13	1,240
2003-04	1,890	190	0	1,610	Dec 25	1,560
2004-05	24,650	1,160	0	23,740	Jan 09	1,680
2005-06	6,110	162	0	5,270	Apr 05	257
2006-07	1,730	10	0	1,560	Feb 27	14
2007-08	4,670	98	0	5,380	Apr 21	107
2008-09	4,270	60	1	4,130	Feb 07	83
2009-10	4,950	70	0	5,710	Jan 21	145
2010-11	9,150	228	0.6	8,630	Dec 22	392
2011-12	1,550	15	0	1,510	Apr 09	30
2012-13	753	6	0	658	Dec 26	78
2013-14	515	14	0	486	Feb 28	25
2014-15	378	5.2	0	350	Dec 12	10

N.D. Not determined

R.I. Records incomplete

+ Less than 0.05 acre feet or less than 0.05 cfs, but greater than 0

RESERVOIRS - YEARLY RESERVOIR OPERATION SUMMARY

San Gabriel Dam

Season	Inflow Annual (AF)	Daily Mean Inflow		Outflow Annual (AF)	Peak Inflow	
		Max-Day (CFS)	Min-Day (CFS)		Date	Q (CFS)
1937-38	339,155	30,720	37	332,893	Mar 02	89,320
1938-39	67,231	1,330	23	61,655	Dec 19	2,780
1939-40	58,554	757	18	63,386	Jan 08	2,270
1940-41	306,801	3,940	20	305,515	Feb 20	5,780
1941-42	50,285	297	20	49,759	Dec 29	468
1942-43	271,286	17,180	20	267,085	Jan 23	46,000
1943-44	184,923	5,710	43	184,622	Feb 22	9,860
1944-45	91,961	1,300	28	90,131	Nov 11	6,440
1945-46	99,531	2,980	28	89,502	Dec 21	5,760
1946-47	107,688	3,340	18	104,088	Dec 26	6,520
1947-48	29,259	257	9.9	37,794	Apr 29	506
1948-49	24,728	94	11	21,546	Jan 20	120
1949-50	27,797	266	9.5	27,736	Dec 19	448
1950-51	10,169	54	3	13,002	Jan 11	174
1951-52	159,048	3,340	3.9	118,918	Jan 16	6,130
1952-53	41,270	375	7.5	77,961	Dec 01	544
1953-54	60,515	1,280	8.3	56,517	Jan 25	2,940
1954-55	39,159	171	18	37,304	Apr 30	313
1955-56	35,215	950	14	38,127	Jan 26	2,250
1956-57	37,210	1,090	15	35,069	Jan 13	2,850
1957-58	230,745	4,270	21	229,610	Apr 03	6,900
1958-59	43,762	1,030	14	43,100	Jan 06	3,080
1959-60	19,474	112	5	19,258	Apr 28	168
1960-61	12,041	122	2.2	12,698	Nov 05	634
1961-62	116,890	6,350	3.4	112,380	Feb 11	13,960
1962-63	25,930	512	6.2	24,587	Feb 09	2,440
1963-64	24,009	287	5.2	22,601	Apr 01	504
1964-65	36,281	396	5.5	34,427	Apr 09	1,070
1965-66	220,689	9,030	12	217,503	Dec 29	27,180
1966-67	224,903	6,700	30	224,538	Dec 06	12,420
1967-68	66,761	697	26	68,771	Nov 19	1,620
1968-69	527,883	28,020	24	524,874	Jan 25	44,400
1969-70	66,842	1,250	26	66,688	Feb 28	2,550
1970-71	60,375	2,120	29	55,358	Nov 29	6,400
1971-72	34,908	975	14	38,192	Dec 25	1,390
1972-73	124,722	5,075	14.1	124,333	Feb 11	17,430
1973-74	72,959	1,140	32	67,194	Jan 07	1,820

N.D. Not determined

R.I. Records incomplete

+ Less than 0.05 acre feet or less than 0.05 cfs, but greater than 0

RESERVOIRS - YEARLY RESERVOIR OPERATION SUMMARY

San Gabriel Dam

Season	Inflow Annual (AF)	Daily Mean Inflow		Outflow Annual (AF)	Peak Inflow	
		Max-Day (CFS)	Min-Day (CFS)		Date	Q (CFS)
1974-75	47,681	423	27	46,194	Mar 06	880
1975-76	38,598	978	18	33,781	Sep 11	1,630
1976-77	36,322	407	15	34,846	Jan 03	1,137
1977-78	486,296	13,437	14.9	483,712	Mar 04	31,730
1978-79	158,043	1,647	42.9	163,511	Mar 28	1,965
1979-80	346,155	11,476	42.5	344,454	Feb 16	24,540
1980-81	42,882	281	15	40,116	Jan 29	784
1981-82	95,225	1,591	19	79,833	Mar 17	2,869
1982-83	404,332	14,585	33	402,734	Mar 01	17,080
1983-84	61,069	983	13	75,284	Dec 25	1,568
1984-85	46,633	617	8.5	46,101	Dec 19	742
1985-86	103,558	1,252	14	100,926	Jan 30	1,911
1986-87	22,847	149	3	22,919	Jan 05	259
1987-88	66,101	574	3.8	49,337	Feb 01	814
1988-89	33,435	273	4	47,683	Dec 16	496
1989-90	18,979	248	2.3	17,008	Feb 18	388
1990-91	61,479	1,575	3.3	39,454	Mar 01	4,294
1991-92	171,617	5,796	0	193,158	Feb 12	11,426
1992-93	445,072	10,181	0	429,615	Feb 19	12,934
1993-94	44,269	312	0.6	50,441	Feb 08	433
1994-95	248,268	3,811	12.8	242,886	Jan 10	6,996
1995-96	72,722	2,995	2	70,533	Feb 21	3,822
1996-97	66,570	946	3.6	65,430	Dec 22	1,200
1997-98	279,200	8,840	7.1	243,100	Feb 24	22,200
1998-99	108,000	1,320	14	82,660	Feb 25	17,800
1999-00	50,790	932	15.5	43,530	Feb 20	3,820
2000-01	59,390	721	13.7	59,740	Feb 13	1,360
2001-02	13,590	92	0	16,810	Jan 28	130
2002-03	55,900	1,140	0	48,710	Feb 13	2,170
2003-04	34,700	859	0	43,970	Feb 26	1,220
2004-05	541,000	19,600	11.5	534,000	Jan 11	24,700
2005-06	116,700	1,540	32	126,400	Apr 05	1,700
2006-07	17,370	53	0	17,480	Feb 27	56
2007-08	103,000	2,730	0	77,270	Feb 05	4,110
2008-09	53,010	488	1	45,650	Feb 06	653
2009-10	117,300	1,300	11.5	110,300	Feb 07	3,080
2010-11	208,600	5,870	54	199,000	Dec 20	10,700

N.D. Not determined

R.I. Records incomplete

+ Less than 0.05 acre feet or less than 0.05 cfs, but greater than 0

RESERVOIRS - YEARLY RESERVOIR OPERATION SUMMARY

San Gabriel Dam

Season	Inflow Annual (AF)	Daily Mean Inflow		Outflow Annual (AF)	Peak Inflow	
		Max-Day (CFS)	Min-Day (CFS)		Date	Q (CFS)
2011-12	43,430	200	16	56,060	Mar 17	625
2012-13	15,040	168	0.02	12,690	Dec 27	403
2013-14	16,830	904	3	22,480	Feb 28	2,170
2014-15	19,050	197	3.7	11,060	Sep 09	507

N.D. Not determined

R.I. Records incomplete

+ Less than 0.05 acre feet or less than 0.05 cfs, but greater than 0

RESERVOIRS - YEARLY RESERVOIR OPERATION SUMMARY

Santa Anita Dam

Season	Inflow Annual (AF)	Daily Mean Inflow		Outflow Annual (AF)	Peak Inflow	
		Max-Day (CFS)	Min-Day (CFS)		Date	Q (CFS)
1926-27	1,208	13	0.4	1,030		N.D.
1927-28	1,009	22	0.1	1,162		N.D.
1928-29	1,214	30	0	1,256		N.D.
1929-30	1,276	25	0.1	964		N.D.
1930-31	989	34	0	1,155		N.D.
1931-32	4,010	236	0.1	3,883		N.D.
1932-33	2,190	152	0	2,022	Jan 19	390
1933-34	2,603	322	0	2,622	Jan 01	800
1934-35	3,693	92	0.1	3,585	Apr 08	449
1935-36	2,480	84	0	2,535	Feb 12	228
1936-37	8,798	192	0	8,616	Feb 06	313
1937-38	16,594	1,780	1.3	16,689	Mar 02	5,140
1938-39	2,726	74	0.4	2,461	Dec 19	159
1939-40	2,743	62	0.4	2,664	Jan 08	378
1940-41	15,225	239	0.4	15,235	Mar 04	300
1941-42	2,070	25	0.6	2,140	Dec 29	53
1942-43	19,371	1,110	0.6	19,440	Jan 23	3,100
1943-44	7,463	514	1.3	7,294	Feb 22	813
1944-45	4,147	101	1.1	4,133	Nov 11	303
1945-46	3,426	164	0.8	3,360	Dec 23	492
1946-47	4,489	122	0.7	4,462	Nov 20	382
1947-48	1,075	14	0.3	1,243	Apr 28	41
1948-49	1,031	17	0.2	983	Jan 20	32
1949-50	1,357	30	0.2	1,311	Dec 18	115
1950-51	460	5	0.1	497	Jan 11	10
1951-52	8,408	351	0.1	8,292	Jan 16	837
1952-53	1,562	20	0.5	1,729	Dec 01	153
1953-54	3,302	201	0.4	3,412	Jan 24	1,240
1954-55	1,432	18	0.3	1,437	Nov 11	173
1955-56	2,218	175	0.3	2,196	Jan 26	569
1956-57	1,535	36	0.5	1,431	Feb 23	122
1957-58	11,696	298	0.7	11,715	Apr 03	618
1958-59	2,183	66	0.6	2,033	Jan 06	622
1959-60	954	7	0.1	1,152	Feb 01	16
1960-61	527	12	0.1	407	Jan 26	65
1961-62	6,328	682	0.1	6,242	Feb 11	1,460
1962-63	1,628	56	0.7	1,848	Feb 09	368

N.D. Not determined

R.I. Records incomplete

+ Less than 0.05 acre feet or less than 0.05 cfs, but greater than 0

RESERVOIRS - YEARLY RESERVOIR OPERATION SUMMARY

Santa Anita Dam

Season	Inflow Annual (AF)	Daily Mean Inflow		Outflow Annual (AF)	Peak Inflow	
		Max-Day (CFS)	Min-Day (CFS)		Date	Q (CFS)
1963-64	1,219	32	+	1,144	Apr 01	53
1964-65	2,039	50	0	1,988	Apr 09	130
1965-66	13,102	600	0.4	12,933	Dec 29	1,920
1966-67	16,245	645	1.5	16,261	Dec 06	1,520
1967-68	3,376	56	0.1	3,579	Nov 19	165
1968-69	38,734	2,292	0.3	38,369	Jan 25	5,500
1969-70	2,859	85	1	2,859	Feb 28	208
1970-71	3,211	184	1	3,075	Nov 29	674
1971-72	1,316	36	0.5	1,249	Dec 24	99
1972-73	6,414	482	0.4	6,258	Feb 11	1,350
1973-74	4,660	174	1.2	4,546	Jan 07	280
1974-75	2,347	36	0.1	2,647	Mar 06	54
1975-76	1,580	52	0.2	1,469	Mar 01	101
1976-77	1,320	35	1	1,206	Jan 03	200
1977-78	R.I.					
1978-79	R.I.					
1979-80	R.I.					
1980-81	2,221	27	0.6	2,210	Jan 29	147
1981-82	3,714	127	0.6	3,652	Mar 17	213
1982-83	21,246	882	0	21,325	Mar 02	1,197
1983-84	3,603	57	0.3	3,586	Dec 25	142
1984-85	2,363	48	0	2,272	Dec 19	102
1985-86	4,735	77	0.4	4,612	Jan 30	89
1986-87	1,041	8	0	1,174	Jan 05	11
1987-88	2,490	37	0.1	2,488	Jan 17	87
1988-89	1,729	52	0	1,599	Feb 04	119
1989-90	737	30	0	740	Feb 17	117
1990-91	2,393	92	0	2,323	Mar 01	417
1991-92	9,339	390	0.2	9,292	Feb 11	863
1992-93	23,546	558	0.2	23,581	Jan 07	909
1993-94	1,475	15	0	1,565	Mar 24	19
1994-95	12,439	242	0.1	12,281	Jan 10	587
1995-96	4,494	274	0.1	4,535	Feb 21	481
1996-97	4,480	101	0	4,400	Dec 22	241
1997-98	14,690	772	0	14,540	Feb 23	2,880
1998-99	1,970	12	0	1,190	Feb 09	32
1999-00	2,270	57	0	2,060	Feb 21	180

N.D. Not determined

R.I. Records incomplete

+ Less than 0.05 acre feet or less than 0.05 cfs, but greater than 0

RESERVOIRS - YEARLY RESERVOIR OPERATION SUMMARY

Santa Anita Dam

Season	Inflow Annual (AF)	Daily Mean Inflow		Outflow Annual (AF)	Peak Inflow	
		Max-Day (CFS)	Min-Day (CFS)		Date	Q (CFS)
2000-01	2,180	49	0	2,130	Feb 13	96
2001-02	1,600	19	0	1,390	Jan 28	27
2002-03	2,240	59	0	2,310	Nov 10	230
2003-04	1,480	78	0	1,550	Feb 26	309
2004-05	27,000	1,320	0	26,820	Jan 09	1,490
2005-06	4,430	109	0	4,020	Jan 02	474
2006-07	1,300	9	0	1,240	Feb 15	40
2007-08	5,780	173	0	5,680	Jan 05	464
2008-09	3,000	37	1	2,930	Feb 21	143
2009-10	4,630	105	0	4,550	Feb 06	342
2010-11	8,900	230	1.3	8,910	Dec 20	875
2011-12	2,150	21	0	2,140	Mar 17	46
2012-13	701	6	0	560	Jan 24	37
2013-14	335	20	0	445	Feb 28	60
2014-15	439	10	0	448	Dec 12	23

N.D. Not determined

R.I. Records incomplete

+ Less than 0.05 acre feet or less than 0.05 cfs, but greater than 0

RESERVOIRS - YEARLY RESERVOIR OPERATION SUMMARY

Thompson Creek Dam

Season	Inflow Annual (AF)	Daily Mean Inflow		Outflow Annual (AF)	Peak Inflow	
		Max-Day (CFS)	Min-Day (CFS)		Date	Q (CFS)
1931-32	81	12	0	81	Feb 09	91
1932-33	0	0	0	0		N.D.
1933-34	N.D.	N.D.	N.D.	0		N.D.
1934-35	1	N.D.	N.D.	0		N.D.
1935-36	1	N.D.	N.D.	0		N.D.
1936-37	274	24	0	0		N.D.
1937-38	1,099	259	0	1,096	Mar 02	580
1938-39	21	1	0	0	Jan 30	1
1939-40	49	5	0	0	Jan 07	26
1940-41	640	46	0	3	Mar 04	97
1941-42	0	+	0	0	Dec 10	1
1942-43	767	121	0	334	Jan 23	270
1943-44	286	56	0	0	Feb 22	111
1944-45	149	18	0	0	Nov 12	132
1945-46	148	25	0	0	Dec 23	120
1946-47	88	16	0	0	Nov 20	47
1947-48	0	0	0	0		N.D.
1948-49	0	0	0	0		N.D.
1949-50	6	2	0	0	Dec 19	5
1950-51	0	0	0	0		N.D.
1951-52	314	30	0	34	Jan 16	70
1952-53	12	1	0	0	Dec 01	8
1953-54	194	19	0	0	Jan 25	172
1954-55	4	1	0	0	Jan 18	1
1955-56	58	25	0	0	Jan 26	117
1956-57	4	2	0	0	Jan 13	6
1957-58	389	34	0	219	Apr 03	67
1958-59	6	1	0	0	Feb 16	5
1959-60	2	0	0	0	Apr 28	5
1960-61	5	1	0	0	Nov 12	4
1961-62	101	9	0	0	Nov 20	190
1962-63	88	26	0	17	Feb 09	145
1963-64	23	4	0	0	Mar 22	20
1964-65	26	10	0	0	Apr 09	55
1965-66	258	34	0	0	Nov 23	140
1966-67	842	200	0	305	Dec 06	408
1967-68	167	7	0	0	Nov 19	18

N.D. Not determined

R.I. Records incomplete

+ Less than 0.05 acre feet or less than 0.05 cfs, but greater than 0

RESERVOIRS - YEARLY RESERVOIR OPERATION SUMMARY

Thompson Creek Dam

Season	Inflow Annual (AF)	Daily Mean Inflow		Outflow Annual (AF)	Peak Inflow	
		Max-Day (CFS)	Min-Day (CFS)		Date	Q (CFS)
1968-69	2,556	279	0	2,061	Jan 25	574
1969-70	54	5	0	2	Mar 01	13
1970-71	32	6	0	0	Dec 21	12
1971-72	6	1	0	0	Dec 27	3
1972-73	161	34	0	8	Feb 11	58
1973-74	37	10	0	37	Jan 07	29
1974-75	0	0	0	0		N.D.
1975-76	15	4	0	0	Feb 01	4
1976-77	37	7	0	0		N.D.
1977-78	R.I.					N.D.
1978-79	R.I.					N.D.
1979-80	R.I.					N.D.
1980-81	0	0	0	0		N.D.
1981-82	62	9	0	18	Mar 17	40
1982-83	1,118	114	0	583	Mar 01	377
1983-84	70	3	0	11	Dec 26	4
1984-85	0	0	0	0		N.D.
1985-86	58	10	0	58	Mar 16	27
1986-87	0	0	0	0		N.D.
1987-88	2	0	0	2	Jan 17	1
1988-89	2	0	0	2	Feb 04	1
1989-90	6	1	0	6	Feb 17	1
1990-91	76	17	0	34	Mar 27	20
1991-92	190	16	0	190	Mar 23	20
1992-93	1,267	57	0	1,202	Jan 18	166
1993-94	0	0	0	0	Mar 19	1
1994-95	330	35	0	330	Jan 10	82
1995-96	392	31	0	392	Feb 20	73
1996-97	48	11	0	50		N.D.
1997-98	526	98	0	525	Feb 23	299
1998-99						N.D.
1999-00	19	0	0	19		N.D.
2000-01	4	1	0	4	Feb 13	1
2001-02	25	1	0	24	Nov 20	1
2002-03	71	14	0	71	Mar 16	14
2003-04	217	33	0	51	Feb 26	193
2004-05	1,710	85	0	1,640	Feb 21	137

N.D. Not determined

R.I. Records incomplete

+ Less than 0.05 acre feet or less than 0.05 cfs, but greater than 0

RESERVOIRS - YEARLY RESERVOIR OPERATION SUMMARY

Thompson Creek Dam

Season	Inflow Annual (AF)	Daily Mean Inflow		Outflow Annual (AF)	Peak Inflow	
		Max-Day (CFS)	Min-Day (CFS)		Date	Q (CFS)
2005-06	213	25	0	0	Feb 28	79
2006-07	8	2	0	0	Feb 27	10
2007-08	129	19	0	84	Jan 05	148
2008-09	57	8	0	3	Feb 17	29
2009-10	107	14	0	9	Jan 18	77
2010-11	434	89	0	79	Dec 22	275
2011-12	50	4	0	0	Feb 15	50
2012-13	19	3	0	0	Dec 18	40
2013-14	14	2.2	0	0	Dec 19	18
2014-15	48	3.8	0	3.4	Dec 12	30

N.D. Not determined

R.I. Records incomplete

+ Less than 0.05 acre feet or less than 0.05 cfs, but greater than 0

APPENDIX F

HYDROLOGIC REPORT 2014 – 2015

EROSION CONTROL - LOCATION MAP

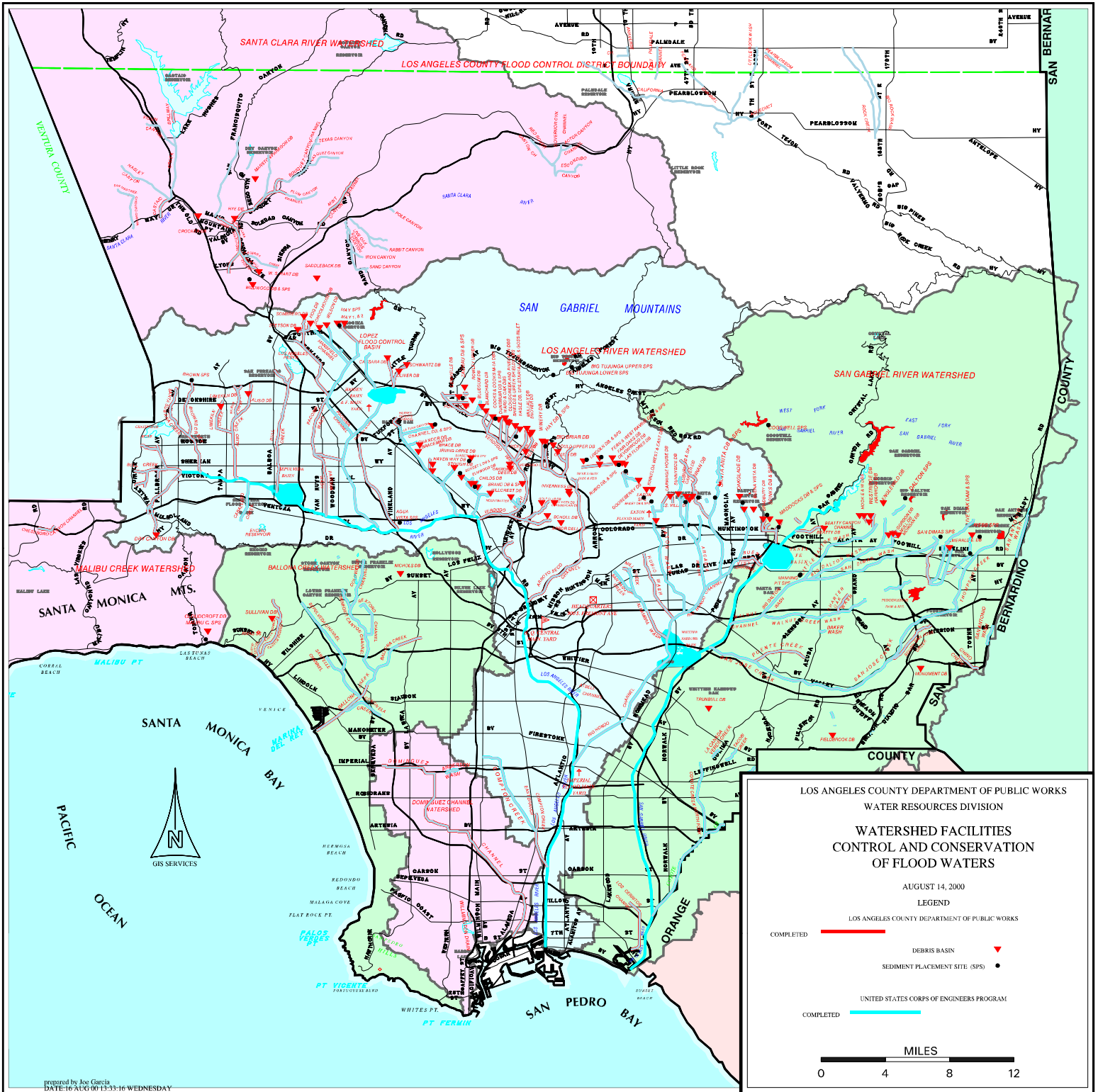

APPENDIX G

HYDROLOGIC REPORT 2014 – 2015

WATER CONSERVATION - SUMMARY - PUBLIC WORKS FACILITIES

WATER CONSERVATION - SUMMARY - PUBLIC WORKS FACILITIES

SPREADING FACILITY	TYPE	SEASON FIRST USED	AREA (ACRES)		CAPACITIES				LOCATION	WATER SOURCE(S)	REMARKS
			Gross	Wetted	CHANNEL* (cfs)	INTAKE (cfs)	STORAGE (acre*feet)	PERCOLATION** (cfs)			
BEN LOMOND	Medium Depth Basins	1958-59	24	17	9,000	400	168	30	North and south side of San Dimas Wash Channel at southwesterly corner of intersection of Arrow Highway and Barranca Avenue	Covina, Irrigation Company, uncontrolled runoff, imported water	Spreading grounds utilized to conserve excess Covina Irrigation Company water released from the Committee of Nine.
BIG DALTON	Shallow Basins	1930-31	24	2	5,000	45	8	15	Westerly side of Big Dalton Wash, 1/2 mile above Sierra Madre Ave.		
BRANFORD	Deep Basins	1956-57	12.2	7	1,540	1540	172	2	Soutwesterly of Arleta Ave. above confluence of Tujunga Wash and Pacoima Diversion Channel	Uncontrolled flows from Branford Street drain.	Instream spreading facility. Outlet capacity of 1,540 cfs to Pacoima Diversion Channel
BUENA VISTA	Deep Basins	1954-55	10	5	2,900	120	170	6	1 mile easterly of Sawpit Wash. 1/2 mile northerly of Arrow Highway between Meridian St. and Buena Vista Channel	Controlled flows from Santa Fe Dam and uncontrolled flow from Buena Vista Channel.	Instream spreading facility. Total outlet capacity of 270 cfs.
CITRUS	Medium Depth Basins	1960-61	19	15	11,000	45	82	28	South side of Big Dalton Wash between Citrus and Cerritos Ave.	Controlled flows from Big Dalton Dam and Little Dalton Debris Dams. Uncontrolled flows from Big Dalton Wash.	There are 2 intakes. One is a drop inlet; the other is an air inflated rubber dam.
DOMINGUEZ GAP	Deep & Shallow Basins	1957-58	54	24	146,000	20	234	1	South of Del Amo Blvd. and bordering the eastern and western sides of the L.A. River.	Controlled flows from the L.A. River low flow channel and uncontrolled flows from storm drains.	East side basin used for flood regulation with some water conservation storage. Intake capacity is 20 cfs for low flow diversion from the L.A. River. The west side basin is fed by a 42-inch siphon from the east side basin.
EATON BASIN	Deep Basins	1956-57	16	11	9,500	400	284	20	East side of Waton Wash, north of Duarte Rd, 0.6 miles south of Huntington Dr.	Controlled flows from Eaton Wash Dam and uncontrolled flows between dam and spreading basin.	

Footnotes: * Design capacity of main channel.
 ** The capacities listed are estimates of infiltration rates. Numbers do not reflect long term spreading operations.

WATER CONSERVATION - SUMMARY - PUBLIC WORKS FACILITIES

SPREADING FACILITY	TYPE	SEASON FIRST USED	AREA (ACRES)		CAPACITIES				LOCATION	WATER SOURCE(S)	REMARKS
			Gross	Wetted	CHANNEL* (cfs)	INTAKE (cfs)	STORAGE (acre*feet)	PERCOLATION** (cfs)			
EATON WASH	Deep & Shallow Basins	1947-48	25	23	6,600	200	577	14	Easterly side of Eaton Wash from below Eaton Dam to Foothill Blvd.	Controlled flows from Eaton Wash Dam. Imported water can be spread in strip basins.	
FORBES	Medium Depth Basins	1964-65	21	10	9,000	100	87	5	South side of San Dimas Wash between Lone Hill Ave. and Valley Center Ave.	Controlled releases from Puddingstone Diversion Dam and uncontrolled flows from San Dimas Wash; imported water.	
HANSEN	Medium Depth	1944-45	156	117	22,000	600	1409	150	Northwesterly side of Tujunga Wash from above Glenoaks, Blvd. Southwesterly to San Fernando Rd.	Controlled flows from Hansen Dam and Big Tujunga Dam.	
IRWINDALE & MANNING PIT	Deep Basins	1958-59	53	30	20,000	400	1,150	30	Northeasterly of intersection of Big Dalton Channel and Irwindale Ave; continues 1,300 feet east of Irwindale Ave.	Controlled flows from Big and Little Dalton Debris Dams and Puddingstone Diversion Dam via Big Dalton Channel; uncontrolled flows; imported releases.	
LITTLE DALTON	Shallow Basins	1931-32	14	5	8,600	20	25	12	Westerly of Glendora Mt. Rd. from Little Dalton Debris Basin south of East Palm Dr.	Controlled flows from Little Dalton Debris Basin and imported water. (Imported water delivery commenced in October 1995).	
LIVE OAK	Shallow Basins	1961-62	5	3	2,600	15	13	12	Westerly side of Live Oak Wash. North of Base Line Road (projected).	Controlled flows from Live Oak Dam and Live Oak Debris Basin. Imported water from TVMWD.	
LOPEZ	Shallow Basins	1956-57	18	12	11,000	25	25	15	Southeasterly side of Pacoima Wash, northeasterly of Foothill Blvd.	Controlled flows from Pacoima Dam and Lopez Flood Control Basin.	

Footnotes: * Design capacity of main channel.
 ** The capacities listed are estimates of infiltration rates. Numbers do not reflect long term spreading operations.

WATER CONSERVATION - SUMMARY - PUBLIC WORKS FACILITIES

SPREADING FACILITY	TYPE	SEASON FIRST USED	AREA (ACRES)		CAPACITIES				LOCATION	WATER SOURCE(S)	REMARKS
			Gross	Wetted	CHANNEL* (cfs)	INTAKE (cfs)	STORAGE (acre*feet)	PERCOLATION** (cfs)			
PACOIMA	Shallow	1932-33	169	107	17,000	600	537	65	Both sides of old Pacoima Wash Channel from Arleta Ave. southwesterly to Weoodman Ave.	Controlled flows from Pacoima Dam. Partially controlled flow from Lopez Flood Control basin, uncontrolled flow from East Canyon and Pacoima Wash; imported water.	
PECK ROAD	Deep	1959-60	157	105	30,100	30,100	3,157	25	Confluence of Sawpit and Santa Anita Washes.	Controlled releases from Santa Anita and Sawpit Debris basins and uncontrolled flows from local runoff via Sawpit and Santa Anita Washes.	Instream spreading facility.
RIO HONDO COASTAL	Medium Depth Basins	1937-38	570	389	40,000	1,950	3,694	400	Easterly side of Rio Hondo southerly from southern Pacific R.R. (south of Whittier Blvd.) to Slauson Ave.; west side of side of rio Hondo Channel 0.2 miles above whittier Blvd. South to Foster Bridge Blvd.	Controlled releases from San Gabriel Canyon Dams, Sante Fe, and whittier Narrows Dam. Uncontrolled runoff via San Gabriel River, Rio Hondo Channel, and their tributaries. Imported and reclaimed water.	In cooperation with the U.S. Army Corps of Engineers. Public Works operates 1,200 acre*foot pool at Whittier Narrows Dam for retention of storm water.
SAN GABRIEL RIVER (MONTEBELLO FOREBAY)	Medium Depth Basins	1954-55	308	153	20,000	In-river percolation	1,012	75	San Gabriel Spreading Grounds headworks to Firestone Ave. only. Storage behind the seven rubber dams intalled at each drop structure	Controlled releases from San Gabriel Canyon Dams, Santa Fe, and Whittier Narrows Dam. Imported and reclaimed water.	
SAN GABRIEL RIVER (SAN GABRIEL VALLEY)	Shallow	1965-66	196	196	41,000 - 98,000	In-river percolation	N/A	180	San Gabriel River from Santa Fe Dam to Whittier Narrows Dam.	Controlled flows from dams in the San Gabriel Canyon, Santa Fe Dam, and uncontrolled valley runoff below Santa fe Dam. Imported Water.	
SAN DIMAS CANYON	Shallow	1965-66	22	10	7,000	25	30	12	Southeast side of San Dimas Wash between Puddingstone Diversion and San Dimas Canyon Rd.	Controlled releases from Puddingstone Diversion Dam; uncontrolled flows from local storm runoff.	
SAN GABRIEL CANYON	Deep	1917-18	165	124	98,000	150	8,170	50	Easterly side of San Gabriel River. Below mouth of San Gabriel Canyon. North of the City of Azusa.	San Gabriel River controlled releases from Cogswell Dam, Sann Gabriel Dam, and Morris Dam. Committee of Nine surplus flows and imported water.	There are 2 intakes to this facility. One is fed from surplus Committee of Nine flows. The other is from the San Gabriel River into basin no. 2.

Footnotes: * Design capacity of main channel.
 ** The capacities listed are estimates of infiltration rates. Numbers do not reflect long term spreading operations.

WATER CONSERVATION - SUMMARY - PUBLIC WORKS FACILITIES

SPREADING FACILITY	TYPE	SEASON FIRST USED	AREA (ACRES)		CAPACITIES				LOCATION	WATER SOURCE(S)	REMARKS
			Gross	Wetted	CHANNEL* (cfs)	INTAKE (cfs)	STORAGE (acre*feet)	PERCOLATION** (cfs)			
SAN GABRIEL COASTAL	Medium Depth Basins	1938-39	128	96	20,000	350	1,712	75	Westerly side of San Gabriel River, southerly from Whittier Blvd. to Washington Blvd.	Controlled releases from San Gabriel Canyon Dams, Santa Fe, and Whittier Narrows Dam. Imported and reclaimed water.	
SANTA ANITA	Shallow	1944-45	15	13	12,000	20	50	5	Westerly side of Santa Anita Wash, 1.25 miles above Foothill Blvd.	Controlled flows from Santa Anita Dam and Santa Anita Debris Basin.	Santa Anita Headworks located upstream of the debris basin diverts water to Santa Anita Spreading Grounds and City of Sierra Madre Spreading Grounds.
SANTA FE	Shallow	1953-54	338	168	96,000	600	635	400	Within Santa Fe Dam reservoir and spillway areas.	Controlled flows from San Gabriel Canyon Reservoirs. Uncontrolled flows from San Gabriel River below Morris Reservoirs; imported water.	New diversion headworks structure constructed consisting of a new rubber dam and 2 intake gates.
SAWPIT	Shallow	1946-47	13	4	5,000	30	13	12	Westerly side of Sawpit Wash below mouth of canyon near Norumbega Drive, Monrovia.	Controlled flows from Sawpit Reservoir and Sawpit Debris Basin.	
VALLEY BOULEVARD RUBBER DAM	Shallow	1994-95	60	60	60,000	In-river percolation	900	0	Drop structure south of Valley Blvd. below the confluence of the San Gabriel River and Walnut Creek.	Controlled flows from Big and Little Dalton Debris Dams and Puddingstone Diversion Dam via Big Dalton Channel; uncontrolled flows; imported releases. May also receive releases from San Gabriel Canyon dams and imported water.	
WALNUT	Deep	1962-63	16	7	8,000	150	199	50	West side of Walnut Wash, north of San Bernardino Freeway.	Controlled flows from Puddingstone Reservoir and uncontrolled flows from Walnut Creek.	

Footnotes: * Design capacity of main channel.
 ** The capacities listed are estimates of infiltration rates. Numbers do not reflect long term spreading operations.

APPENDIX H

HYDROLOGIC REPORT 2014 – 2015

WATER CONSERVATION - SUMMARY - OTHER FACILITIES

WATER CONSERVATION - SUMMARY - OTHER FACILITIES

SPREADING FACILITY	TYPE	SEASON FIRST USED	AREA (ACRES)		CAPACITIES				LOCATION	WATER SOURCE(S)	REMARKS
			Gross	Wetted	CHANNEL* (cfs)	INTAKE (cfs)	STORAGE (acre*feet)	PERCOLATION** (cfs)			
FISH CANYON (COMMITTEE OF NINE)	Shallow	Circa 1917	6	4	N/A	N/A	N/A	7	Westerly side of San Gabriel River below mouth of Fish Canyon and north of the City of Azusa	The Committee of Nine	Owned and operated by Cal-American Water Company. Channel, intakes, and storage capacities are not available.
SIERRA MADRE (CITY OF SIERRA MADRE)	Shallow	Circa 1933	22	9	N/A	25	47	15	City of Sierra Madre, south side of Grandview Avenue, 1/2 mile west of Santa Anita Avenue	Little Santa Anita Creek and street runoff; also controlled flows from Santa Anita Dam.	Public Works diverts water to this facility via pipeline from Santa Anita Headworks. Channel capacity is not applicable.
THOMPSON CREEK (POMONA VALLEY PROTECTIVE ASSOCIATION)	Ditches, check basins, and deep basins.	Circa 1928	53	37	N/A	35	N/A	15	Southerly from and adjacent to Thompson Creek Dam, east side of Thompson Creek.	Cobal, Williams, Palmer, and Padua Creeks. Also Thompson Creek when reservoir is above elevation 1,625.	Operated by the Pomona Valley Protective Association. Public Works diverts water to this facility via the Palmer diversion.
TUJUNGA (L.A. CITY DEPT. OF WATER & POWER)	Shallow	Circa 1931	188	83	22,000	400	100	120	San Fernando Valley east side of Tujunga Wash at Roscoe Blvd.	Controlled releases from Big Tujunga Dam, Hansen Dam, and uncontrolled runoff from storm drains. Imported water.	Public Works has an agreement with the City of Los Angeles to operate this facility.

Footnotes:

* Design capacity of main channel.

** The capacities listed are estimates of infiltration rates. Numbers do not reflect long term spreading operations.

APPENDIX I

HYDROLOGIC REPORT 2014 – 2015

WATER CONSERVATION - SUMMARY - WATER CONSERVED

WATER CONSERVATION - SUMMARY - WATER CONSERVED

County of Los Angeles County Department of Public Works
 Total Monthly Water Conserved 2014-15
 (Acre-Feet)

AREA	SPREADING FACILITY	OCT	NOV	DEC	JAN	FEB	MAR	APR	MAY	JUN	JUL	AUG	SEP	ACC TOT	Historic Average	Historic High	
																Amount	Wtr Yr
San Fernando Valley Facilities	Branford	39	68	165	91	34	34	7	16	10	18	5	42	529	440	1,448	2004-05
	Hansen	0	0	413	148	99	75	39	61	9	78	0	0	922	10,616	35,221	1982-83
	Lopez	0	0	0	0	+	0	0	0	0	0	0	0	0	573	3,922	2010-11
	Pacoima	0	25	742	99	79	58	5	8	17	111	0	110	1,254	5,125	24,164	2010-11
	Tujunga [†]	0	0	194	0	0	40	26	2	0	6	0	0	268	8,133	42,817	1982-83
	Tujunga Wash *	29	32	35	32	32	30	31	47	31	40	35	40	414	6,592	39,602	2004-05
	SUBTOTAL1	68	125	1,549	370	244	237	108	134	67	253	40	192	3,387	31,479		
San Gabriel Valley Facilities	Ben Lomond	50	0	175	11	0	0	0	0	0	0	0	0	236	2,840	8,160	2004-05
	Big Dalton	0	0	0	0	0	0	0	1	0	0	0	0	1	625	3,766	1966-67
	Buena Vista	0	0	0	0	0	0	0	0	0	0	0	0	0	541	2,731	1957-58
	Citrus	0	1	246	54	50	24	12	39	19	27	46	64	582	1,010	6,478	1994-95
	Eaton Basin	20	39	317	51	61	28	14	40	10	33	25	50	688	1,063	3,481	1982-83
	Eaton Grounds	0	0	0	39	0	0	0	0	0	0	0	11	50	910	4,761	1982-83
	Forbes	0	0	0	0	0	0	0	0	0	0	0	0	0	713	2,628	1986-87
	Irwindale	0	94	71	3	0	0	0	40	0	40	0	84	332	5,537	41,280	1991-92
	Little Dalton	0	0	0	0	0	0	0	0	0	0	0	0	0	596	5,546	1995-96
	Live Oak	0	0	0	0	0	0	2	0	0	0	0	0	2	202	1,660	1982-83
	Peck Road	65	123	222	206	161	180	143	145	120	113	106	117	1,701	7,584	50,026	1982-83
	San Dimas Canyon	0	0	0	0	0	0	0	149	0	0	0	0	149	1,616	6,049	1982-83
	San Gabriel Canyon	2,370	1,810	1,350	1,440	1,360	2,000	2,090	1,310	1,230	2,380	2,750	2,530	22,620	15,696	33,577	2002-03
	Santa Anita	0	0	0	9	12	2	0	0	0	0	2	0	25	454	1,641	1965-66
	Santa Fe SG	0	0	0	0	0	0	0	0	0	0	0	0	0	26,464	124,478	1982-83
	Sawpit	0	0	0	0	0	6	14	32	17	7	6	2	84	729	2,926	1982-83
	Walnut	10	46	63	73	63	53	3	0	0	26	0	0	337	1,277	3,261	2004-05
	Sierra Madre [†]	0	0	83	10	41	73	3	0	0	0	97	0	307	1,609	5,003	1966-67
	Fish Canyon [†]	194	0	0	72	0	31	105	4	0	349	357	311	1,423	5,705	10,948	1978-79
	Between San Dimas Dam & S.G	8	+	1	7	4	5	7	114	18	15	0	0	179	305	431	2013-14
Between Big Dalton Dam & S.G	0	0	13	11	6	2	4	10	3	0	0	0	49	56	63	2013-14	
S.G. River Perc. Reach from Morris Dam to W.N. Dam	Morris Dam to Sta. F190	480	283	687	904	235	429	820	876	1,075	314	280	5,738	12,121	23,310	59,594	2004-05
	Sta. F190 to Santa Fe Dam O/F	1	4	148	7	15	5	7	11	143	24	4	26	395	16,454	119,600	1977-78
	Santa Fe Dam O/F to Sta. E322	662	1,776	1,977	955	1,916	2,017	670	660	987	1,657	723	823	14,823	25,812	103,347	2004-05
	E322 to F263	632	382	3,027	463	498	1,576	2,300	2,036	0	872	1,332	996	14,114	16,456	32,747	2009-10
	SUBTOTAL2	4,492	4,558	8,380	4,315	4,422	6,431	6,194	5,467	3,622	5,857	5,728	10,752	70,218	157,564		
Coastal Plain Facilities	Rio Hondo Coastal	0	49	6,400	271	467	168	1	318	0	45	0	253	7,972	33,538	96,324	1982-83
	Whittier Narrows Reservoir	819	1,500	4,778	1,255	1,603	1,024	426	1,119	103	680	251	3,251	16,809	27,943	102,610	1991-92
	San Gabriel Coastal	4,280	3,240	5,950	4,620	7,010	11,170	6,560	2,070	4,100	1,500	615	2,860	53,975	26,176	81,586	1992-93
	Dominguez Gap	31	30	1	0	10	0	0	0	0	0	0	24	96	575	2,414	1961-62
	SUBTOTAL3	5,130	4,819	17,129	6,146	9,090	12,362	6,987	3,507	4,203	2,225	866	6,388	78,852	88,232		
Total Water Conserved		9,690	9,502	27,058	10,831	13,756	19,030	13,289	9,108	7,892	8,335	6,634	17,332	152,457	277,275		

Note: † : Owned by other entities
 E: Estimated
 + : Less than one AF
 * : Reach from below Big Tujunga to Hansen Dam

APPENDIX J

HYDROLOGIC REPORT 2014 – 2015

WATER CONSERVATION - SUMMARY - IMPORTED WATER

WATER CONSERVATION - SUMMARY - IMPORTED WATER

IMPORTED WATER OUTLET RELEASES: *Water Delivered in Acre-Feet*

	Metropolitan Water District of Southern California							SGVMWD							San Fernando Valley-Burbank	Waste to the Ocean	MONTHLY TOTAL SPREAD	
	CENB - 48 *		Thomp. Creek	USG 3			TVMWD		S.G. Canyon		Beatty Canyon	Citrus	San Dimas					
	CENB	MSGB		CENB - 28 *	MSGB/Santa Fe	San. Gab. Cyn.	Co of 9 ¹	PM-26	Live Oak	Basin 1	MSGB		MSGB	CENB				MSGB
OCT	0	0	0	184.2	881	377.9	0	0	1,494	0	39	0	0	10	0	0	0	2,608.2
NOV	0	0	0	212.3	1,812	1604.6	0	0	0	0	0	0	0	0	0	0	0	2,024.3
DEC	0	0	0	371.4	1,350	1490.2	0	0	0	0	0	0	0	0	0	150	0	1,871.4
JAN	2,120.8	745.6	0	249.5	1,333	1154.4	0	0	0	0	0	0	0	0	0	0	0	4,448.9
FEB	4,627.9	1,627.3	0	0	1,364	1739	0	0	0	0	0	0	0	0	0	0	0	7,619.2
MAR	8,044.2	2,828.4	0	148.9	2,002.8	1485.7	0	0	0	0	0	0	0	0	0	0	0	13,024.3
APR	3,722.5	1,298.7	0	505	2,090	981	0	0	2	0	0	0	0	0	0	0	0	7,618.2
MAY	0	0	0	485.5	1,313	1831.9	0	0	5	0	0	0	0	0	0	0	0	1,803.5
JUN	0	0	0	386.1	1,230	1739	0	0	0	0	471	0	0	0	0	0	0	2,087.1
JUL	0	0	0	0	0	0	0	0	1,457	0	0	0	0	0	0	0	0	1,457
AUG	0	0	0	0	0	0	0	0	1,898	0	0	0	0	0	0	0	0	1,898
SEP	0	0	0	0	0	0	0	0	1,864	0	0	0	0	0	0	0	0	1,864
TOTAL	18,515.4	6,500	0	2,542.9	13,375.8	12,403.7	0	0	6,720	0	510	0	0	10	0	150	0	48,324.1

Notes: ¹ Import water utilized by Committee of Nine not included in total import water spread

APPENDIX K

HYDROLOGIC REPORT 2014 – 2015

WATER CONSERVATION - SUMMARY - RECLAIMED WATER

WATER CONSERVATION - SUMMARY - RECLAIMED WATER

RECLAIMED WATER OUTLET RELEASES: *Water Delivered in Acre-Feet*

	WHITTIER NARROWS PLANT				SAN JOSE CREEK PLANT				POMONA PLANT				MONTHLY	MONTHLY
	DELIVERED		Waste to	MONTHLY	DELIVERED		Waste to	MONTHLY	DELIVERED		Waste to	MONTHLY	TOTAL	TOTAL
	Rio Hondo	San Gabriel	the ocean	SPREAD	Rio Hondo	San Gabriel	the ocean	SPREAD	Rio Hondo	San Gabriel	the ocean	SPREAD	WASTED	SPREAD
OCT	632.3	0	0	632.3	0	4,454.7	0	4,454.7	0	195.2	0	195.2	0	5,282.2
NOV	684.1	0	0	684.1	0	3,388.1	0	3,388.1	0	319.3	0	319.3	0	4,391.5
DEC	761.5	0	26.6	734.9	0	3,118.2	0	3,118.2	0	672.5	0	672.5	26.6	4,525.6
JAN	738.8	0	0	738.8	0	2,828.9	0	2,829	0	589.5	0	589.5	0	4,157.2
FEB	645	0	0	645.0	0	2,897	0	2,897.0	0	319.2	0	319.2	0	3,861.2
MAR	436.6	0	0	436.6	0	1,950.1	0	1,950.1	0	152.7	0	152.7	0	2,539.4
APR	0.0	0	0	0	0	2,282.9	0	2,282.9	0	127.8	0	127.8	0	2,410.7
MAY	0.0	0	0	0.0	0	2,259	0	2,259.0	0	356.5	0	356.5	0	2,615.5
JUN	57.5	0	0	57.5	0	4,098.4	0	4,098.4	0	309.8	0	309.8	0	4,465.7
JUL	322.7	0	0	322.7	0	2,368.1	0	2,368.1	0	281.9	0	281.9	0	2,972.7
AUG	286.9	0	0	286.9	0	2,263.9	0	2,263.9	0	218.4	0	218.4	0	2,769.2
SEP	282.9	0.0	11.3	271.6	0	3,827.2	0	3,827.2	0	258.8	0	258.8	11.3	4,357.6
TOTAL	4,848.3	0	37.9	4,810.4	0	35,736.5	0	35,736.5	0	3,801.6	0	3,801.6	37.9	44,348.5

APPENDIX L

HYDROLOGIC REPORT 2014 – 2015

WATER CONSERVATION - SUMMARY - GROUND WATER

WATER CONSERVATION – WELL MEASUREMENT – GROUND WATER

Reading for well No. **460K**
 State Well No. **4S12W28H09**
 Latitude: **33-47-51**

Longitude: **118-08-17**

Thomas Guide Page: **796 A3**

WS_ELEV 1995-96	
10/13/1995	-31.60
11/18/1995	-19.40
12/18/1995	-25.40
1/22/1996	-18.60
2/21/1996	-10.30
3/20/1996	-11.60
4/22/1996	-5.80
5/23/1996	-37.40
6/21/1996	-51.80
7/22/1996	-62.60
8/23/1996	-64.80
9/23/1996	-78.90

WS_ELEV 1996-97	
10/23/1996	-70.40
11/23/1996	-70.40
12/23/1996	-70.40
1/23/1997	-8.10
2/18/1997	-6.40
3/18/1997	-7.80
4/22/1997	-44.40
5/18/1997	-74.40
6/18/1997	-93.20
7/22/1997	-98.80
8/21/1997	-101.20
9/20/1997	-103.40

WS_ELEV 1997-98	
10/21/1997	-57.10
11/14/1997	-45.20
12/19/1997	-29.10
1/14/1998	-20.20
2/16/1998	-24.40
3/19/1998	-11.80
4/14/1998	-8.10
5/17/1998	-58.50
6/16/1998	-86.10
7/15/1998	-95.60
8/24/1998	-111.50
9/24/1998	-113.30

WS_ELEV 1998-99	
10/16/1998	-61.30
11/16/1998	-42.20
12/13/1998	-21.80
1/23/1999	-22.90
2/17/1999	-32.20
3/22/1999	-14.50
4/19/1999	-15.40
5/18/1999	-70.40
6/18/1999	-88.40
7/22/1999	-96.40
9/24/1999	-107.40

WS_ELEV 1999-00	
10/24/1999	-48.90
11/22/1999	-35.90
1/19/2000	-29.30
2/24/2000	-28.00
3/22/2000	-19.90
4/21/2000	-25.00
5/1/2000	-81.20
6/20/2000	-97.90
7/17/2000	-102.70
8/22/2000	-109.00
9/23/2000	-109.40

WS_ELEV 2000-01	
10/23/2000	-63.60
11/23/2000	-45.20
12/23/2000	-41.60
1/20/2001	-38.40
2/20/2001	-31.90
3/23/2001	-30.30
4/15/2001	-22.80
5/24/2001	-85.20
6/20/2001	-98.50
7/22/2001	-104.90
8/23/2001	-107.90
9/24/2001	-110.30

WS_ELEV 2001-02	
10/20/2001	-70.40
11/19/2001	-48.40
1/20/2002	-40.80
2/22/2002	-44.10
3/21/2002	-27.20
4/18/2002	-22.00
5/23/2002	-90.00
6/22/2002	-120.50
7/24/2002	-107.40
8/18/2002	-108.90
9/12/2002	-109.90

WS_ELEV 2002-03	
10/22/2002	-70.40
11/20/2002	-51.00
12/1/2002	-40.80
1/22/2003	-38.30
2/20/2003	-37.70
3/17/2003	-30.90
4/18/2003	-45.90
5/23/2003	-88.10
6/23/2003	-73.70
7/18/2003	-68.20
8/20/2003	-57.50
9/24/2003	-71.40

WS_ELEV 2003-04	
10/22/2003	-49.70
11/22/2003	-50.40
12/10/2003	-38.40
1/22/2004	-41.40
2/23/2004	-31.20
3/22/2004	-24.40
4/17/2004	-23.10
5/22/2004	-48.60
6/20/2004	-67.50
7/20/2004	-95.40
8/17/2004	-102.20
9/21/2004	-105.90

WS_ELEV 2004-05	
10/20/2004	-61.40
11/18/2004	-48.00
12/23/2004	-53.40
1/17/2005	-33.20
2/24/2005	-26.90
3/23/2005	-21.30
4/23/2005	-21.40
5/23/2005	-39.40
6/15/2005	-38.50
7/17/2005	-69.30
8/23/2005	-66.90
9/22/2005	-74.40

WS_ELEV 2005-06	
10/22/2005	-37.40
11/21/2005	-30.90
12/15/2005	-28.40
1/22/2006	-14.40
2/22/2006	-13.30
3/22/2006	-13.40
4/23/2006	-8.30
5/23/2006	-53.80
6/18/2006	-73.20
7/23/2006	-70.80
8/22/2006	-81.20
9/23/2006	-93.50

WS_ELEV 2006-07	
10/23/2006	-40.70
11/18/2006	-28.70
12/20/2006	-21.50
1/18/2007	-19.30
2/24/2007	-15.90
3/17/2007	-13.40
4/16/2007	-13.20
5/22/2007	-41.30
6/16/2007	-83.50
7/17/2007	-106.90
8/22/2007	-101.90
9/22/2007	-103.70

WATER CONSERVATION – WELL MEASUREMENT – GROUND WATER

Reading for well No. **460K**
 State Well No. **4S12W28H09**
 Latitude: **33-47-51**

Longitude: **118-08-17**

Thomas Guide Page: **796 A3**

WS_ELEV 2007-08	
10/24/2007	-108.90
11/18/2007	-102.40
12/17/2007	-97.40
01/21/2008	-87.50
02/24/2008	-77.00
03/23/2008	-68.80
04/22/2008	-40.40
05/24/2008	-67.90
06/16/2008	-77.80
07/18/2008	-90.20
8/21/2008	-103.9
9/24/2008	-90.2

WS_ELEV 2008-09	
10/19/2008	-89
11/21/2008	-91.9
12/23/2008	-84.5
01/22/2009	-91.6
02/21/2009	-85.7
03/24/2009	-89.3
04/17/2009	-95.3
05/22/2009	-100.6
06/22/2009	-91.3
07/22/2009	-90.2
8/19/2009	-100.1
9/15/2009	-99.9

WS_ELEV 2009-10	
10/18/2009	-57.6
11/20/2009	-83.4
12/20/2009	-94.9
1/14/2010	-102.4
2/14/2010	-97.9
3/14/2010	-97.7
4/22/2010	-104.5
5/15/2010	105.5
6/15/2010	-104.7
8/16/2010	-101.4
9/19/2010	-107.50

WS_ELEV 2010-11	
10/20/2010	-106.9
11/18/2010	-109.3
12/23/2010	-54.2
1/20/2011	-56.2
2/23/2011	-80.9
3/18/2011	-86.4
4/19/2011	-55.7
5/20/2011	-43.6
7/14/2011	-39.1
8/14/2011	-29.50
9/13/2011	-28.30

WS_ELEV 2011-12	
10/22/2011	-16.3
11/13/2011	-36.7
12/18/2011	-53
1/13/2012	-75
2/19/2012	-79.9
3/17/2012	-78.6
4/20/2012	-76.2
5/14/2012	-77.7
6/17/2012	-84.1
7/10/2012	-79.6
8/24/2012	-93.7
9/21/2012	-89.6

WS_ELEV 2012-13	
10/25/2012	-45.5
11/11/2012	-39
12/10/2012	-34.7
1/13/2013	-38.5
2/18/2013	-42.6
3/14/2013	-46
4/14/2013	-50.7
5/12/2013	-54.9
6/18/2013	-58.2
7/21/2013	-60.3
8/26/2013	-62.1
9/22/2013	-61.9

WS_ELEV 2013-14	
10/13/2013	-66.4
11/14/2013	-41.8
12/15/2013	-43.4
1/12/2014	-75.5
2/21/2014	-97.5
3/15/2014	-98.4
4/13/2014	-100.4
5/14/2014	-102.6
6/17/2014	-100.3
7/25/2014	-102.5
8/19/2014	-109.2
9/18/2014	-111.2

WS_ELEV 2014-15	
10/16/2014	-109.9
11/19/2014	-105.2
12/16/2014	-75.3
1/20/2015	-51.6
2/9/2015	-47.3
3/17/2015	-35.4
4/18/2015	-28.8
5/19/2015	-67.7
6/14/2015	-78.3
7/14/2015	-83.3
08/19/2015	-93.3
9/22/2015	-96.6

WATER CONSERVATION – WELL MEASUREMENT – GROUND WATER

Reading for well No. **906D**
 State Well No. **4S13W12K01**
 Latitude: **33-50-10**

Longitude: **118-11-35**

Thomas Guide Page: **765 D5**

WS_ELEV 1995-96	
10/13/1995	-31.40
11/18/1995	-19.50
12/18/1995	-12.70
1/22/1996	-8.90
2/21/1996	-6.10
3/20/1996	-0.70
4/23/1996	2.50
5/23/1996	-7.10
6/21/1996	-19.70
7/22/1996	-30.80
8/23/1996	-41.00
9/23/1996	-49.00

WS_ELEV 1996-97	
10/31/1996	-10.90
11/23/1996	-22.20
12/23/1996	-48.20
1/23/1997	-5.40
2/18/1997	-1.40
3/18/1997	3.20
4/22/1997	-8.90
5/18/1997	-33.20
6/18/1997	-52.00
7/22/1997	-66.20
8/21/1997	-73.70
9/20/1997	-80.70

WS_ELEV 1997-98	
10/22/1997	-1.30
11/14/1997	-53.50
12/19/1997	-36.50
1/14/1998	-28.00
2/16/1998	-19.20
3/19/1998	-11.40
4/14/1998	-6.50
5/17/1998	-15.20
6/16/1998	-45.80
7/15/1998	-56.50
8/24/1998	-71.00
9/24/1998	-74.60

WS_ELEV 1998-99	
10/16/1998	-67.40
11/16/1998	-50.70
12/13/1998	-30.20
2/17/1999	-17.20
3/22/1999	-11.20
4/28/1999	-7.00
5/18/1999	-20.70
6/18/1999	-43.20
7/22/1999	-63.70
9/24/1999	-80.80

WS_ELEV 1999-00	
10/24/1999	-58.20
11/22/1999	-43.50
12/17/1999	-38.70
1/19/2000	-30.30
2/24/2000	-5.40
3/22/2000	-16.00
4/21/2000	-11.20
5/20/2000	-29.40
6/20/2000	-57.00
7/17/2000	-67.20
8/22/2000	-78.30
9/23/2000	-86.00

WS_ELEV 2000-01	
10/23/2000	-67.70
11/23/2000	-54.70
12/23/2000	-44.40
1/20/2001	-36.10
2/20/2001	-34.80
3/23/2001	-29.20
4/15/2001	-22.50
5/24/2001	-42.20
6/20/2001	-66.30
7/22/2001	-71.80
8/23/2001	-78.90
9/24/2001	-84.80

WS_ELEV 2001-02	
10/20/2001	-74.00
11/19/2001	-52.20
1/20/2002	-34.40
2/22/2002	-33.00
3/21/2002	-26.90
4/19/2002	-21.10
5/23/2002	-37.90
6/22/2002	-40.70
7/24/2002	-70.60
8/18/2002	-73.20
9/12/2002	-80.00

WS_ELEV 2002-03	
10/22/2002	-73.50
11/20/2002	-58.30
12/20/2002	-48.40
1/22/2003	-37.50
2/20/2003	-35.40
3/17/2003	-29.60
4/18/2003	-26.80
5/23/2003	-41.20
6/23/2003	-50.00
7/18/2003	-54.00
8/20/2003	-53.20
9/24/2003	-53.10

WS_ELEV 2003-04	
10/22/2003	-41.40
11/22/2003	-39.20
12/10/2003	-39.40
1/22/2004	-37.30
2/23/2004	-32.00
3/22/2004	-25.50
4/17/2004	-19.50
5/22/2004	-23.10
6/20/2004	-29.20
7/20/2004	-49.00
8/17/2004	-59.00
9/21/2004	-68.20

WS_ELEV 2004-05	
10/20/2004	-65.50
11/18/2004	-49.50
1/17/2005	-36.00
2/24/2005	-26.40
3/23/2005	-50.70
4/23/2005	-64.20
5/23/2005	-15.70
6/15/2005	-18.70
7/17/2005	-28.40
8/23/2005	-41.20
9/22/2005	-41.30

WS_ELEV 2005-06	
10/22/2005	-35.30
11/21/2005	-27.60
12/15/2005	-21.90
1/22/2006	-13.40
2/22/2006	-12.00
3/22/2006	-6.10
4/23/2006	-2.20
5/23/2006	-9.70
6/18/2006	-24.10
7/23/2006	-35.90
8/22/2006	-40.20
9/23/2006	-47.80

WS_ELEV 2006-07	
10/23/2006	-40.20
11/18/2006	-30.10
12/20/2006	-20.50
1/18/2007	-12.30
2/24/2007	-38.20
3/17/2007	-38.20
4/16/2007	0.40
5/22/2007	-7.70
6/16/2007	-23.70
7/17/2007	-43.40
8/22/2007	-57.10
9/22/2007	-62.60

WATER CONSERVATION – WELL MEASUREMENT – GROUND WATER

Reading for well No. **906D**
 State Well No. **4S13W12K01**
 Latitude: **33-50-10**

Longitude: **118-11-35**

Thomas Guide Page: **765 D5**

WS_ELEV 2007-08	
10/24/2007	-67.70
11/18/2007	-71.00
12/17/2007	-71.70
1/21/2008	-66.40
2/24/2008	-62.10
3/23/2008	-60.20
4/22/2008	-47.10
4/22/2008	-49.70
5/24/2008	-42.90
6/16/2008	-43.60
7/18/2008	-48.60
8/21/2008	-55.1
9/24/2008	-61.1

WS_ELEV 2008-09	
10/19/2008	-59.4
10/21/2008	-59.7
11/21/2008	-58.1
12/23/2008	-56.4
01/22/2009	-55.7
02/21/2009	-58.0
03/24/2009	-60.1
04/17/2009	-59.4
05/22/2009	-67.2
06/22/2009	-67.7
07/22/2009	-68.2
8/19/2009	-72.2
9/15/2009	-73

WS_ELEV 2009-10	
10/18/2009	-64.8
11/20/2009	-55.2
12/20/2009	-61.9
1/14/2010	-68.1
2/14/2010	-70.9
3/14/2010	-72
4/22/2010	-73
5/15/2010	-72.8
6/15/2010	-73.7
8/16/2010	-73.4
9/19/2010	-73.8

WS_ELEV 2010-11	
10/20/2010	-44.7
11/18/2010	-68.6
12/23/2010	-49.2
1/20/2011	-42.9
2/23/2011	-45.4
3/18/2011	-68.6
4/19/2011	-45.6
5/20/2011	-36.4
7/14/2011	-26.2
8/14/2011	-21
9/13/2011	-18.6

WS_ELEV 2011-12	
10/22/2011	-10.5
11/13/2011	-8.9
12/18/2011	-16.5
1/13/2012	-25.6
2/19/2012	-39.1
3/17/2012	-43.8
4/20/2012	-47.5
5/14/2012	-47.1
6/17/2012	-21.9
7/10/2012	-51
8/24/2012	-54.7
9/21/2012	-54.4

WS_ELEV 2012-13	
10/25/2012	-45.5
11/11/2012	-39
12/10/2012	-34.7
1/13/2013	-38.5
2/18/2013	-42.6
3/14/2013	-46
4/14/2013	-50.7
5/12/2013	-54.9
6/18/2013	-58.2
7/21/2013	-60.3
8/26/2013	-62.1
9/22/2013	-61.9

WS_ELEV 2013-14	
10/13/2013	-57.3
11/14/2013	-44.1
12/15/2013	-37.5
1/12/2014	-40.9
2/21/2014	-54.5
3/15/2014	-59.7
4/13/2014	-62.7
5/14/2014	-66
6/17/2014	-67.6
7/25/2014	-68.7
8/19/2014	-70.6
9/18/2014	-73.2

WS_ELEV 2014-15	
10/16/2014	-74.7
11/19/2014	-76.2
12/16/2014	-77.2
1/20/2015	-59
2/9/2015	-52.5
3/17/2015	-42.1
4/15/2015	-33.7
5/19/2015	-39.2
6/14/2015	
7/14/2015	-55.9
8/19/2015	-60
9/22/2015	-34.4

WATER CONSERVATION – WELL MEASUREMENT – GROUND WATER

Reading for well No. **1601T**
 State Well No. **2S12W24M08**
 Latitude: **33-58-49**

Longitude: **118-05-59**Thomas Guide Page: **676 E6**

WS_ELEV 1995-96	
10/27/1995	113.30
11/30/1995	113.40
12/29/1995	115.60
1/24/1996	118.10
2/29/1996	124.90
3/29/1996	128.40
4/25/1996	128.70
5/30/1996	125.10
6/28/1996	125.80
7/25/1996	123.80
8/31/1996	120.10
9/27/1996	119.50

WS_ELEV 1996-97	
10/24/1996	117.70
11/29/1996	117.50
12/27/1996	124.70
1/30/1997	129.40
2/28/1997	129.20
3/28/1997	125.30
4/25/1997	127.20
5/23/1997	126.70
6/27/1997	124.60
7/31/1997	124.60
8/28/1997	120.20
9/27/1997	116.20

WS_ELEV 1997-98	
10/31/1997	113.20
11/28/1997	112.10
12/24/1997	117.30
1/31/1998	122.30
2/28/1998	126.30
3/27/1998	128.20
4/30/1998	129.60
5/29/1998	127.70
6/26/1998	126.40
7/31/1998	124.90
8/28/1998	120.40
9/25/1998	117.30

WS_ELEV 1998-99	
10/30/1998	116.20
11/27/1998	115.90
12/31/1998	115.20
1/29/1999	115.20
2/26/1999	117.50
3/26/1999	118.00
4/30/1999	120.00
5/28/1999	116.50
6/25/1999	115.40
7/30/1999	108.60
8/27/1999	104.90
9/24/1999	100.90

WS_ELEV 1999-00	
10/29/1999	96.70
11/26/1999	96.10
12/31/1999	97.50
1/28/2000	103.70
2/25/2000	113.60
3/31/2000	119.80
4/21/2000	119.90
5/26/2000	119.40
6/30/2000	117.20
7/28/2000	113.50
8/18/2000	108.80

WS_ELEV 2000-01	
10/27/2000	104.40
11/24/2000	105.90
12/30/2000	109.40
1/26/2001	108.80
2/22/2001	111.70
3/23/2001	117.30
4/26/2001	117.40
5/25/2001	113.30
6/29/2001	109.00
7/27/2001	104.40
8/31/2001	99.00
9/28/2001	98.00

WS_ELEV 2001-02	
10/26/2001	96.60
11/23/2001	99.00
12/31/2001	100.00
1/25/2002	113.80
2/22/2002	112.40
3/29/2002	110.70
4/26/2002	109.50
5/31/2002	107.80
6/28/2002	106.10
7/26/2002	104.90
8/31/2002	99.20
9/27/2002	94.80

WS_ELEV 2002-03	
10/25/2002	92.80
11/22/2002	99.10
12/28/2002	111.10
1/31/2003	111.00
2/28/2003	114.90
3/26/2003	118.20
4/18/2003	117.90
5/30/2003	114.20
6/27/2003	107.70
7/25/2003	100.70
8/29/2003	93.40
9/26/2003	88.80

WS_ELEV 2003-04	
10/31/2003	85.80
11/28/2003	86.60
12/26/2003	87.30
1/30/2004	90.50
2/28/2004	97.90
3/26/2004	105.10
4/23/2004	101.50
5/29/2004	94.90
6/25/2004	90.30
7/30/2004	88.00
8/27/2004	83.70
9/18/2004	79.20

WS_ELEV 2004-05	
10/30/2004	85.90
11/26/2004	93.20
12/31/2004	103.50
1/29/2005	114.20
2/25/2005	117.20
3/25/2005	120.40
4/29/2005	121.60
5/14/2005	122.20
6/24/2005	120.10
7/29/2005	116.80
8/26/2005	111.80
9/30/2005	105.90

WS_ELEV 2005-06	
10/28/2005	102.90
11/26/2005	99.20
12/30/2005	97.70
1/27/2006	101.10
2/25/2006	102.50
3/31/2006	113.70
4/28/2006	119.30
5/27/2006	120.30
6/30/2006	117.00
7/28/2006	114.30
8/25/2006	113.90
9/30/2006	109.00

WS_ELEV 2006-07	
10/27/2006	106.70
11/25/2006	106.90
12/29/2006	109.30
1/26/2007	112.40
2/24/2007	110.70
3/28/2007	112.50
4/27/2007	115.30
5/25/2007	111.60
6/30/2007	105.30
7/28/2007	100.40
8/31/2007	94.90
9/28/2007	91.00

WATER CONSERVATION – WELL MEASUREMENT – GROUND WATER

Reading for well No. **1601T**State Well No. **2S12W24M08**Latitude: **33-58-49**Longitude: **118-05-59**Thomas Guide Page: **676 E6**

WS_ELEV 2007-08	
10/26/2007	87.40
11/3/2007	86.50
12/28/2007	89.20
1/26/2008	97.70
2/29/2008	107.70
3/28/2008	104.70
4/25/2008	99.80
5/31/2008	93.50
6/28/2008	88.80
7/25/2008	84.70
8/30/2008	82.3
9/26/2008	80.6

WS_ELEV 2008-09	
10/31/2008	77.7
11/28/2008	76.3
12/26/2008	82.0
1/30/2009	79.5
2/27/2009	94.00
3/27/2009	95.2
4/24/2009	87.80
5/29/2009	82.3
6/26/2009	78.1
7/31/2009	73.9
8/28/2009	72.30
9/25/2009	69.20

WS_ELEV 2009-10	
10/30/2009	67.2
11/27/2009	67.4
12/4/2009	74.7
1/30/2010	82.5
2/27/2010	98.4
3/26/2010	101.5
4/30/2010	105.4
5/28/2010	100.8
6/25/2010	94.7
08/27/10	80.8
9/24/2010	77.1

WS_ELEV 2010-11	
10/2/2010	76.2
11/6/2010	79.7
12/4/2010	90.5
1/8/2011	104.9
2/4/2011	106.6
3/4/2011	110.9
4/1/2011	115.3
5/6/2011	117.7
07/01/11	113.5
8/5/2011	108.5
9/2/2011	107.9

WS_ELEV 2011-12	
10/21/2011	104.3
11/18/2011	105.5
12/17/2011	105.2
1/21/2012	103.3
2/17/2012	102.3
3/17/2012	99.7
4/21/2012	104.6
5/18/2012	102.8
6/22/2012	98.8
7/20/2012	94.6
8/24/2012	89.1
9/21/2012	85.8

WS_ELEV 2012-13	
10/19/2012	83.3
11/16/2012	81.9
12/21/2012	84.1
1/18/2013	87
2/15/2013	88.1
3/22/2013	86.7
4/19/2013	85.4
5/17/2013	82.4
6/20/2013	80.1
7/19/2013	78.4
8/16/2013	75.5
9/20/2013	73.3

WS_ELEV 2013-14	
10/12/2013	71.2
11/15/2013	67.7
12/13/2013	66.8
1/17/2014	67.3
2/15/2014	65.6
3/14/2014	71.4
4/12/2014	70.6
5/16/2014	66.9
6/13/2014	65.2
7/11/2014	63.7
8/15/2014	62.3
9/12/2014	61.2

WS_ELEV 2014-15	
10/3/2014	59.8
11/14/2014	58.6
12/12/2014	59.5
1/16/2015	64.9
2/13/2015	64.6
3/13/2015	65.1
4/10/2015	67.5
5/15/2015	66.7
6/12/2015	64.5
7/17/2015	62.9
8/14/2015	59.6
9/18/2015	56.3

WATER CONSERVATION – WELL MEASUREMENT – GROUND WATER

Reading for well No. **3030F**

State Well No. **1S10W07R02**

Latitude: **34-05-34**

Longitude: **117-57-46**

Thomas Guide Page: **598 C4**

WS_ELEV 1995-96	
10/27/1995	257.80
11/30/1995	255.70
12/29/1995	253.90
1/24/1996	252.20
2/29/1996	250.40
3/29/1996	250.10
4/26/1996	248.80
5/30/1996	249.50
6/28/1996	248.50
7/25/1996	247.30
8/31/1996	248.10
9/27/1996	248.90

WS_ELEV 1996-97	
10/24/1996	248.70
11/29/1996	246.90
12/27/1996	228.90
1/23/1997	246.70
2/28/1997	251.30
3/28/1997	248.90
4/25/1997	246.20
5/23/1997	243.50
6/27/1997	240.50
7/31/1997	238.70
8/28/1997	239.70
9/27/1997	238.90

WS_ELEV 1997-98	
10/31/1997	238.60
11/28/1997	238.20
12/24/1997	239.90
1/31/1998	241.00
2/22/1998	241.60
3/27/1998	249.50
4/30/1998	255.90
5/29/1998	262.00
6/26/1998	267.60
7/31/1998	267.20
8/28/1998	265.40
9/25/1998	264.40

WS_ELEV 1998-99	
10/30/1998	261.80
11/27/1998	260.70
12/31/1998	258.80
1/29/1999	255.80
2/26/1999	253.90
3/26/1999	251.90
4/30/1999	250.30
5/28/1999	247.40
6/25/1999	245.30
7/30/1999	241.90
8/27/1999	240.00
9/24/1999	238.90

WS_ELEV 1999-00	
10/29/1999	236.80
11/26/1999	235.00
12/31/1999	232.90
1/28/2000	231.40
2/25/2000	231.00
3/31/2000	230.90
4/28/2000	230.50
5/26/2000	229.60
6/30/2000	228.10
7/28/2000	227.20
8/25/2000	225.20
9/29/2000	225.60

WS_ELEV 2000-01	
10/27/2000	227.10
11/27/2000	228.30
12/30/2000	228.80
1/26/2001	229.40
2/22/2001	227.40
3/23/2001	227.00
4/26/2001	225.40
5/25/2001	222.60
6/29/2001	219.90
7/27/2001	217.10
8/31/2001	216.90
9/28/2001	214.10

WS_ELEV 2001-02	
10/19/2001	215.20
11/23/2001	217.40
12/28/2001	218.40
1/25/2002	217.40
2/22/2002	216.30
3/29/2002	214.70
4/26/2002	213.40
5/31/2002	212.00
6/28/2002	210.60
7/26/2002	208.70
8/31/2002	207.00
9/27/2002	205.10

WS_ELEV 2002-03	
10/25/2002	204.00
11/22/2002	203.50
12/28/2002	204.00
1/31/2003	203.30
6/27/2003	203.80
7/25/2003	204.90
8/29/2003	203.70
9/26/2003	206.50

WS_ELEV 2003-04	
10/31/2003	210.10
11/29/2003	209.70
12/26/2003	209.40
1/30/2004	210.90
2/28/2004	212.50
3/26/2004	212.20
4/23/2004	211.30
5/22/2004	208.00
6/25/2004	204.90
7/30/2004	201.40
8/27/2004	199.20
9/24/2004	197.40

WS_ELEV 2004-05	
10/30/2004	196.10
11/26/2004	195.40
12/31/2004	195.80
1/29/2005	203.40
2/26/2005	222.00
3/25/2005	238.10
4/29/2005	245.00
5/14/2005	247.70
6/24/2005	249.60
7/29/2005	244.70
8/26/2005	241.90
9/30/2005	240.90

WS_ELEV 2005-06	
10/28/2005	241.10
11/26/2005	241.00
12/30/2005	242.10
1/27/2006	241.70
2/25/2006	241.50
3/31/2006	243.60
4/28/2006	246.80
5/27/2006	251.60
6/30/2006	250.70
7/28/2006	246.10
8/25/2006	243.20
9/30/2006	239.70

WS_ELEV 2006-07	
10/27/2006	237.90
11/25/2006	236.00
12/29/2006	234.40
1/26/2007	232.60
2/24/2007	230.90
3/28/2007	227.90
4/27/2007	226.00
5/25/2007	223.80
6/30/2007	220.70
7/28/2007	217.70
8/31/2007	214.70
9/28/2007	212.60

WATER CONSERVATION – WELL MEASUREMENT – GROUND WATER

Reading for well No. **3030F**

State Well No. **1S10W07R02**

Latitude: **34-05-34**

Longitude: **117-57-46**

Thomas Guide Page: **598 C4**

WS_ELEV 2007-08	
10/26/2007	211.30
11/3/2007	210.90
12/28/2007	209.00
1/26/2008	208.80
2/29/2008	208.80
3/28/2008	207.40
4/25/2008	206.10
5/31/2008	204.40
6/28/2008	202.70
7/25/2008	202.30

WS_ELEV 2008-09	
1/30/2009	200.4
2/27/2009	201
3/27/2009	200
4/24/2009	199
5/29/2009	196.9
6/26/2009	195.7
7/31/2009	193.4
8/28/2009	191.9
9/25/2009	190.4

WS_ELEV 2009-10	
10/30/2009	188.90
11/27/2009	189.40
12/24/2009	189.80
1/30/2010	190.70
2/27/2010	192.00
3/26/2010	192.30
4/30/2010	197.40
5/25/2010	201.90
6/18/2010	204.50
8/27/2010	206.10
9/24/2010	204.40

WS_ELEV 2010-11	
10/2/2010	205.30
11/6/2010	207.70
12/4/2010	209.00
1/8/2011	217.90
2/4/2011	224.50
3/4/2011	226.00
4/1/2011	228.50
5/6/2011	232.00
7/1/2011	234.10
8/5/2011	233.50
9/2/2011	235.30

WS_ELEV 2011-12	
10/21/2011	236.2
11/18/2011	236.8
12/17/2011	236.4
1/21/2012	233.9
2/17/2012	231.8
3/17/2012	229.5
4/21/2012	227.2
5/18/2012	224.8
6/22/2012	221.5
7/20/2012	218.6
8/24/2012	215.3
9/21/2012	213.1

WS_ELEV 2012-13	
10/19/2012	211.8
11/16/2012	213.2
12/21/2012	214.1
1/18/2013	213.6
2/15/2013	212.6
3/22/2013	211.3
4/19/2013	209.5
5/17/2013	206.8
6/20/2013	204.1
7/19/2013	201.6
8/16/2013	199.1
9/20/2013	196.9

WS_ELEV 2013-14	
10/12/2013	194.6
11/2/2013	194.9
12/13/2013	196.8
1/17/2014	196.8
2/15/2014	195.8
3/14/2014	194.5
4/12/2014	192.9
5/17/2014	190.1
6/14/2014	188.1
7/11/2014	186.1
8/15/2014	183.9
9/12/2014	182.4

WS_ELEV 2014-15	
10/3/2014	182.5
11/15/2014	180.9
12/12/2014	180.4
1/16/2015	180.9
2/13/2015	180.6
3/13/2015	180.2
4/10/2015	179.7
5/16/2015	178.9
6/13/2015	178.4
7/18/2015	177
8/15/2015	176.1
9/18/2015	175.1

WATER CONSERVATION – WELL MEASUREMENT – GROUND WATER

Reading for well No. **3872H**
 State Well No. **1N14W14F05**
 Latitude: **34-10-20**

Longitude: **118-19-18**

Thomas Guide Page: **563 F1**

WS_ELEV 1995-96	
10/23/1995	476.60
11/28/1995	485.60
12/19/1995	477.30
1/17/1996	476.70
2/28/1996	483.40
3/19/1996	484.10
4/22/1996	483.30
5/15/1996	477.20
6/12/1996	475.90
7/22/1996	474.90
8/20/1996	474.60
9/17/1996	473.40

WS_ELEV 1996-97	
10/28/1996	482.00
11/26/1996	475.40
12/30/1996	478.20
1/18/1997	483.10
3/12/1997	483.10
4/9/1997	483.20
5/7/1997	474.70
6/18/1997	477.60
8/12/1997	478.00
9/9/1997	471.10

WS_ELEV 1997-98	
12/16/1997	477.90
1/26/1998	478.60
2/25/1998	478.60
3/24/1998	479.80
4/20/1998	471.00
5/13/1998	470.70
6/10/1998	471.30
7/20/1998	472.90
8/18/1998	471.20
9/9/1998	475.20

WS_ELEV 1998-99	
10/21/1998	471.60
11/23/1998	471.60
12/28/1998	480.50
3/16/1999	480.00
4/26/1999	479.40
5/25/1999	472.90
6/15/1999	469.90
7/26/1999	466.20
8/17/1999	469.70
9/28/1999	463.10

WS_ELEV 1999-00	
12/21/1999	465.30
1/26/2000	468.60
2/15/2000	468.20
3/27/2000	467.90
5/23/2000	457.70
6/19/2000	456.50
8/16/2000	464.80

WS_ELEV 2000-01	
10/17/2000	455.50
11/14/2000	454.60
12/27/2000	454.90
1/30/2001	454.10
2/28/2001	454.50
3/27/2001	463.70
4/17/2001	458.80
6/11/2001	463.90
7/16/2001	463.70
8/13/2001	463.40
9/11/2001	462.70

WS_ELEV 2001-02	
10/15/2001	462.60
11/13/2001	462.40
12/26/2001	462.40
1/15/2002	462.90
2/13/2002	463.10
3/27/2002	462.90
4/15/2002	462.60
7/29/2002	461.40
9/25/2002	460.60

WS_ELEV 2002-03	
10/21/2002	460.40
12/20/2002	460.00
1/29/2003	459.50
6/25/2003	458.90
7/8/2003	458.80
8/18/2003	458.30
9/16/2003	457.80

WS_ELEV 2003-04	
10/22/2003	457.20
11/24/2003	456.80
12/24/2003	456.80
1/14/2004	456.30
2/18/2004	455.40
3/29/2004	455.70
4/27/2004	455.90
5/19/2004	455.30
7/21/2004	454.80
9/21/2004	453.30

WS_ELEV 2004-05	
10/13/2004	453.60
11/17/2004	452.80
12/20/2004	453.30
3/7/2005	454.10
4/25/2005	455.70
5/23/2005	454.80
6/15/2005	448.70
8/18/2005	458.70
9/21/2005	460.40

WS_ELEV 2005-06	
10/24/2005	461.00
11/22/2005	462.40
12/20/2005	462.40
1/17/2006	463.40
2/21/2006	464.00
4/4/2006	464.00
6/14/2006	465.90
7/24/2006	466.00
8/21/2006	466.10
9/14/2006	466.20

WS_ELEV 2006-07	
10/17/2006	465.70
11/20/2006	466.70
12/27/2006	466.10
1/23/2007	466.20
2/20/2007	468.10
3/21/2007	468.20
4/18/2007	467.80
5/23/2007	467.60
6/19/2007	467.40

WATER CONSERVATION – WELL MEASUREMENT – GROUND WATER

Reading for well No. **3872H**
 State Well No. **1N14W14F05**
 Latitude: **34-10-20**

Longitude: **118-19-18**

Thomas Guide Page: **563 F1**

WS_ELEV 2007-08	
5/27/2008	468.80
7/1/2008	469.90

WS_ELEV 2008-09	
09/30/2008	466.5
11/25/2008	466.0
1/7/2009	468.2
02/25/2009	468
04/29/2009	468.2
05/26/2009	467.3
06/29/2009	466
07/30/2009	466.5
8/26/2009	465.80
9/17/2009	465.60

WS_ELEV 2009-10	
10/21/2009	465
11/12/2009	465.1
12/15/2009	465.2
1/11/2010	465
2/22/2010	465.7
3/18/2010	466.1
4/22/2010	466.2
5/24/2010	465.9
6/14/2010	465.7
9/13/2010	464.2

WS_ELEV 2010-11	

WS_ELEV 2011-12	

WS_ELEV 2012-13	

WS_ELEV 2013-14	
10/29/2013	470.3
11/6/2013	470.3
12/11/2013	470.6
1/22/2014	470.4
2/18/2014	470.3
3/13/2014	470.5
4/15/2014	470.3
5/12/2014	470.1
6/26/2014	469.9
7/21/2014	470
8/26/2014	469.3
9/25/2014	468.8

WS_ELEV 2014-15	
10/20/2014	468.4
11/13/2014	468.3
12/18/2014	468.1
1/27/2015	468.4
2/17/2015	467.7
3/19/2015	467.2
4/16/2015	466.8
5/19/2015	466.6
6/11/2015	465.6
8/19/2015	465.5
9/22/2015	465.3

CUSTODIAN

Unpublished information and data may be obtained by contacting:

**County of Los Angeles
Department of Public Works
Water Resources Division
P.O. Box 1460
Alhambra, CA 91802-1460
(626) 458-6120**